

**22V, 6A Synchronous Step-Down COT Power Module**

April 2016

Rev. 1A

GENERAL DESCRIPTION

The XR79106 is part of a family of 22V synchronous step-down power modules combining the controller, drivers, inductor, passive components and MOSFETs in a single package for point-of-load supplies. This module requires very few external components leading to ease of design and fast time to market. The XR79106 has load current rating of 6A. A wide 4.5V to 22V input voltage range allows for single supply operation from industry standard 5V, 12V and 19.6V rails. With a proprietary emulated current mode Constant On-Time (COT) control scheme, the XR79106 provides extremely fast line and load transient response using ceramic output capacitors. It requires no loop compensation, simplifying circuit implementation and reducing overall component count. The control loop also provides 0.2% load and 0.2% line regulation and maintains constant operating frequency. A selectable power saving mode, allows the user to operate in Discontinuous Current Mode (DCM) at light current loads significantly increasing the converter efficiency. A host of protection features, including overcurrent, over temperature, short-circuit and UVLO, helps achieve safe operation under abnormal operating conditions. The XR79106 is available in a RoHS-compliant, green/halogen-free space-saving 8mm x 8mm x 4mm QFN package.

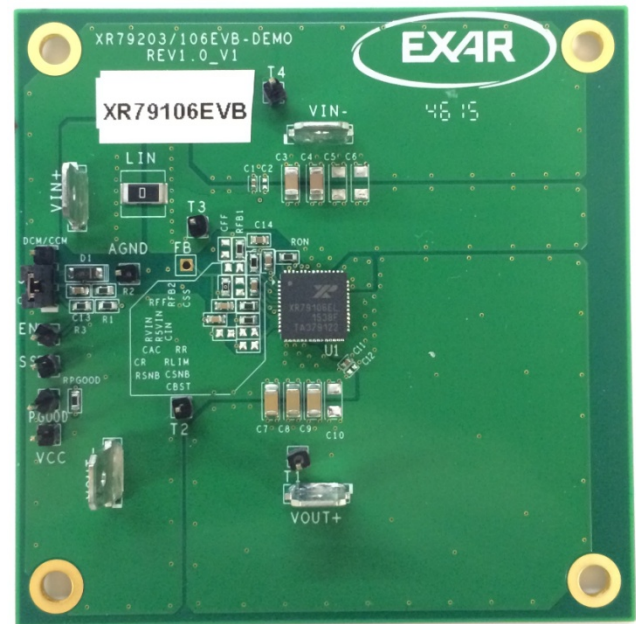
EVALUATION BOARD MANUAL**FEATURES**

- 6A step-down power module
 - 4.5V to 22V wide single input voltage
 - $\geq 0.6V$ adjustable output voltage
- Controller, drivers, inductor, passive components and MOSFETs integrated in one package
- Proprietary constant on-time control
 - No loop compensation required
 - Stable with ceramic output capacitors
 - Programmable 100ns to 1 μ s on-time
 - Constant 600kHz to 800kHz frequency
 - Selectable CCM or DCM/CCM operation
- Precision enable and power-good flag
- Programmable soft-start
- 8mm x 8mm x 4mm QFN package

**22V, 6A Synchronous Step-Down COT Power Module****PIN FUNCTIONS**

Pin Number	Pin Name	Type	Description
1	SS	A	Soft-start pin. Connect an external capacitor between SS and AGND to program the soft-start rate based on the 10 μ A internal source current.
2	PGOOD	OD, O	Power-good output. This open-drain output is pulled low when V _{OUT} is outside the regulation.
3	FB	A	Feedback input to feedback comparator. Connect with a set of resistors to V _{OUT} and AGND in order to program V _{OUT} .
4, 5, 53, 54, AGND Pad	AGND	A	Analog ground. Control circuitry of the IC is referenced to this pin. Connect to PGND.
6	VIN	PWR	IC supply input. Provides power to internal LDO. Connect to PVIN pins.
7	VCC	PWR	The output of LDO. Bypass with a 4.7 μ F capacitor to AGND.
8	PGND	PWR	Controller low-side driver ground. Connect with a short trace to closest PGND pins or PGND pad.
13-19, 39-43, PGND Pad	PGND	PWR	Ground of the power stage. Should be connected to the system's power ground plane.
9-12, 20-23, SW Pad	SW	PWR	Switching node. It internally connects the source of the high-side FET, the drain of the low-side FET, the inductor and bootstrap capacitor. Use thermal vias and/or sufficient PCB land area in order to heatsink the low-side FET and the inductor.
24-38, VOUT Pad	VOUT	PWR	Output of the power stage. Place the output filter capacitors as close as possible to these pins.
45-49, PVIN Pad	PVIN	PWR	Power stage input voltage. Place the input filter capacitors as close as possible to these pins.
50, 51, BST Pad	BST	A	Controller high-side driver supply pin. It is internally connected to SW via a 0.1 μ F bootstrap capacitor. Leave these pins floating.
52	ILIM	A	Overcurrent protection programming. Connect with a short trace to SW pins.
55	EN/MODE	I	Precision enable pin. Pulling this pin above 1.9V will turn the IC on and it will operate in forced CCM. If the voltage is raised above 3.0V, then the IC will operate in DCM or CCM depending on load.
56	TON	A	Constant on-time programming pin. Connect with a resistor to AGND.

NOTE:

A = Analog, I = Input, O = Output, OD = Open Drain, PWR = Power.

ORDERING INFORMATIONRefer to XR79106 datasheet and/or www.exar.com for exact and up to date ordering information.

**22V, 6A Synchronous Step-Down COT Power Module**

USING THE EVALUATION BOARD**POWERING UP**

Connect the VIN+/VIN- with short leads to power supply. Use T3 and T4 pins to monitor VIN+ and VIN- respectively. Connect VOUT+/VOUT- with short leads to an electronic load. Use T1 and T2 pins to monitor VOUT+ and VOUT- respectively. Apply 12V using the power supply. The XR79106 EVB should power up and regulate the output at 1.2V. Input voltage range is from 4.5V to 22V. Maximum rated current for XR79106 is 6A.

JUMPER J1

If the jumper is set to CCM position, the Module will operate in “forced CCM”. If the Jumper is set to DCM/CCM position the Module will operate in DCM at light load.

OPERATION FROM A 5V RAIL ($V_{IN}=4.5V-5.5V$)

For operation from a 5V rail it is recommended to tie output of the LDO to VIN by populating R5VIN with a 0Ω resistor. This enhances the operation of the drivers at $V_{IN}<5V$. Please remember to remove R5VIN for operation at higher V_{IN} .

PROGRAMMING THE OUTPUT VOLTAGE

V_{OUT} can be programmed by changing RFB1 according to:

$$RFB1 = RFB2 \times \left(\frac{V_{OUT}}{0.6} - 1 \right)$$

Where RFB2 has a nominal value of 2kΩ.



22V, 6A Synchronous Step-Down COT Power Module

EVALUATION BOARD SCHEMATICS

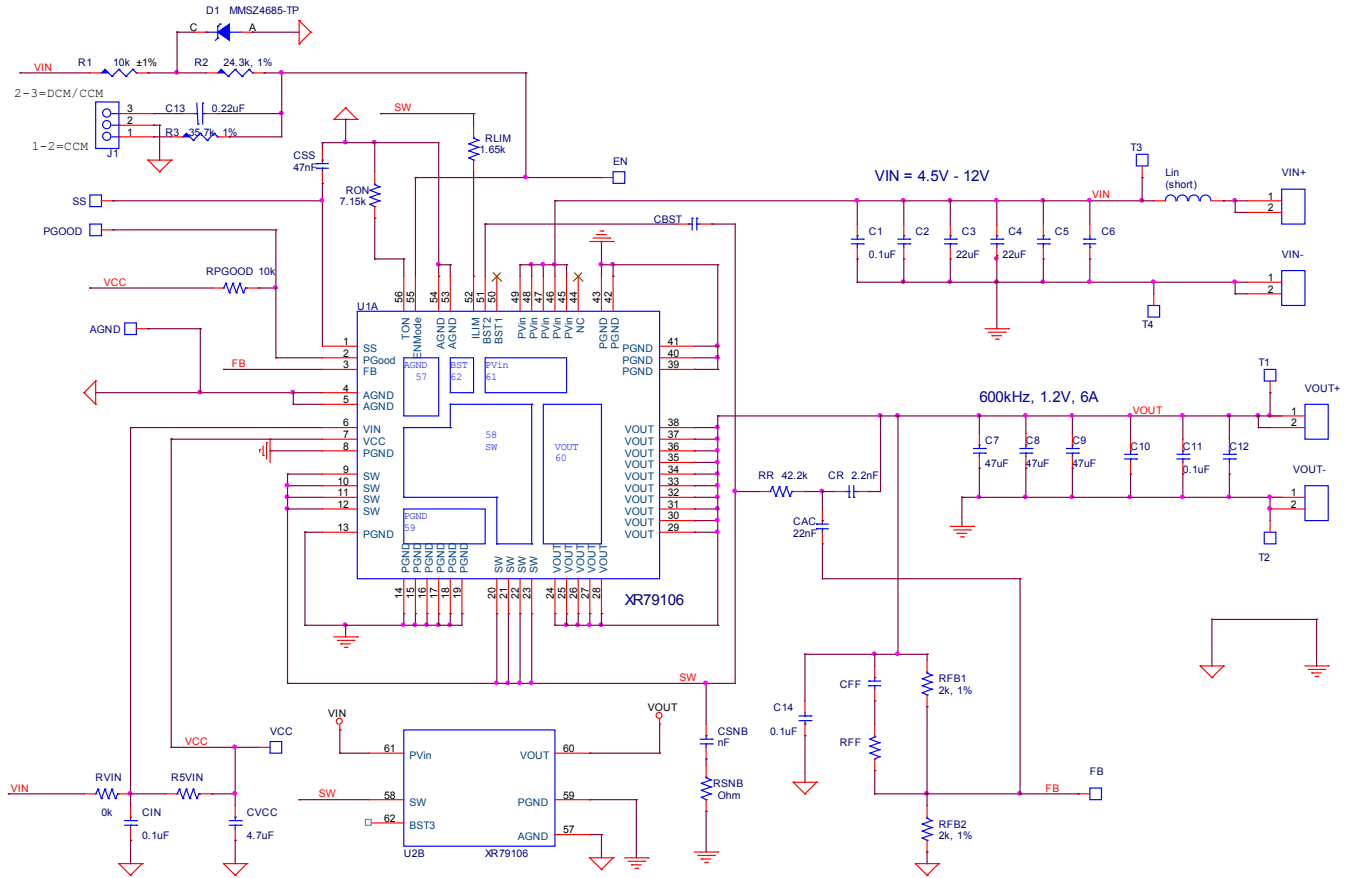

XR79106 EVB Schematics



22V, 6A Synchronous Step-Down COT Power Module

XR79106EVB BILL OF MATERIAL

PCB	1	Exar	146-6724-01		XR79106 Evaluation Board
U1	1	Exar	XR79106EL-F	8mmX8mm	
D1	1	ON SEMI	MMSZ4685T1G	SOD123	DIODE ZENER 3.6V 500MW SOD123
C3,C4	2	MURATA	GRM31CR61E226KE15L	1206	CERAMIC CAP. 22uF, 25V, X5R, 10%
C7,C8,C9	3	MURATA	GRM31CR61A476KE15L	1206	CERAMIC CAP. 47uF, 10V, X5R, 10%
C1,C11	2	MURATA	GRM155R71H104KE14D	0402	CERAMIC CAP. 0.1uF, 50V, X7R, 10%
CIN, C14	2	MURATA	GRM188R71H104KA93D	0603	CERAMIC CAP. 0.1uF, 50V, X7R, 10%
CVCC	1	MURATA	GRM188R61A475KE15D	0603	CERAMIC CER, 4.7uF, 10V, X5R, 10%
C13	1	MURATA	GRM188R71C224KA01D	0603	CERAMIC CAP , 0.22uF, 16V, X7R, 10%
CSS	1	MURATA	GRM188R71H473KA61D	0603	CERAMIC CAP , 47nF, 50V, X7R, 10%
CR	1	MURATA	GRM188R71H222KA01D	0603	CERAMIC CAP., 2200PF, 50V, X7R, 10%
CAC	1	MURATA	GRM188R71H223KA01D	0603	CERAMIC CAP., 22nF, 50V, X7R, 10%
R1,RPGOOD	2	PANASONIC	ERJ-3EKF1002V	0603	Resistor 10.0K Ohm, 1/10W,1%,SMD
R2	1	PANASONIC	ERJ-3EKF2432V	0603	Resistor 24.3K Ohm, 1/10W,1%,SMD
R3	1	PANASONIC	ERJ-3EKF3572V	0603	Resistor 35.7K Ohm, 1/10W,1%,SMD
RFB1,RFB2	2	PANASONIC	ERJ-3EKF2001V	0603	Resistor 2.0K Ohm, 1/10W,1%,SMD
RVIN	1	PANASONIC	ERJ-3GEY0R00V	0603	Resistor 0.00 Ohm, Jumper, 1/10W, SMD
RLIM	1	PANASONIC	ERJ-3EKF1651V	0603	Resistor 1.65K Ohm, 1/10W,1%,SMD
RR	1	PANASONIC	ERJ-3EKF4222V	0603	Resistor 42.2K Ohm, 1/10W,1%,SMD
RON	1	PANASONIC	ERJ-3EKF7151V	0603	Resistor 7.15K Ohm, 1/10W,1%,SMD
LIN	1	VISHAY/DALE	CRCW12100000Z0EAHP	2010	Resistor 0.00 Ohm, Jumper, 3/4W, SMD
T1-T4,VCC,PGOOD,SS,EN,AGND	9	Würth Elektronik	61300111121	2.54mm	Header 1 pin
J1	1	Würth Elektronik	61300311121	2.54mm	Header 3 pin
VIN-, VIN+, VOUT-, VOUT+	4	Würth Elektronik	7471287		Mountin Tab WA-MTAB



22V, 6A Synchronous Step-Down COT Power Module

EVALUATION BOARD LAYOUT

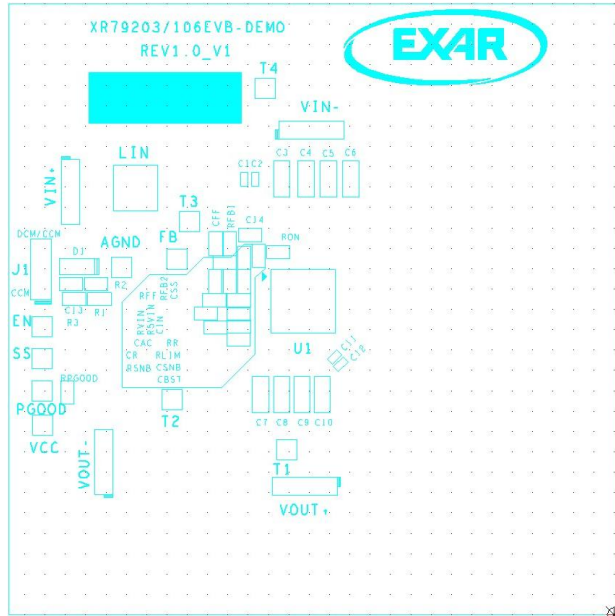

Fig. 3: Assembly Top

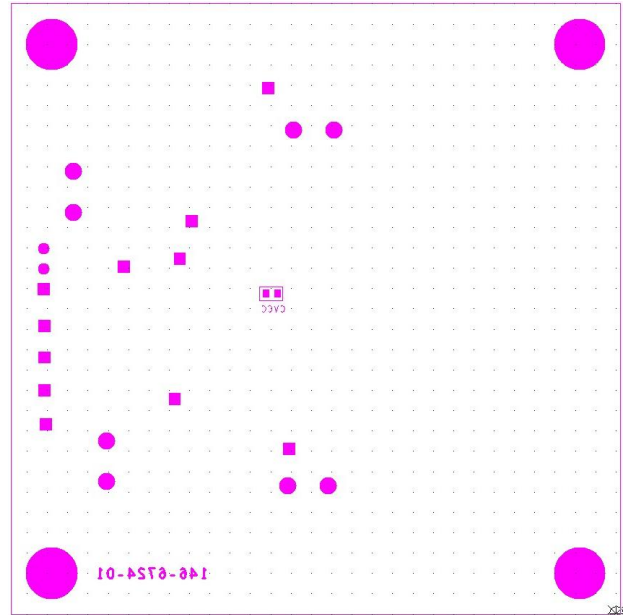

Fig. 4: Assembly Bottom

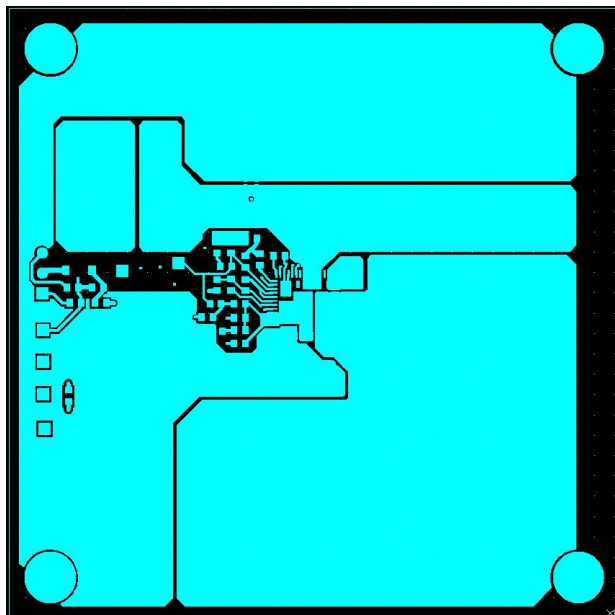

Fig. 5: Top Layer

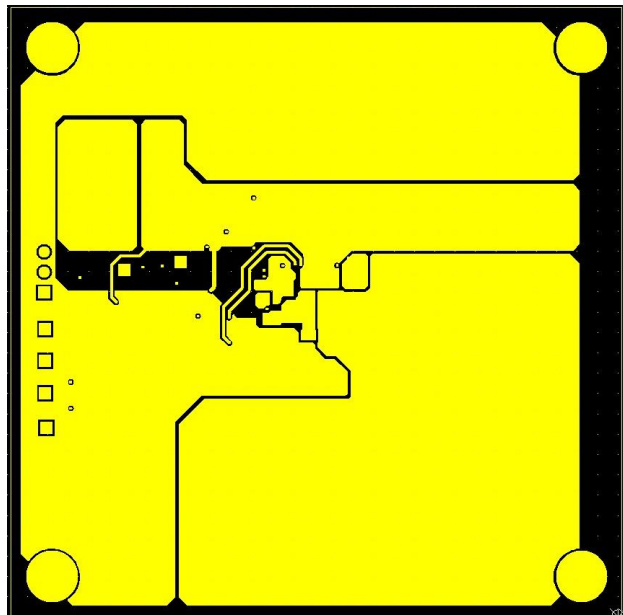

Fig. 6: Bottom Layer



22V, 6A Synchronous Step-Down COT Power Module

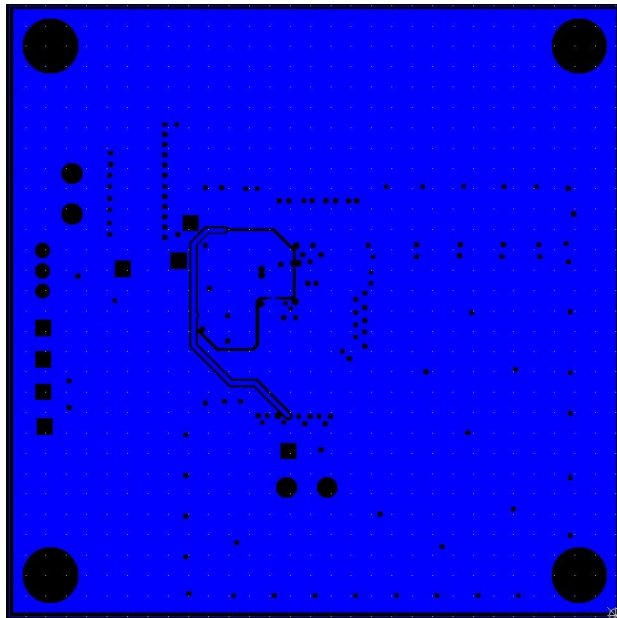

Fig. 7: Layer 2

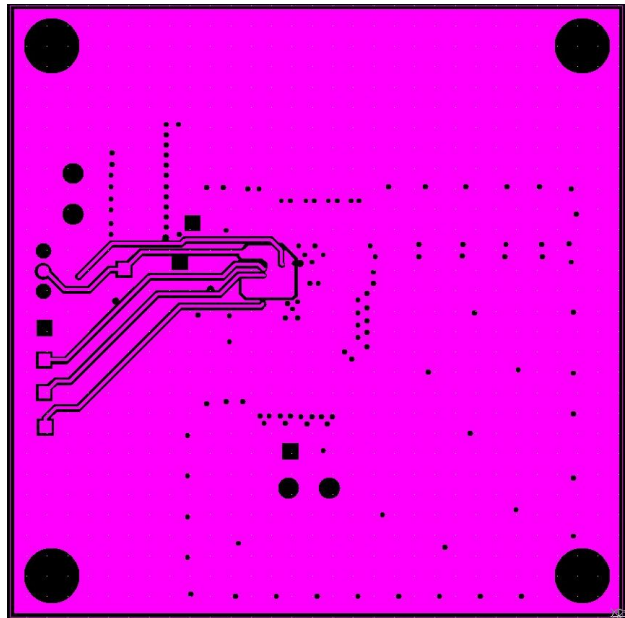

Fig. 8: Layer 3



22V, 6A Synchronous Step-Down COT Power Module

DOCUMENT REVISION HISTORY

Revision	Date	Description
1A	4/25/16	Initial release of document

BOARD REVISION HISTORY

Board Revision	Date	Description
REV 1.0	11/3/15	Initial release of evaluation board

FOR FURTHER ASSISTANCE

Email:

customersupport@exar.com

powertechsupport@exar.com

Exar Technical Documentation:

www.exar.com/technical-documentation



EXAR CORPORATION

HEADQUARTERS AND SALES OFFICES

48720 Kato Road

Fremont, CA 94538 – USA

Tel.: +1 (510) 668-7000

Fax: +1 (510) 668-7030

www.exar.com

NOTICE

EXAR Corporation reserves the right to make changes to the products contained in this publication in order to improve design, performance or reliability. EXAR Corporation assumes no responsibility for the use of any circuits described herein, conveys no license under any patent or other right, and makes no representation that the circuits are free of patent infringement. Charts and schedules contained herein are only for illustration purposes and may vary depending upon a user's specific application. While the information in this publication has been carefully checked; no responsibility, however, is assumed for inaccuracies.

EXAR Corporation does not recommend the use of any of its products in life support applications where the failure or malfunction of the product can reasonably be expected to cause failure of the life support system or to significantly affect its safety or effectiveness. Products are not authorized for use in such applications unless EXAR Corporation receives, in writing, assurances to its satisfaction that: (a) the risk of injury or damage has been minimized; (b) the user assumes all such risks; (c) potential liability of EXAR Corporation is adequately protected under the circumstances.

Reproduction, in part or whole, without the prior written consent of EXAR Corporation is prohibited.