

4

3

2

1

THIS DRAWING IS UNPUBLISHED.

RELEASED FOR PUBLICATION

NOV ,2005.

© COPYRIGHT 2005 BY TYCO ELECTRONICS CORPORATION. ALL RIGHTS RESERVED.

LOC E DIST B

REVISIONS

P	LTR	DESCRIPTION	DATE	DWN	APVD
A		FIRST REVISION	04NOV05	DK	JC

CODE
TYCO PRODUCT CODE
VALUE, TOL, DATE CODE

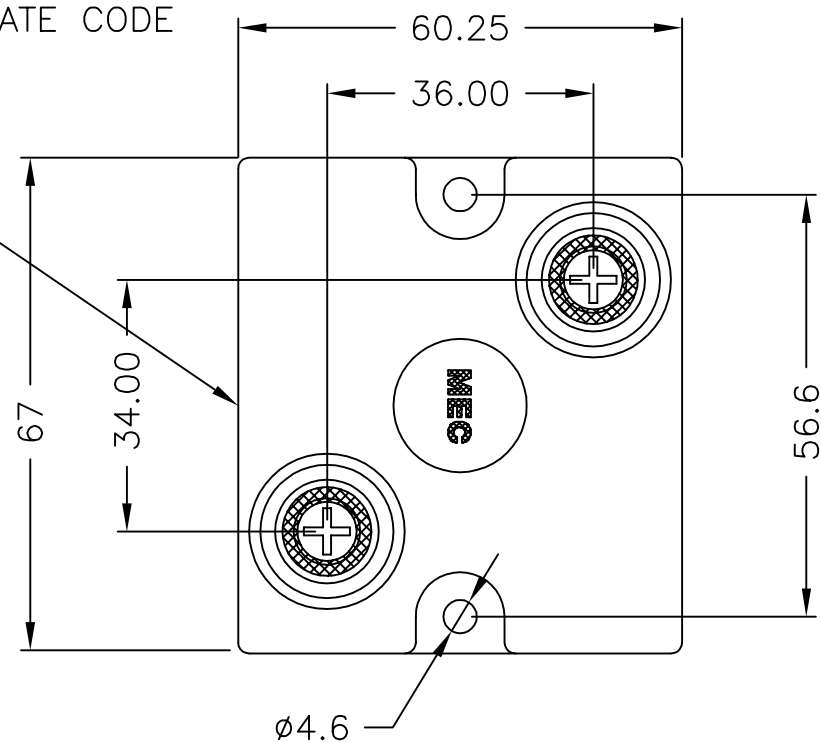

CODE
TYCO PRODUCT CODE
VALUE, TOL, DATE CODE

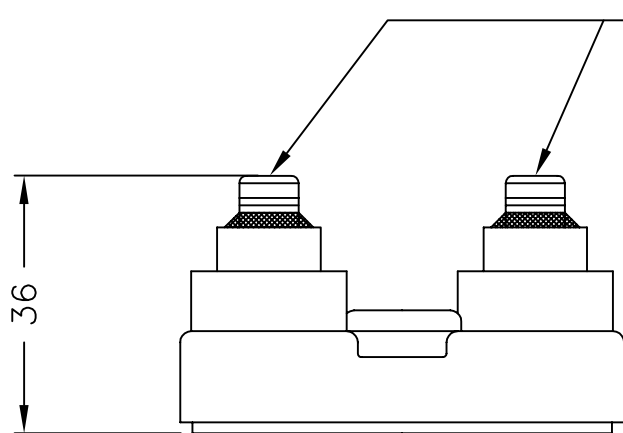
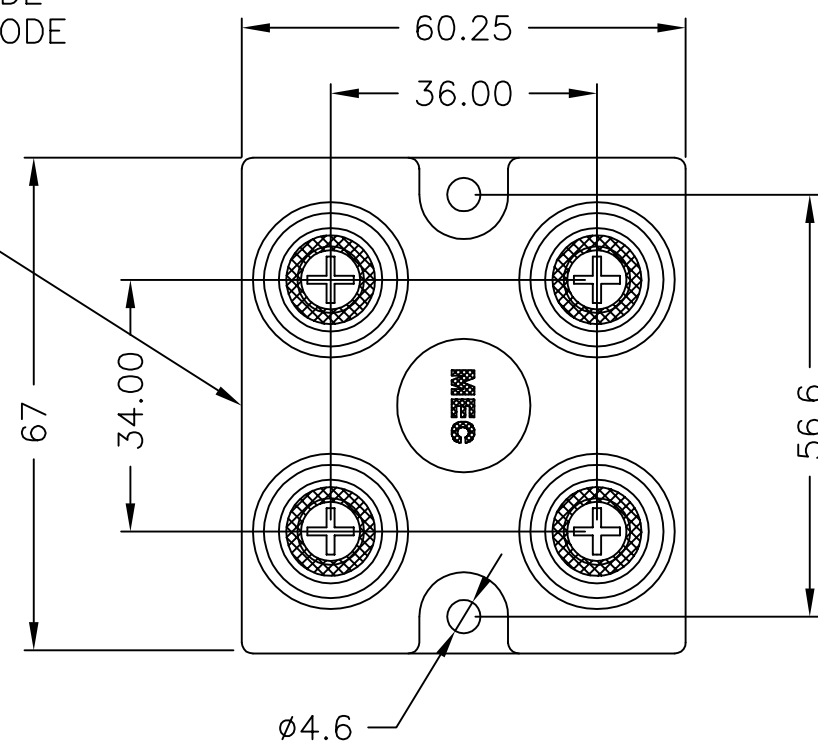

- 2 OFF M4 SCREWS
- 2 OFF M4 PLAIN WASHERS
- 2 OFF M4 SHAKEPROOF WASHERS

BDS2A250

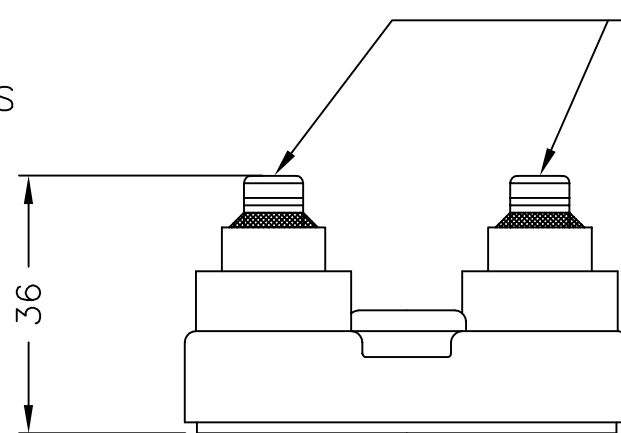

- 4 OFF M4 SCREWS
- 4 OFF M4 PLAIN WASHERS
- 4 OFF M4 SHAKEPROOF WASHERS

BDS4B250

FOR A SPECIFIC PN FOR A RESISTANCE VALUE AND TOLERANCE, PLEASE REFER TO DMF.

THIS DRAWING IS A CONTROLLED DOCUMENT.		DWN DAVE KENNEDY 03NOV05	tyco Tyco Electronics Corporation	
DIMENSIONS: MM		CHK J CATCHPOLE 04NOV05	Dorcan, Swindon, SN3 5HH	
TOLERANCES UNLESS OTHERWISE SPECIFIED:		APVD J CATCHPOLE 04NOV05	NAME BDS2A250 & BDS4B250	
0 PLC ± 0.5	1 PLC ± 0.2	PRODUCT SPEC	-	
2 PLC ± 0.1	3 PLC ± -	APPLICATION SPEC	-	
4 PLC ± -	ANGLES ± 5	WEIGHT	SIZE A3	CAGE CODE 00779
MATERIAL	FINISH	DRAWING NO C=1614770	RESTRICTED TO	
-	-	CUSTOMER DRAWING	SCALE NTS	SHEET 1 OF 1
			REV A	

Mouser Electronics

Authorized Distributor

Click to View Pricing, Inventory, Delivery & Lifecycle Information:

[TE Connectivity:](#)

[BDS2A25044RK](#)