

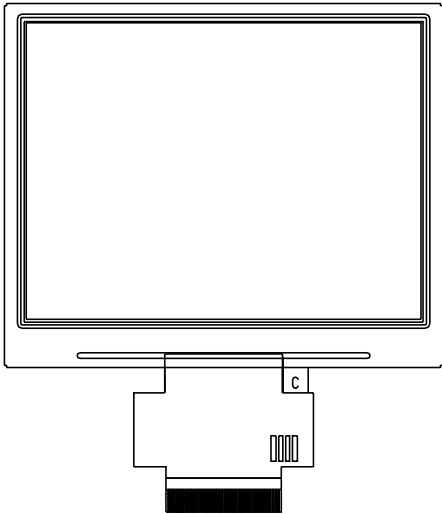

PRODUCT SPECIFICATION

# HDA350-3S

QVGA, TFT COLOR GRAPHICS  
LCD DISPLAY MODULE



HANTRONIX, INC. 10080 BUBB RD. CUPERTINO, CA 95014	Q.A.:	REV.:	HDA350-3S	SHEET 1 OF 16
	Z.W.	1.0		DATE: 10/19/12

## 1. GENERAL INFORMATION

Item	Contents	Unit
LCD Type	TFT TRANSMISSIVE	/
Viewing direction	12:00	O' Clock
Module Size (W - H)	77.80-64.50	mm <sup>2</sup>
Active area (W-H)	70.08-52.56	mm <sup>2</sup>
Number of Dots	320(RGB) *240	/
Driver IC	HX8238-D	/
Colors	16M	/
Interface	24-bits RGB	
Backlight type	LED	/
Operating voltage	VCC=3.3	V
Surface luminance	450	cd/m <sup>2</sup>

HANTRONIX, INC.  
10080 BUBB RD.  
CUPERTINO, CA 95014

Q.A.:  
Z.W.

REV.:  
1.0

**HDA350-3S**

SHEET 2 OF 16

DATE:  
10/19/12

### 3.ABSOLUTE MAXIMUM RATINGS

Symbol	Parameter	Spec.			Unit
		Min.	Typ.	Max.	
VDD	Supply Voltage	-0.3	-	2.7	V
VDDIO		-0.3	-	4.0	V
VCI	Input Voltage	VSS-0.3	-	5.0	V
I	Current Drain Per Pin Excluding VDD and VSS	-	25	-	mA

### 4.ELECTRICAL SPECIFICATION

Item	Symbol	Specification			Unit
		Min.	Typ	Max.	
TFT gate on voltage	V <sub>GH</sub>	-	+15	-	V
TFT gate off voltage	V <sub>GL</sub>	-	-10	-	V
TFT common electrode voltage	V <sub>comH</sub>	2.5	(3.6)	4.5	V
	V <sub>comL</sub>	-3	(-2.4)	0	

Note: (1) Vcom must be adjusted to optimize display quality: cross talk, contrast ratio and etc.

(2) VGH is TFT gate operating voltage

(3) VGL is TFT gate operating voltage

The storage capacitance structure of this product is Cst(Storage on Common).

The low voltage level of VGL signal must be fluctuated with same phase as Vcom. in case of Storage on Gate structure.

(4) Environmental condition: 25 ± 5 °C

### 5.BACKLIGHT CHARACTERISTICS

ITEM	SYMBOL	MIN.	TYP.	MAX.	UNIT	CONDITIONS
Forward Voltage	V <sub>f</sub>	9.0	10.2	10.8	V	I <sub>f</sub> = 20*2 mA
Forward Current	I <sub>f</sub>	--	20*2	---	mA	
Power Dissipation	P <sub>d</sub>		0.384		W	I <sub>f</sub> = 20*2 mA
Reverse Voltage	V <sub>R</sub>	--	--	3.0	V	
Reverse Current	I <sub>R</sub>			---	mA	
Luminous Intensity	I <sub>V</sub>	6000	--		cd/m <sup>2</sup>	I <sub>f</sub> = 20*2 mA
Luminous Uniformity		75	80		%	
Chromaticity coordinate		X=0.27		X=0.33		I <sub>f</sub> =20mA Ta=25°C Each chip
		Y=0.27		Y=0.33		

ITEM	SYMBOL	RATINGS
Operating Temperature Range	T <sub>opr</sub>	-30°C to +70°C
Storage Temperature Range	T <sub>sty</sub>	-40°C to +85°C

HANTRONIX, INC. 10080 BUBB RD. CUPERTINO, CA 95014	Q.A.:	REV.:	HDA350-3S	SHEET 3 OF 16
	Z.W.	1.0		DATE: 10/19/12

## 6. TIMING OF POWER SUPPLY

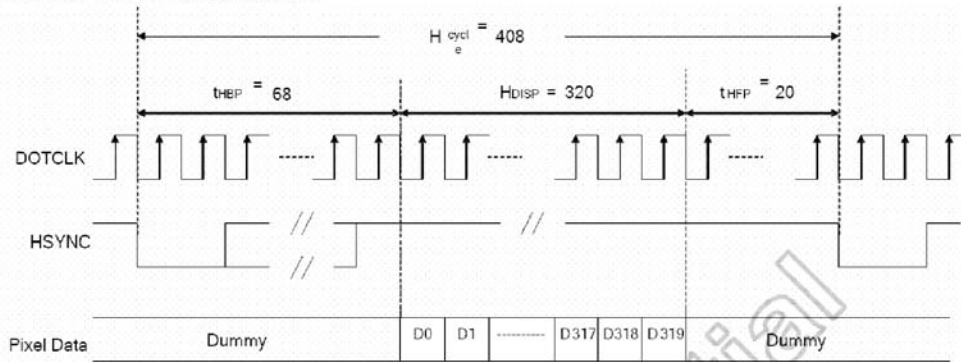

(a) Horizontal Data Transaction Timing

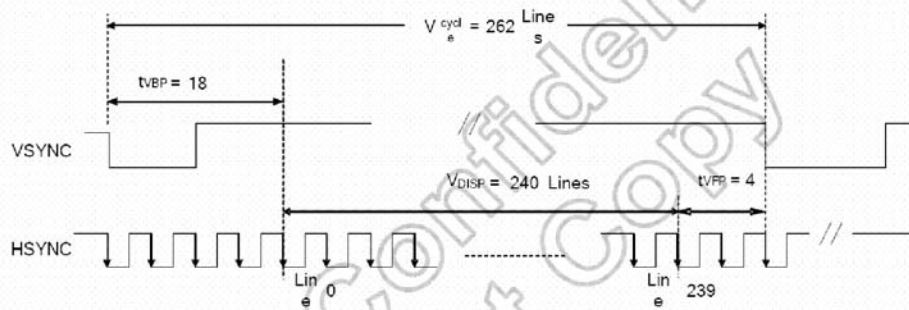

(b) Vertical Data Transaction Timing

### Data Transaction Timing in Parallel RGB (24 bit) Interface (SYNC Mode)

Characteristics	Symbol	Min.		Typ.		Max.		Unit
		24 bit	8 bit	24 bit	8 bit	24 bit	8 bit	
DOTCLK Frequency	fDOTCLK	-	-	6.5	19.5	10	30	MHz
DOTCLK Period	tDOTCLK	100	33.3	154	51.3	-	-	ns
Horizontal Frequency (Line)	fH	-	-	14.9	-	22.35	-	KHz
Vertical Frequency (Refresh)	fV	-	-	60	-	90	-	Hz
Horizontal Back Porch	tHBP	-	-	68	204	-	-	tDOTCLK
Horizontal Front Porch	tHFP	-	-	20	60	-	-	tDOTCLK
Horizontal Data Start Point	tHBP	-	-	68	204	-	-	tDOTCLK
Horizontal Blanking Period	tHBP + tHFP	-	-	88	264	-	-	tDOTCLK
Horizontal Display Area	HDISP	-	-	320	960	-	-	tDOTCLK
Horizontal Cycle	Hcycle	-	-	408	1224	450	1350	tDOTCLK
Vertical Back Porch	tvBP	-	-	18	-	-	-	Lines
Vertical Front Porch	tvFP	-	-	4	-	-	-	Lines
Vertical Data Start Point	tvBP	-	-	18	-	-	-	Lines
Vertical Blanking Period	tVBP + tvFP	-	-	22	-	-	-	Lines
Vertical Display Area	NTSC			240				Lines
	PAL			260(PALM=0)				
	PAL			268(PALM=1)				
Vertical Cycle	NTSC			262		350		Lines
	PAL			313				

Data Transaction Timing in Normal Operating Mode

HANTRONIX, INC. 10080 BUBB RD. CUPERTINO, CA 95014	Q.A.:	REV.:	HDA350-3S	SHEET 4 OF 16
	Z.W.	1.0		DATE: 10/19/12

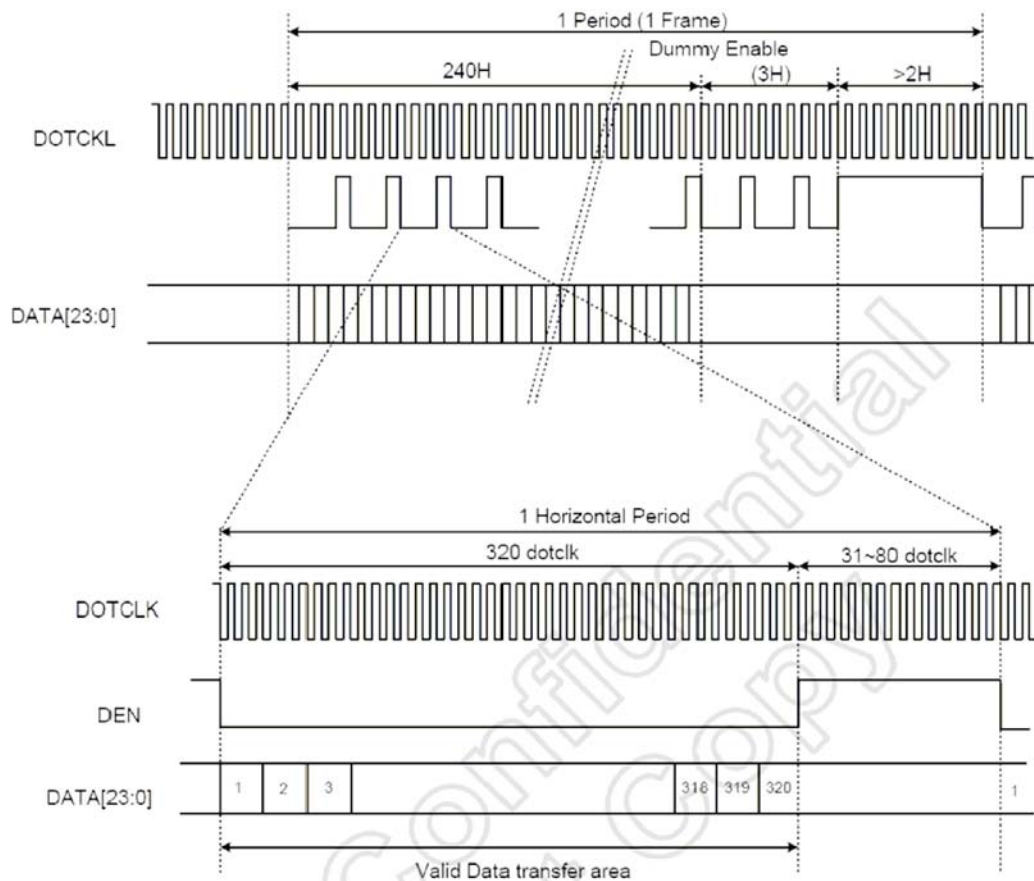

**Signal Timing in DE Mode**

## 7. OPTICAL SPECIFICATIONS

Item	Symbol	Conditions	Specifications			Unit	Note	
			Min.	Typ.	Max.			
Transmittance	T%	Viewing normal angle $(\theta_x = \theta_y = 0^\circ)$		7.4		%	All left side data are based on CMO's following condition -T6 NTSC: 60% LC:5091 Light : C light (Machine:BM5A) Normal Polarizer Without DBEF <b>"Simulation Data Reference Only"</b>	
Contrast Ratio	CR		200	300		--		
Response Time	$T_R$			15	30	ms		
	$T_F$			35	50	ms		
Chromaticity	Red		$X_R$	0.609	0.639	0.669		
			$Y_R$	0.314	0.344	0.374		
	Green		$X_G$	0.264	0.294	0.324		
			$Y_G$	0.557	0.587	0.617		
	Blue		$X_B$	0.102	0.132	0.162		
			$Y_B$	0.106	0.136	0.166		
	White	$X_W$	0.282	0.312	0.342			
		$Y_W$	0.319	0.349	0.379			
Viewing Angle	Hor.	$\theta_{X-}$		60		deg.		
		$\theta_{X+}$		60				
	Ver.	$\theta_{Y-}$		60				
		$\theta_{Y+}$		60				

\*Note (1) Definition of Contrast Ratio (CR):

The contrast ratio can be calculated by the following expression.

$$\text{Contrast Ratio (CR)} = L_{63} / L_0$$

L63: Luminance of gray level 63

L0: Luminance of gray level 0

$$CR = CR(10)$$

CR (X) is corresponding to the Contrast Ratio of the point X at Figure in Note (5).

\*Note (2) Definition of Response Time ( $T_R$ ,  $T_F$ ):

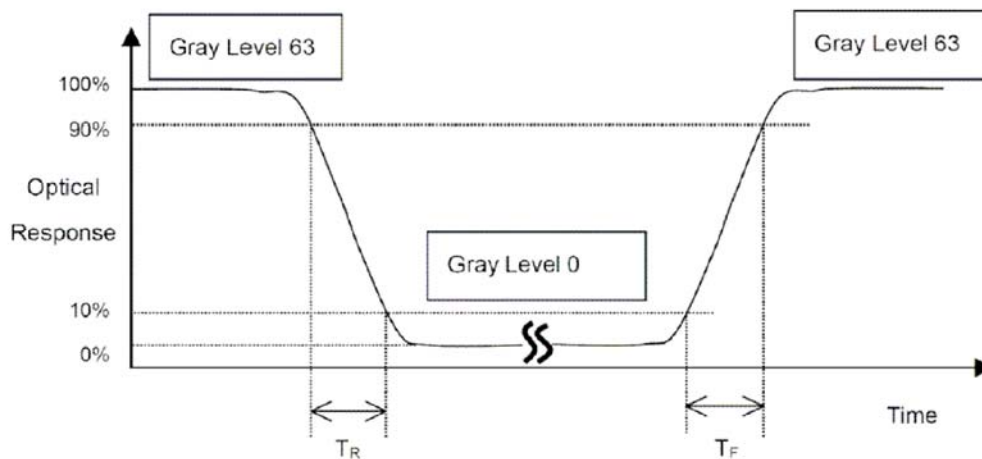

HANTRONIX, INC.  
10080 BUBB RD.  
CUPERTINO, CA 95014

Q.A.:  
Z.W.

REV.:  
1.0

HDA350-3S

SHEET 6 OF 16

DATE:  
10/19/12

\*Note(3) Definition of Viewing Angle

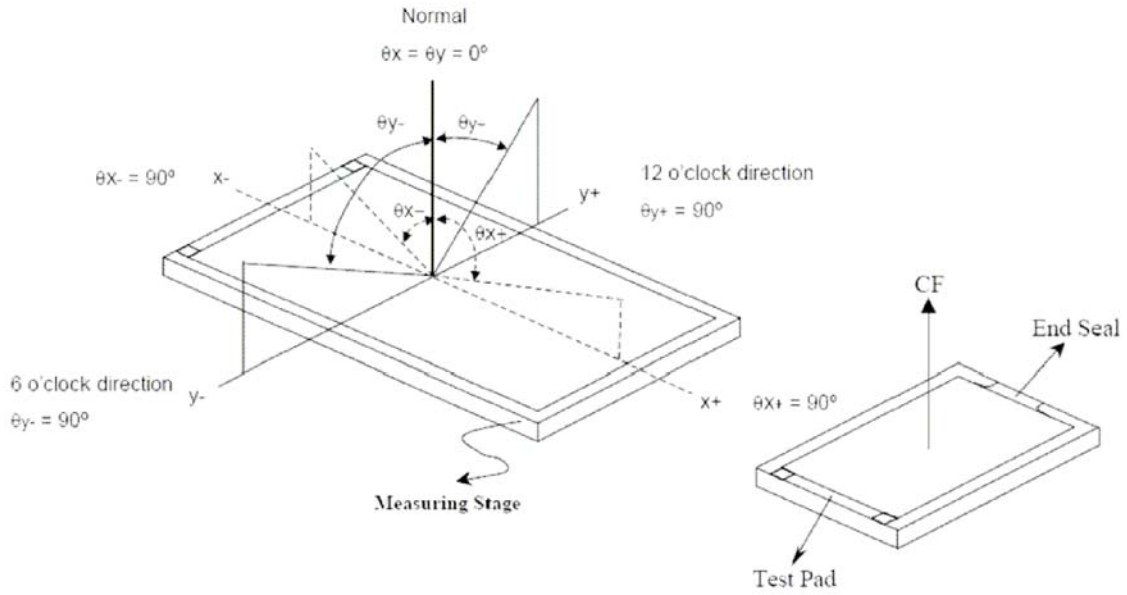

\*\*\* The above "Viewing Angle" is the measuring position with Largest Contrast Ratio: not for good image quality. View Direction for good image quality is 12 O'clock. Module maker can increase the "Viewing Angle" by applying Wide View Film.

\*Note (4) Measurement Set-Up:

The LCD module should be stabilized at a given temperature for 20 minutes to avoid abrupt temperature change during measuring. In order to stabilize the luminance, the measurement should be executed after lighting Backlight for 20 minutes in a windless room.

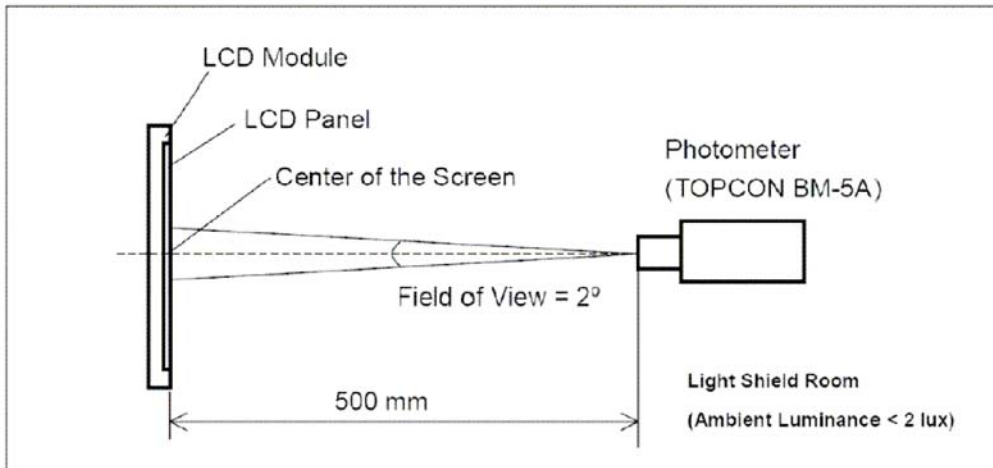

HANTRONIX, INC. 10080 BUBB RD. CUPERTINO, CA 95014	Q.A.:	REV.:	HDA350-3S	SHEET 7 OF 16
	Z.W.	1.0		DATE: 10/19/12

\*Note (5)

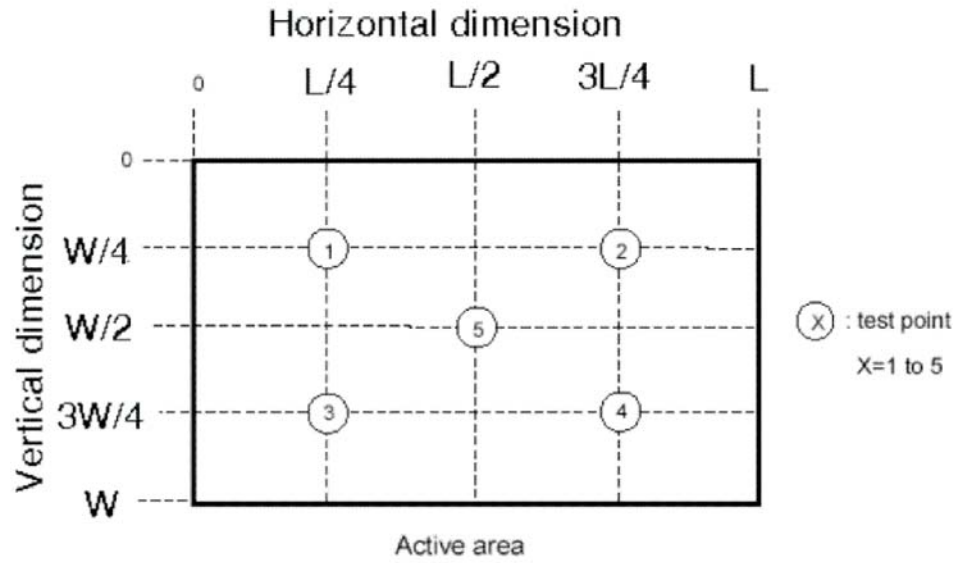

HANTRONIX, INC.  
10080 BUBB RD.  
CUPERTINO, CA 95014

Q.A.:  
Z.W.

REV.:  
1.0

HDA350-3S

SHEET 8 OF 16

DATE:  
10/19/12



## 8.INTERFACE DESCRIPTION

Pin No.	Symbol	Description
1	K	LED Backlight
2	A	LED Backlight
3	X2/NC	No Connection
4	Y2/NC	No Connection
5	X1/NC	No Connection
6	Y1/NC	No Connection
7	RESET	Reset pin.
8	CS	Chip select pin
9	SCL	Clock pin of serial interface
10	SDI	Data input pin in serial mode
11-18	BB0-BB7	Red Data
19-26	GG0-GG7	Green Data
27-34	RR0-RR7	Red Data
35	ENABLE	Display enable pin from controller
36	HSYNC	Line synchronization signal
37	VSYNC	Frame synchronization signal
38	DOTCLK	Dot-clock signal and oscillator source
39	VDD	Power supply
40	GND	Ground

## 9.APPLICATION CIRCUIT

Please consult our technical department for detail information.

## 10.INITIAL CODE

Please consult our technical department for detail information

HANTRONIX, INC. 10080 BUBB RD. CUPERTINO, CA 95014	Q.A.:	REV.:	HDA350-3S	SHEET 9 OF 16
	Z.W.	1.0		DATE: 10/19/12

## 11. RELIABILITY TEST

No.	Test Item	Test Condition	Inspection after test
1	High Temperature Storage	80±2°C/200 hours	Inspection after 2~4hours storage at room temperature,the sample shall be free from defects: 1.Air bubble in the LCD; 2.Sealleak; 3.Non-display; 4.missing segments; 5.Glass crack; 6.Current Idd is twice higher than initial value.
2	Low Temperature Storage	-30±2°C/200 hours	
3	High Temperature Operating	70±2°C/120 hours	
4	Low Temperature Operating	-20±2°C/120 hours	
5	Temperature Cycle	-20°C ~ 25°C~ 70°C × 10cycles (30min.) (5min.) (30min.)	
6	Damp Proof Test	50°C±5°C×90%RH/120 hours	
7	Vibration Test	Frequency : 10Hz~55Hz~10Hz Amplitude : 1.5mm, X , Y , Z direction for total 3hours	
8	Drooping test	Drop to the ground from 1m height, one time, every side of carton. (Packing condition)	
9	ESD test	Voltage: ±8KV R: 330Ω C: 150pF Air discharge, 10time	

**Remark:**

- 1.The test samples should be applied to only one test item.
- 2.Sample size for each test item is 5~10pcs.
- 3.For Damp Proof Test, Pure water(Resistance > 10MΩ) should be used.
- 4.In case of malfunction defect caused by ESD damage, if it would be recovered to normal state after resetting, it would be judge as a good part.
- 5.EL evaluation should be excepted from reliability test with humidity and temperature:  
Some defects such as black spot/blemish can happen by natural chemical reaction with humidity and Fluorescence EL has.
- 6.Failure Judgment Criterion: Basic Specification, Electrical Characteristic, Mechanical Characteristic, Optical Characteristic.
- 7.Please use automatic switch menu(or roll menu) testing mode when test operating mode.

HANTRONIX, INC. 10080 BUBB RD. CUPERTINO, CA 95014	Q.A.:	REV.:	<b>HDA350-3S</b>	SHEET 10 OF 16
	Z.W.	1.0		DATE: 10/19/12

## 12.INSPECTION CRITERION

OUTGOING QUALITY STANDARD	PAGE 1 OF 4
TITLE:FUNCTIONAL TEST & INSPECTION CRITERIA	

This specification is made to be used as the standard acceptance/rejection criteria for Color mobile phone LCM.

### 1 Sample plan

Sampling plan according to GB/T2828.1-2003/ISO 2859-1: 1999 and ANSI/ASQC Z1.4-1993, normal level 2 and based on:

Major defect: AQL 0.65

Minor defect: AQL 1.5

### 2. Inspection condition

Viewing distance for cosmetic inspection is about 30cm with bare eyes, and under an environment of 20~40W light intensity, all directions for inspecting the sample should be within

45° against perpendicular line.

### 3. Definition of inspection zone in LCD.

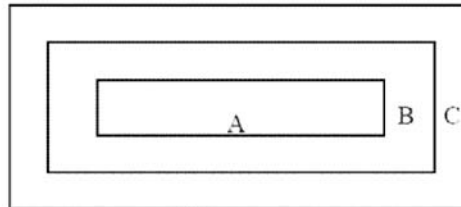

Zone A: character/Digit area

Zone B: viewing area except Zone A (ZoneA+ZoneB=minimum Viewing area)

Zone C: Outside viewing area (invisible area after assembly in customer's product)

Fig.1 Inspection zones in an LCD.

Note: As a general rule, visual defects in Zone C are permissible, when it is no trouble for quality and assembly of customer's product.

HANTRONIX, INC. 10080 BUBB RD. CUPERTINO, CA 95014	Q.A.:	REV.:	<b>HDA350-3S</b>	SHEET 11 OF 16
	Z.W.	1.0		DATE: 10/19/12

TITLE:FUNCTIONAL TEST & INSPECTION CRITERIA

**4. Inspection standards**

**4.1 Major Defect**

Item No	Items to be inspected	Inspection Standard	Classification of defects
4.1.1	All functional defects	1) No display 2) Display abnormally 3) Missing vertical, horizontal segment 4) Short circuit 5) Back-light no lighting, flickering and abnormal lighting.	Major
4.1.2	Missing	Missing component	
4.1.3	Outline dimension	Overall outline dimension beyond the drawing is not allowed.	

**4.2 Cosmetic Defect**

Item No	Items to be inspected	Inspection Standard	Classification of defects	
4.2.1	Clear Spots	For dark/white spot, size $\Phi$ is defined as $\Phi = (x+y)/2$	Minor	
				
	Black and white Spot defect Pinhole, Foreign Particle, Dirt under polarizer	1.		
		Zone		Acceptable Qty
		Size(mm)		A   B   C
		$\Phi \leq 0.10$		Ignore
		$0.10 < \Phi \leq 0.15$		2
	$0.15 < \Phi \leq 0.20$	1		
	$\Phi > 0.20$	0		
	Dim Spots	2.		Minor
Circle shaped and dim edged defects		2. Zone	Acceptable Qty	
		Size(mm)	A   B   C	
		$\Phi \leq 0.2$	Ignore	
		$0.20 < \Phi \leq 0.40$	3	
		$0.40 < \Phi \leq 0.60$	2	
		$0.60 < \Phi \leq 0.80$	1	
$0.80 < \Phi$	0			

HANTRONIX, INC.  
10080 BUBB RD.  
CUPERTINO, CA 95014

Q.A.:  
Z.W.

REV.:  
1.0

HDA350-3S

SHEET 12 OF 16

DATE: 10/19/12

TITLE: FUNCTIONAL TEST & INSPECTION CRITERIA

4.2. Cosmetic Defect

Item No	Items to be inspected	Inspection Standard					Classification of defects	
4.2.2	Line defect Black line, White line, Foreign material under polarizer,	Size(mm)		Acceptable Qty			Minor	
		L(Length)	W(Width)	Zone				
				A	B	C		
		Ignore	$W \leq 0.02$	Ignore				
		$L \leq 3.0$	$0.02 < W \leq 0.03$	2				
		$L \leq 2.0$	$0.03 < W \leq 0.05$	1				
	$0.05 < W$	Define as spot defect						
4.2.3	Polarizer scratch	<p>If the Polarizer scratch can be seen after mobile phone cover assembling or in the operating condition, judge by the line defect of 4.2.2.</p> <p>If the Polarizer scratch can be seen only in non-operating condition or some special angle, judge by the following.</p>					Minor	
		Size(mm)		Acceptable Qty				
		L(Length)	W(Width)	Zone				
				A	B	C		
		Ignore	$W \leq 0.03$	Ignore				
		$5.0 < L \leq 10.0$	$0.03 < W \leq 0.05$	2				
$L \leq 5.0$	$0.05 < W \leq 0.08$	1						
	$0.08 < W$	0						
4.2.4	Polarize Air bubble	Air bubbles between glass & polarizer					Minor	
		Size(mm)	2. Zone			Acceptable Qty		
			A	B	C			
		$\Phi \leq 0.2$	Ignore			Ignore		
		$0.20 < \Phi \leq 0.30$	2					
		$0.30 < \Phi \leq 0.50$	1					
$0.50 < \Phi$	0							

TITLE:FUNCTIONAL TEST & INSPECTION CRITERIA

4.3. Cosmetic Defect

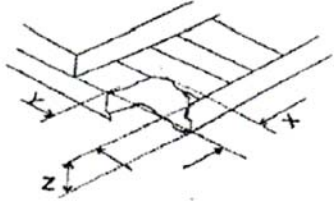
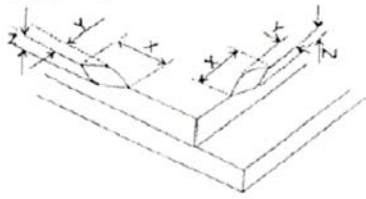
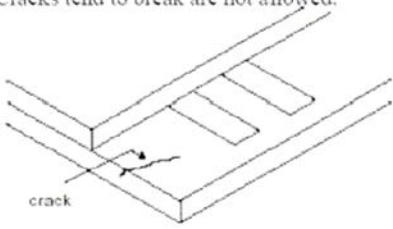
Item No	Items to be inspected	Inspection Standard	Classification of defects						
4.3.5	Glass defect	(i) Chips on corner  <table border="1" data-bbox="539 716 1042 793"> <tr> <td>X</td> <td>Y</td> <td>Z</td> </tr> <tr> <td>≤2.0</td> <td>≤S</td> <td>Disregard</td> </tr> </table> <p>Notes: S=contact pad length Chips on the corner of terminal shall not be allowed to extend into the ITO pad or expose perimeter seal.</p>	X	Y	Z	≤2.0	≤S	Disregard	Minor
		X	Y	Z					
		≤2.0	≤S	Disregard					
(ii) Usual surface cracks  <table border="1" data-bbox="522 1144 1058 1222"> <tr> <td>X</td> <td>Y</td> <td>Z</td> </tr> <tr> <td>≤3.0</td> <td>&lt;Inner border line of the seal</td> <td>Disregard</td> </tr> </table>	X	Y	Z	≤3.0	<Inner border line of the seal	Disregard	Minor		
X	Y	Z							
≤3.0	<Inner border line of the seal	Disregard							
(iii) Crack Cracks tend to break are not allowed. 	Major								
4.3.6	Parts alignment	1) Not allow IC and FPC/heat-seal lead width is more than 50% beyond lead pattern. 2) Not allow chip or solder component is off center more than 50% of the pad outline.	Minor						
4.3.7	SMT	According to the <Acceptability of electronic assemblies> IPC-A-610C class 2 standard. Component missing or function defect are Major defect, the others are Minor defect.							

Item No	Items to be inspected	Inspection Standard	Acceptable QTY		Classification of detects
			Visible	Non-visible	
4.4	White spot	1/2 Dot< $\Phi$ ≤ 1 Dot	0	Ignore	Major
	Black spot	1/2 Dot< $\Phi$ ≤ 1 Dot	1		
	Connected black spot	/	0		
Note	Name	Characteristic description			Badness Spot define
	White spot	Visibly shiny and size not changed spot viewed in black picture.			The spot (size≥ 1 Pixel*50%) define as one white black spot
	Black spot	Visibly dark and size not changed spot viewed in RGB picture.			
	Connected black spot	The connected two pixels display bad performance at the same time.			

1	K	21	CG2
2	A	22	CG3
3	X2/NC	23	CG4
4	Y2/NC	24	CG5
5	X1/NC	25	CG6
6	Y1/NC	26	CG7
7	RESET	27	RR0
8	CS	28	RR1
9	SCL	29	RR2
10	SDI	30	RR3
11	BB0	31	RR4
12	BB1	32	RR5
13	BB2	33	RR6
14	BB3	34	RR7
15	BB4	35	ENABLE
16	BB5	36	HSYNC
17	BB6	37	VSYNC
18	BB7	38	DOTCLK
19	CC0	39	VDD
20	CC1	40	CND

1	Operating Voltage:	Vcc=3.3V typ.
2	Resolution:	320RCB*240
3	Color:	16M
4	Interface:	24-bits RCB
5	Display type:	Transmissive
6	Viewing Direction:	12:00
7	Operating Temp:	-20°C~70°C
8	Storage Temp:	-30°C~80°C
9	Driver IC:	HX8238-D
10	Unspecified tolerance:	±0.2

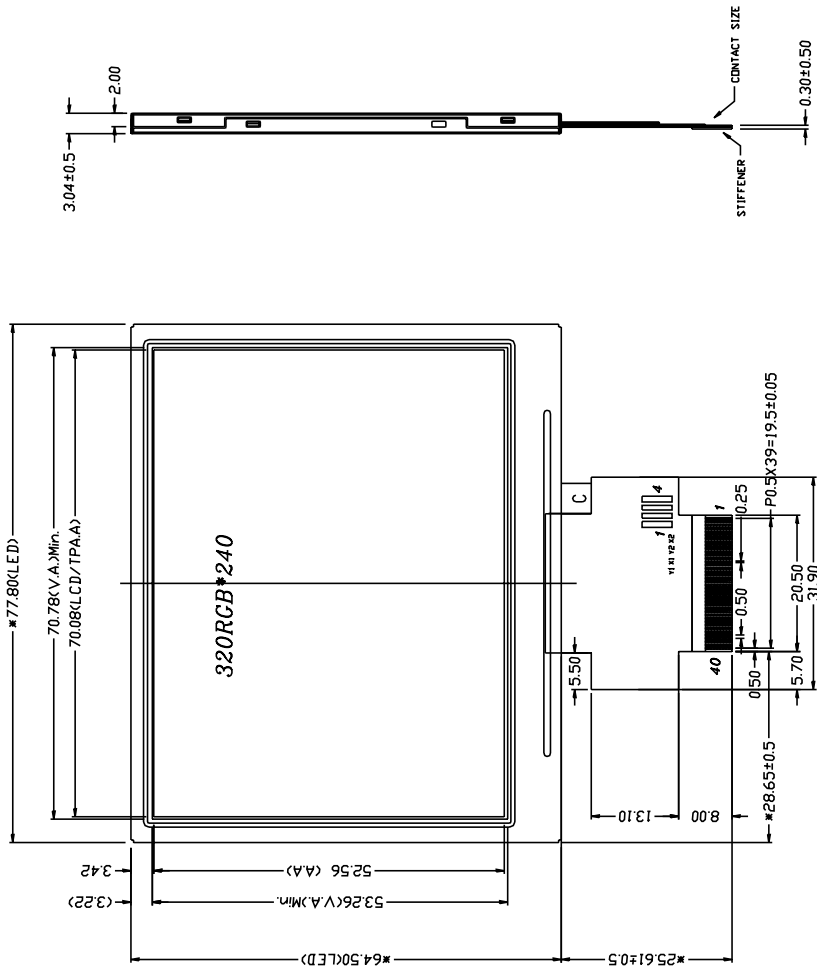

HANTRONIX, INC.  
10080 BUBB RD.  
CUPERTINO, CA 95014

Q.A.:  
Z.W.

REV.:  
1.0

HDA350-3S

SHEET 16 OF 16  
DATE: 10/19/12