

## Bi2 Series

### W

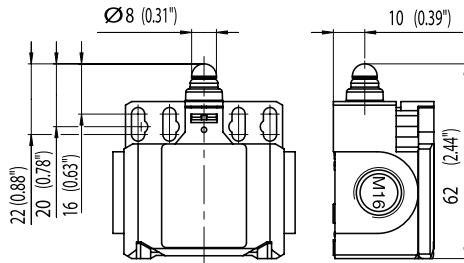

### RIW

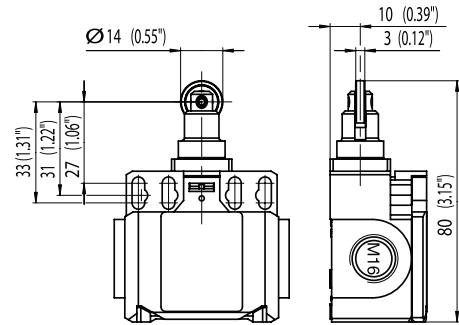

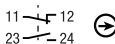
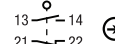
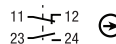
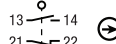
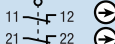
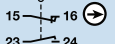
Switching Operation	Slow Action	Snap Action	Slow Action	Snap Action
<b>1 NC / 1 NO Contacts</b>	<b>608.5103.100</b> BI2-U1Z W 	<b>608.5153.107</b> BI2-SU1Z W 	<b>608.5117.101</b> BI2-U1Z RIW 	<b>608.5167.108</b> BI2-SU1Z RIW 
<b>2 NC Contacts</b>	<b>608.5803.116</b> BI2-A2Z W 	-	-	-
<b>2 NO Contacts</b>	-	-	-	-
<b>1 NC / 1 NO Contacts Overlapping</b>	<b>608.5303.115</b> BI2-UV1Z W 	-	-	-

### Technical Information

	Slow Action	Snap Action	Slow Action	Snap Action
Maximum Switching Voltage	240V	240V	240V	240V
Max. Switching Amps (up to)*	10A	10A	10A	10A
B10d (up to)*	20 Million	20 Million	20 Million	20 Million
Mechanical Service Life (up to)*	10 x 10 <sup>6</sup>	10 x 10 <sup>6</sup>	10 x 10 <sup>6</sup>	10 x 10 <sup>6</sup>
Switching Frequency	≤ 100/min	≤ 100/min	≤ 100/min	≤ 100/min
Operating Temperature	-30 °C to +80 °C	-30 °C to +80 °C	-30 °C to +80 °C	-30 °C to +80 °C
Protection Rating	IP65	IP65	IP65	IP65
Utilization Category (up to)*	AC-15, Ue/Ue 240V 3A	AC-15, Ue/Ue 240V 3A	AC-15, Ue/Ue 240V 3A	AC-15, Ue/Ue 240V 3A
Rate Insulation Voltage	400VAC	400VAC	400VAC	400VAC

Approvals

\* Depending on switching system - see technical information for details



**Special features/variants** (on request)

- Steel Roller Available