

### Features

- LO 2.0 TO 24 GHz
- RF 2.0 TO 24 GHz
- IF 1.0 TO 15 GHz
- LO DRIVE: +10 dBm (NOMINAL)
- HIGH COMPRESSION POINT

### Description

MY51 is a triple balanced mixer, designed for use in military, commercial and test equipment applications. The design utilizes Schottky ring quad diodes and broadband soft dielectric baluns to attain excellent performance. The use of high temperature solder assembly processes used internally makes it ideal for use in manual, semi-automated assembly. Environmental screening available to MIL-STD-883, MIL-STD-202 or MIL-DTL-28837, consult factory.

### Product Image



### Ordering Information

Part Number	Package
MY51	Versapac
MY51C	SMA Connectorized

### Electrical Specifications: $Z_0 = 50\Omega$ $Lo = +10$ dBm (Downconverter Application only)

Parameter	Test Conditions	Units	Typical	Guaranteed	
				+25°C	-54° to +85°C
SSB Conversion Loss (max) & SSB Noise Figure (max)	fR = 2.5 to 18 GHz, fL = 2 to 18 GHz, fI = 2 to 10 GHz fR = 2 to 18 GHz, fL = 2 to 24 GHz, fI = 1 to 12 GHz fR = 2 to 24 GHz, fL = 2 to 24 GHz, fI = 1 to 15 GHz	dB	7.5	9.5	10.0
			8.0	10.5	11.0
			9.0	11.5	12.0
Isolation, L to R (min)	fL = 2 to 3 GHz fL = 3 to 24 GHz	dB	20	15	13
			30	20	18
Isolation, L to I (min)	fL = 2 to 7 GHz fL = 7 to 24 GHz	dB	22	15	13
			30	20	18
1 dB Conversion Comp.	fL = +10 dBm	dBm	+5		
Input IP3	fR1 = 5 GHz at -6 dBm, fR2 = 5.01 GHz at -6 dBm, fL = 8 GHz at +10 dBm fR1 = 16 GHz at -6 dBm, fR2 = 16.01 GHz at -6 dBm, fL = 18 GHz at +10 dBm	dBm	+15		
			+15		

### Typical Performance Curves

**Conversion Loss vs. Frequency**  
LO @ +10 dBm

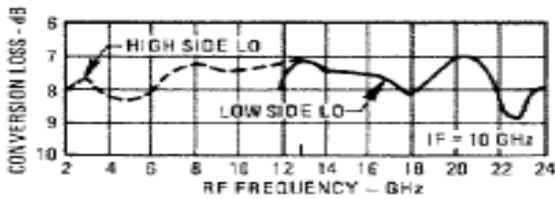
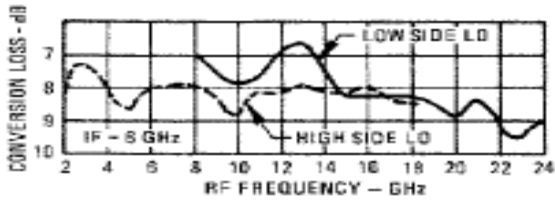
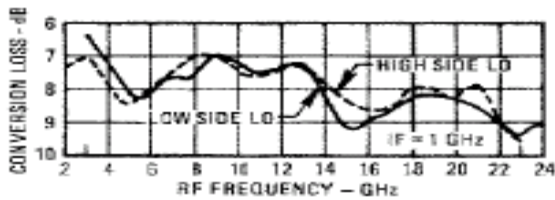

**I-Port VSWR**

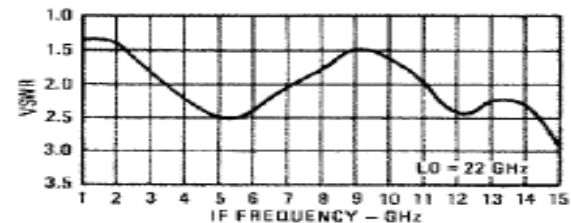
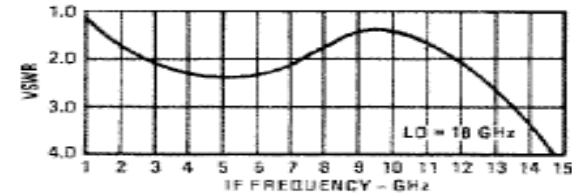
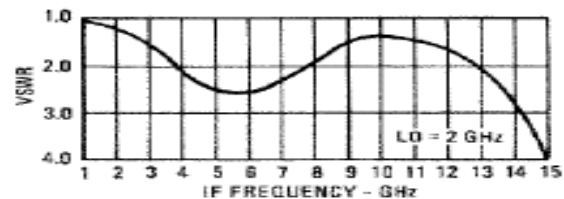

**L-Port VSWR**

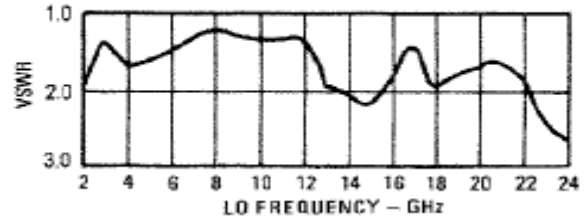

**R-Port VSWR**

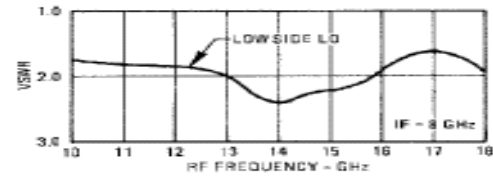
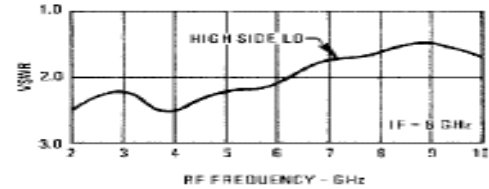

**R-Port VSWR**

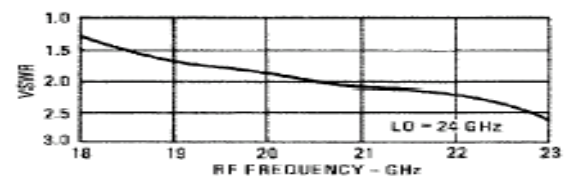
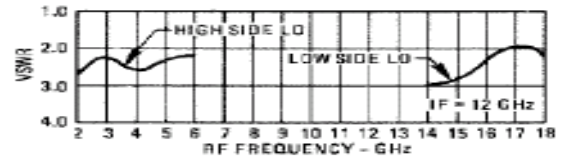

**R-Port VSWR LO @ +10 dBm**

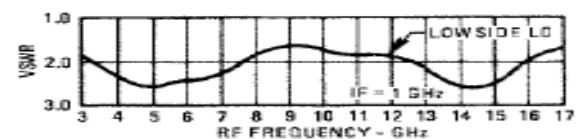
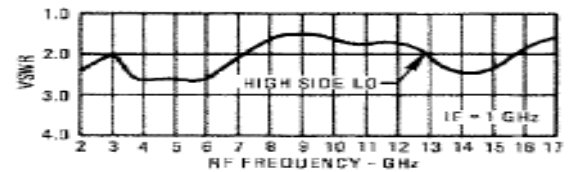

# MY51 / MY51C



## Triple-Balanced Mixer

Rev. V3

### Absolute Maximum Ratings

Parameter	Absolute Maximum
Operating Temperature	-54°C to +100°C
Storage Temperature	-65°C to +100°C
Peak Input Power	+26 dBm max @ +25°C +22 dBm max @ +100°C

### Outline Drawing: Versapac \*

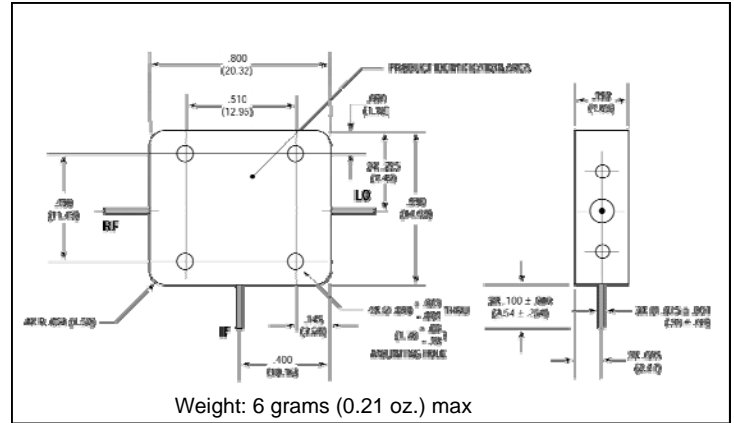

### Outline Drawing: SMA Connectorized \*

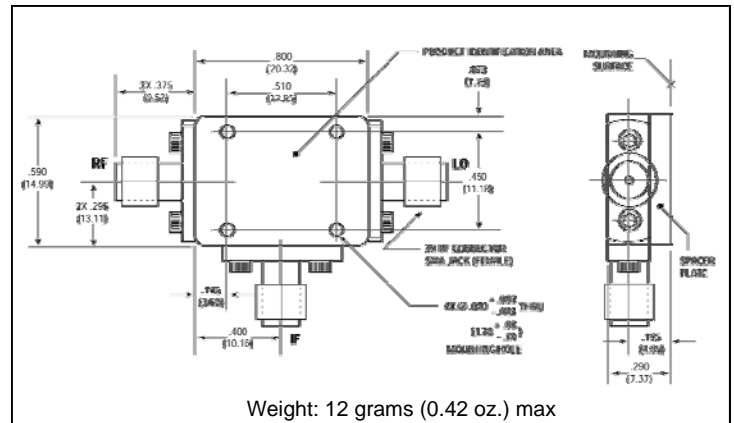

Drive Level

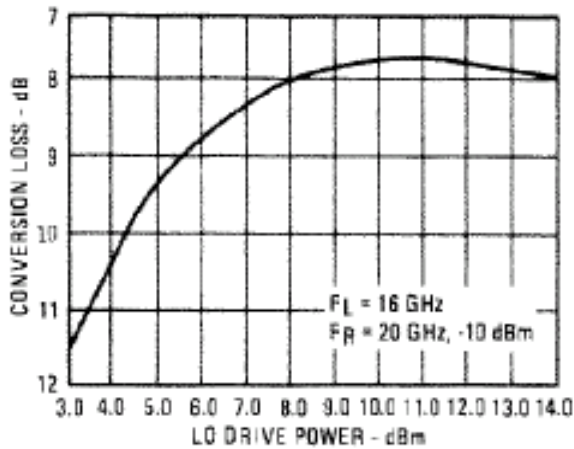

Isolation vs. Frequency

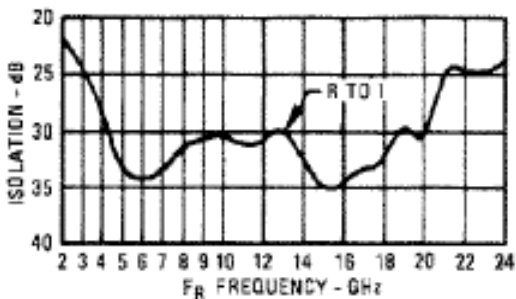
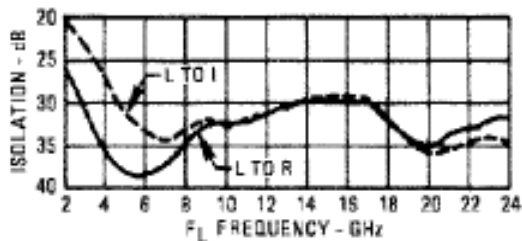

\* Dimensions are inches (millimeters)  $\pm 0.015$  (0.38) unless otherwise specified.