

Series 79 Micro-Crimp Section D: Cable Connectors, Crimp Termination



CABLE RECEPTACLES WITH PIN CONTACTS, CRIMP TERMINATION, 790-024P



Rugged, lightweight 790-024P connectors feature machined aluminum shells, fluorosilicone face seals and wire grommets for environmental protection. Contacts are rear-release snap-in crimp type. Connectors are supplied with crimp contacts packaged separately. Size #23 signal pins accept up to #22 AWG wire. Size #16 contacts accept #16-18 AWG wire. Size #12 contacts accept #12-14 AWG wire. Size 12 and 16 cavities also accept coaxial contacts purchased separately. Connector shell features a groove for attachment of a low-profile EMI backshell adapter 799-015, ordered separately.

HOW TO ORDER

Sample Part Number

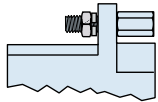
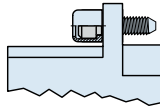
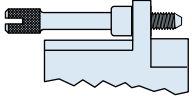
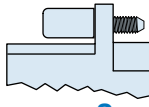
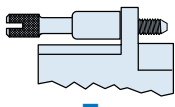
790-024P	C-13	M	P
Base Part Number	Shell Size - Insert Arr.	Shell Finish	Hardware Option
790-024P Cable Receptacle with Pin Contacts	See Table 1 for Available Insert Arrangements . To order a connector without size #16 or #12 power pins, substitute "W" instead of "P" in the insert arrangement. Example: 36P2 is supplied with 2 power pins. 36W2 is supplied less the power pins. See Section B for coaxial contacts purchased separately.	M Electroless Nickel <i>general purpose applications</i> MT Nickel-PTFE <i>1000 Hour Grey™ maximum corrosion protection and durability (non-reflective grey)</i> ZNU Zinc-Nickel with Black Chromate <i>tactical applications (non-reflective black)</i> Additional shell finishes are listed on page C-9.	<div style="display: flex; flex-wrap: wrap;"> <div style="width: 50%;">  <p>N Thru-Hole No Hardware</p> </div> <div style="width: 50%;">  <p>P Female Jackpost</p> </div> <div style="width: 50%;">  <p>L Low-Profile Captivated Jackscrew, Hex Head</p> </div> <div style="width: 50%;">  <p>K Slot-Head Extended Jackscrew</p> </div> <div style="width: 50%;">  <p>S Low-Profile Captivated Screwlock, Hex Head</p> </div> <div style="width: 50%;">  <p>T Slot-Head Extended Captivated Screwlock</p> </div> </div>

SPECIFICATIONS

Current Rating	#23 5 AMPS, #16 13 A., #12 23 A.
Dielectric Withstanding Voltage	#23 500 VAC RMS, #12 and #16 1800 VAC RMS
Insulation Resistance	5000 megohms minimum
Operating Temperature	-65° C. to +150° C.
Shock	300 g.
Vibration	37 g.

MATERIALS AND FINISHES

Shell	Aluminum alloy
Contacts	Copper alloy, 50 microinches gold plated
Insulators	Liquid crystal polymer (LCP)
Retention Clips	Beryllium copper alloy
Interfacial Seal, Grommet	Fluorosilicone rubber
Hardware	300 series stainless steel

Dimensions in inches (millimeters) and are subject to change without notice.

Table 1 Contact Arrangements

Layout	Contact Quantity			Face View
	#23	#16	#12	
A-5	5			
B-2P2	2			
B-9	9			
C-13	13			
D-15	15			
D-3P3	3			
D-7P2	5	2		
E-11P2	9	2		
E-19	19			
E-7P3	4	3		
F-15P2	13	2		
F-23	23			
F-5P5	5			
G-33	33			
H-10P4	6	4		
H-29P7	22	7		
H-36P2	34	2		
H-54P2	52	2		
H-5P5		5		
H-66	66			
J-17P4	13	4		
J-25P2	23	2		
J-33	33			
J-7P7	7			
K-27P4	23	4		
K-35P2	33	2		
K-43	43			
K-9P9	9			
L-6P6		6		

CROSS-SECTIONAL VIEW OF 790-024P



TABLE 2 HARDWARE OPTION

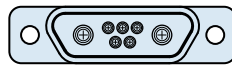

N

No Mating Hardware

Connector is supplied with thru-holes. Shell sizes H and L are .148" (3.76) diameter, other shell sizes are .092" (2.34) diameter. Accepts standard Micro-D M83513 hardware.



P

Jackposts

Connector is supplied with removable jackposts. Shell sizes H and L have #4-40 UNC thread, other sizes have #2-56 thread. Stainless steel. Conforms to M83513/05.

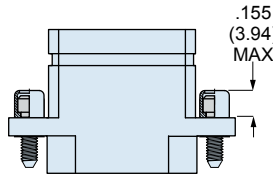

L

Hex Head Jackscrews

Connector is supplied with stainless steel non-removable low profile jackscrews. Shell sizes H and L have #4-40 UNC thread, other sizes have #2-56 thread.

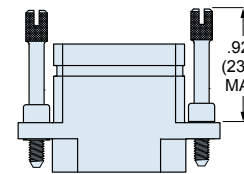

K

Extended Jackscrews

Connector is supplied with stainless steel slot head non-removable jackscrews. Shell sizes H and L have #4-40 UNC thread, other sizes have #2-56 thread.

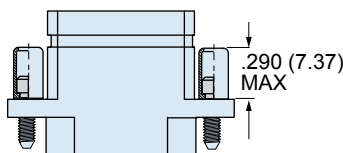

S

Hex Head Screwlocks

Connector is supplied with stainless steel non-removable low profile screwlocks. Shell sizes H and L have #4-40 UNC thread, other sizes have #2-56 thread. Screwlocks allow the connector to be mated before the screws are fastened.

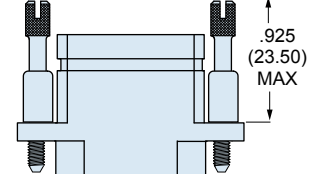

T

Extended Screwlocks

Connector is supplied with stainless steel non-removable slot head screwlocks. Shell sizes H and L have #4-40 UNC thread, other sizes have #2-56 thread. Screwlocks allow the connector to be mated before the screws are fastened.

Dimensions in inches (millimeters) and are subject to change without notice.

© 2009 Glenair, Inc.

CAGE Code 06324

Printed in U.S.A.

GLENAIR, INC. • 1211 AIR WAY • GLENDALE, CA 91201-2497 • 818-247-6000 • FAX 818-500-9912

www.glenair.com

D-2

E-Mail: sales@glenair.com

Rev. 04-July-2009

Series 79 Micro-Crimp Section D: Cable Connectors, Crimp Termination



790-024P DIMENSIONS

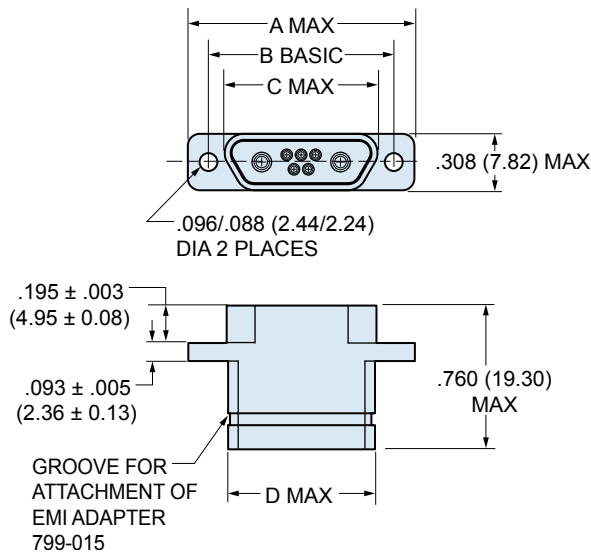

SHELL SIZES A, B, C, D, E, F, J, K



SHELL SIZE G



SHELL SIZE H AND L

790-024P DIMENSIONS

Shell Size	A Max.		B Basic		C Max.		D Max.		E Max.		F Basic		G Max.		H Max.	
	In.	mm.	In.	mm.	In.	mm.	In.	mm.	In.	mm.	In.	mm.	In.	mm.	In.	mm.
A	.785	19.94	.565	14.35	.400	10.16	.390	9.91	—	—	—	—	—	—	—	—
B	.935	23.75	.715	18.16	.551	14.00	.540	13.72	—	—	—	—	—	—	—	—
C	1.085	27.65	.865	21.97	.701	17.81	.690	17.53	—	—	—	—	—	—	—	—
D	1.185	30.10	.965	24.51	.801	20.35	.790	20.07	—	—	—	—	—	—	—	—
E	1.335	33.91	1.115	28.32	.951	24.16	.940	23.88	—	—	—	—	—	—	—	—
F	1.485	37.72	1.265	32.13	1.101	27.96	1.090	27.69	—	—	—	—	—	—	—	—
H	—	—	—	—	—	—	—	—	2.175	55.25	1.800	45.72	1.450	36.83	1.440	36.58
J	1.845	46.86	1.615	41.02	1.460	37.08	1.450	36.83	—	—	—	—	—	—	—	—
K	2.240	56.90	2.015	51.18	1.860	47.24	1.840	46.74	—	—	—	—	—	—	—	—
L	—	—	—	—	—	—	—	—	2.420	61.47	2.036	51.71	1.686	42.82	1.675	42.55

Dimensions in inches (millimeters) and are subject to change without notice.