



Package: SOT-89



### Product Description

RFMD's SBB3089Z is a high performance InGaP HBT MMIC amplifier utilizing a Darlington configuration with an active bias network. The active bias network provides stable current over temperature and process Beta variations. The SBB3089Z product is designed for high linearity 5V gain block applications that require excellent gain flatness, small size, and minimal external components. It is internally matched to 50Ω.

#### Optimum Technology Matching® Applied

- GaAs HBT
- GaAs MESFET
- InGaP HBT
- SiGe BiCMOS
- Si BiCMOS
- SiGe HBT
- GaAs pHEMT
- Si CMOS
- Si BJT
- GaN HEMT
- InP HBT
- RF MEMS
- LDMOS

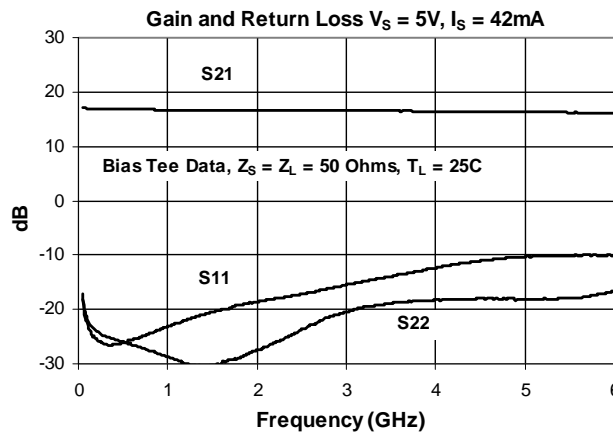

### Features

- Single Fixed 5V Supply
- Patented Self Bias Circuit and Thermal Design
- Gain = 16.4dBm at 1950MHz
- $P_{1dB} = 15.2dBm$  at 1950MHz
- $OIP_3 = 29.5dBm$  at 1950MHz
- Robust 1000V ESD, Class 1C HBM

### Applications

- PA Driver Amplifier
- Cellular, PCS, GSM, UMTS
- IF Amplifier
- Wireless Data, Satellite
- Wideband Instrumentation

Parameter	Specification			Unit	Condition
	Min.	Typ.	Max.		
Small Signal Gain	15.1	16.6	18.1	dB	850MHz
	14.9	16.4	17.9	dB	1950MHz
		16.3		dB	2400MHz
Output Power at 1dB Compression		15.6		dBm	850MHz
	14.2	15.2		dBm	1950MHz
		15.4		dBm	2400MHz
Output Third Order Intercept Point		30.0		dBm	850MHz
	27.5	29.5		dBm	1950MHz
		29.5		dBm	2400MHz
Input Return Loss	16	21		dB	1950MHz
Output Return Loss	19	25.5		dB	1950MHz
Noise Figure		3.9	4.9	dB	1950MHz
Device Operating Voltage		4.2	4.3	V	$R_{DC} = 20\Omega, V_S = 5.0V$
Device Operating Current	38	42	46	mA	$R_{DC} = 20\Omega, V_S = 5.0V$
Operational Current Range	30		46	mA	Per user preference via $R_{DC}$
Thermal Resistance		80		$^{\circ}C/W$	Junction to lead

Test Conditions:  $V_D = 4.2V, I_D = 42mA, T_L = 25^{\circ}C, OIP_3$  Tone Spacing = 1MHz,  $R_{DC} = 20\Omega$ , Bias Tee Data,  $Z_S = Z_L = 50\Omega, P_{OUT}$  per tone = -5dBm

## Absolute Maximum Ratings

Parameter	Rating	Unit
Max Device Current ( $I_D$ )	100	mA
Max Device Voltage ( $V_D$ )	6	V
Max RF Input Power* (See Note)	+20	dBm
Max Junction Temperature ( $T_J$ )	+150	°C
Operating Temperature Range ( $T_L$ )	-40 to +85	°C
Max Storage Temperature	+150	°C
ESD Rating - Human Body Model (HBM)	Class 1C	
Moisture Sensitivity Level	MSL 2	



**Caution!** ESD sensitive device.

Exceeding any one or a combination of the Absolute Maximum Rating conditions may cause permanent damage to the device. Extended application of Absolute Maximum Rating conditions to the device may reduce device reliability. Specified typical performance or functional operation of the device under Absolute Maximum Rating conditions is not implied.

RoHS status based on EU Directive 2002/95/EC (at time of this document revision).

The information in this publication is believed to be accurate and reliable. However, no responsibility is assumed by RF Micro Devices, Inc. ("RFMD") for its use, nor for any infringement of patents, or other rights of third parties, resulting from its use. No license is granted by implication or otherwise under any patent or patent rights of RFMD. RFMD reserves the right to change component circuitry, recommended application circuitry and specifications at any time without prior notice.

\*Note: Load condition  $Z_L = 50\Omega$

Operation of this device beyond any one of these limits may cause permanent damage. For reliable continuous operation, the device voltage and current must not exceed the maximum operating values specified in the table on page one.

Bias Conditions should also satisfy the following expression:

$$I_D V_D < (T_J - T_L) / R_{TH} + j - I \text{ and } T_L = T_{LEAD}$$

## Typical RF Performance at Key Operating Frequencies (Bias Tee Data)

Parameter	Unit	100 MHz	500 MHz	850 MHz	1950 MHz	2140 MHz	2400 MHz	3500 MHz
Small Signal Gain	dB	16.9	16.6	16.6	16.4	16.4	16.3	16.1
Output Third Order Intercept Point	dBm	29.5	30.5	30.0	29.5	29.0	29.5	27.0
Output Power at 1dB Compression	dBm	15.6	16.0	15.6	15.2	15.0	15.4	15.2
Input Return Loss	dB	24.0	26.5	24.5	21.0	20.5	20.0	15.5
Output Return Loss	dB	21.5	26.0	26.0	25.5	25.5	27.5	21.0
Reverse Isolation	dB	19.5	19.0	19.5	19.5	19.5	19.5	19.5
Noise Figure	dB	3.7	3.9	3.9	3.9	3.9	4.0	3.8

Test Conditions:  $V_D = 4.2V$   $I_D = 42mA$   $OIP_3$  Tone Spacing = 1MHz,  $P_{OUT}$  per tone = -5 dBm  $R_{DC} = 20\Omega$   $T_L = 25^\circ C$   $Z_S = Z_L = 50\Omega$

## Typical Performance with Bias Tees, $V_D = 5V$ with $R_{DC} = 20\Omega$ , $I_D = 42mA$

**OIP3 versus Frequency,**  
(-5dBm/tone, 1MHz spacing)

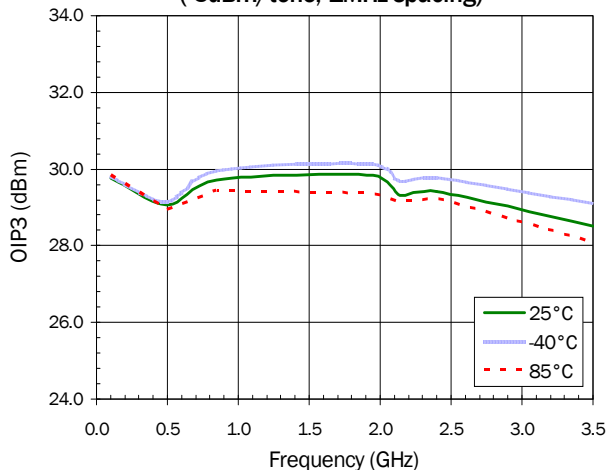

**P1dB versus Frequency**

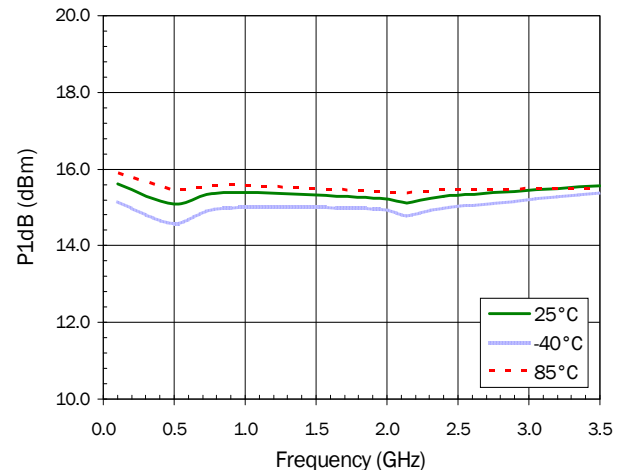

Typical Performance with Bias Tees,  $V_S=5V$ ,  $R_{DC}=20\Omega$ ,  $I_D=42mA$

**S11 versus Frequency**

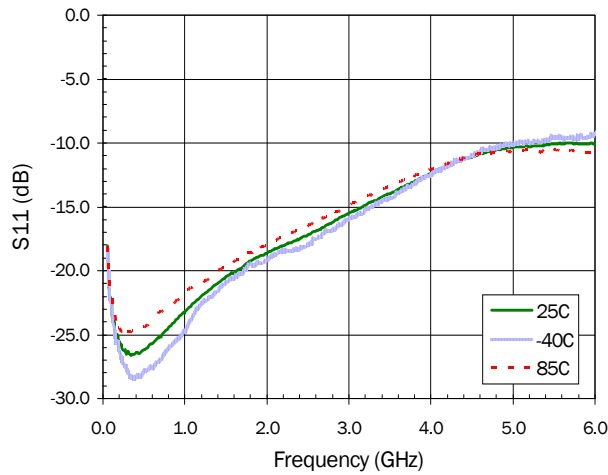

**S21 versus Frequency**

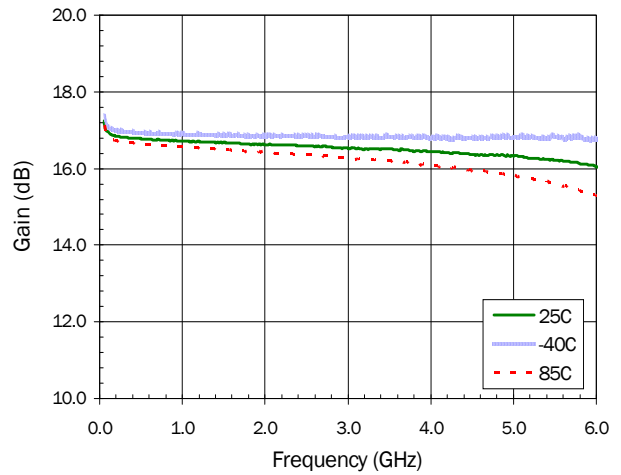

**S12 versus Frequency**

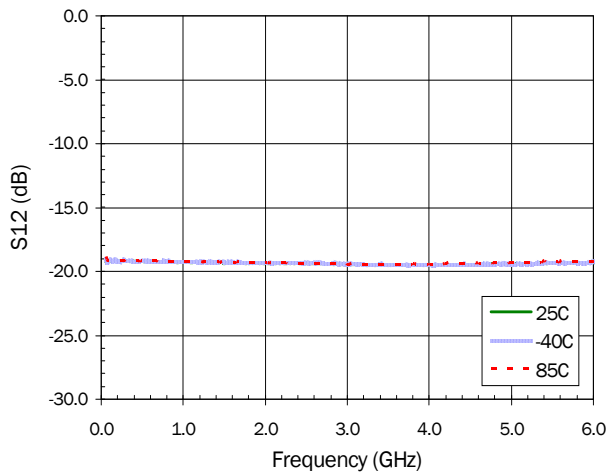

**S22 versus Frequency**

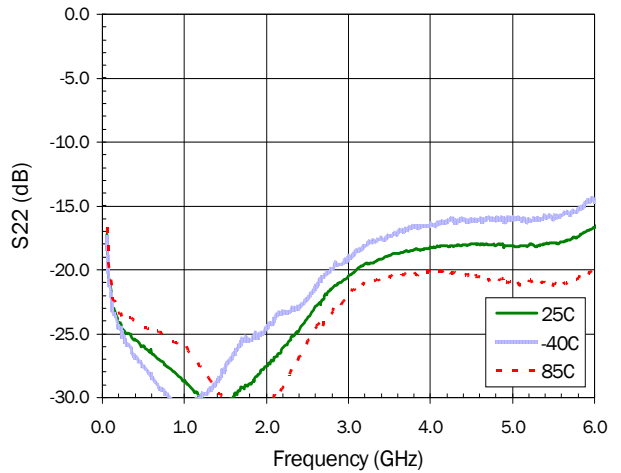

**NF versus Frequency**

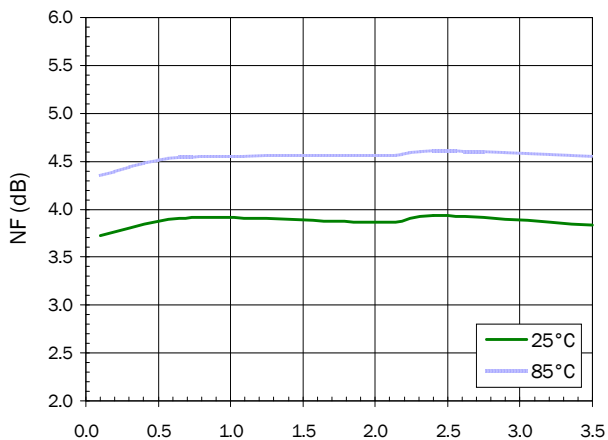

**DCIV**

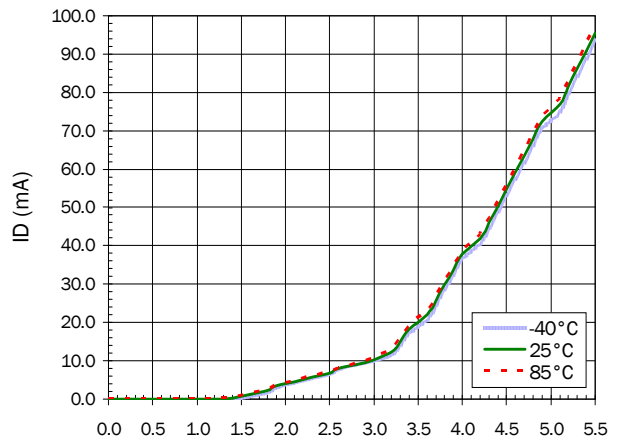

## Application Schematic

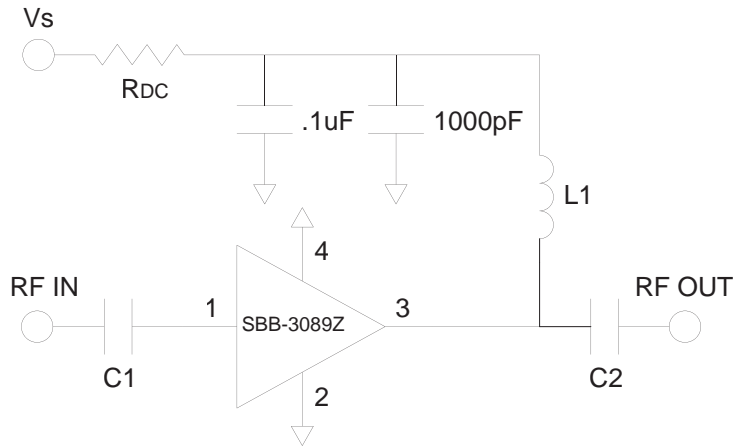

### Application Circuit Element Values

Reference Designator	500MHz to 3500MHz
C1	1000pF
C2	68pF
L1	48nH 0805HQ Coilcraft

## Evaluation Board Layout

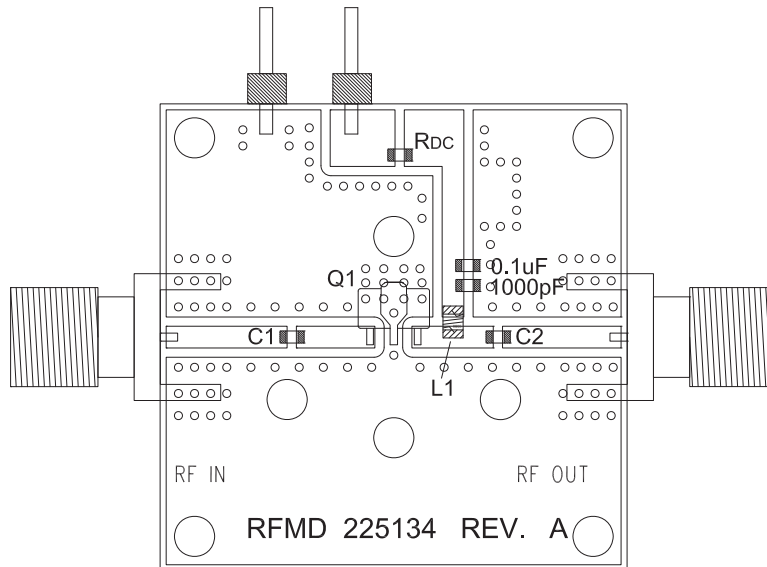

### Mounting Instructions

1. Solder the copper pad on the backside of the device package to the ground plane.
2. Use a large ground pad area with many plated through-holes as shown.
3. We recommend 1 or 2 ounce copper. Measurements for this data sheet were made on a 31mm thick FR-4 board with 1 ounce copper on both sides.

### Recommended Bias Resistor Values for $I_D = 42\text{mA}$ $R_{DC} = (V_S - V_D) / I_D$

Supply Voltage ( $V_S$ )	5V	6V	8V	10V	12V
$R_{DC}$	20 $\Omega$	43 $\Omega$	91 $\Omega$	139 $\Omega$	187 $\Omega$

Pin	Function	Description
1	RF IN	RF input pin. This pin requires the use of an external DC blocking capacitor chosen for the frequency of operation.
2, 4	GND	Connection to ground. Use via holes as close to the device ground leads as possible to reduce ground inductance and achieve optimum RF performance.
3	RF OUT/ DC BIAS	RF output and bias pin. This pin requires the use of an external DC blocking capacitor chosen for the frequency of operation.

### Part Identification

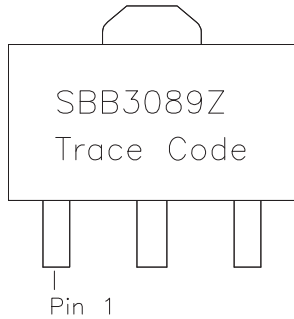

### Suggested Pad Layout

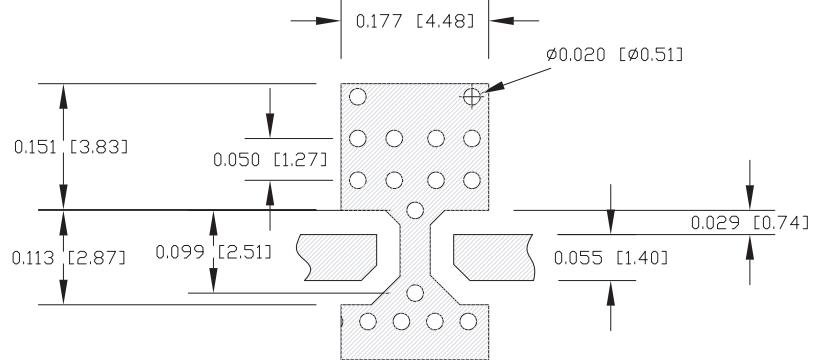

### Package Drawing

Dimensions in inches (millimeters)

Refer to drawing posted at [www.rfmd.com](http://www.rfmd.com) for tolerances.

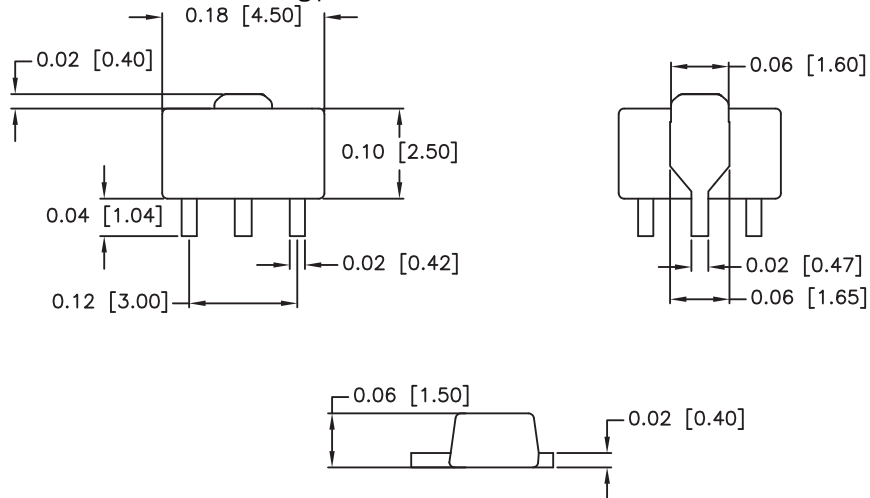

### Ordering Information

Ordering Code	Description
SBB3089Z	7" Reel with 1000 pieces
SBB3089ZSQ	Sample bag with 25 pieces
SBB3089ZSR	7" Reel with 100 pieces
SBB3089ZPCK1	500MHz to 3500MHz PCBA with 5-piece sample bag