

## General Description

The MAX40008/MAX40009 evaluation kit (EV kit) is a fully assembled and tested PC board that evaluates the MAX40008/MAX40009 single comparator with shutdown input. The MAX40009EVKIT# comes with a push-pull output (MAX40009ANT+), while the MAX40008EVKIT# EV kit comes with an open-drain output (MAX40008ANT+) installed that operates off a  $V_{DD}$  supply between 1.7V and 5.5V. The MAX40008/MAX40009 has a wide input common mode voltage range from -0.2V to  $V_{DD} + 0.2V$ . This EV kit demonstrates the MAX40008/MAX40009 in an ultra-small, 0.73mm x 1.1mm, 6-bump wafer-level package (WLP) with 0.35mm bump spacing.

The EV kit can be used to evaluate both the MAX40008 and MAX40009 with a 6-bump WLP. To evaluate the MAX40008 (open-drain output version on MAX40009EVKIT#), replace U1 (MAX40009) with the MAX40008 with jumper J1 installed.

When using the MAX40008EVKIT# to evaluate the MAX40009 (push-pull version), replace U1 (MAX40008) with MAX40009 with jumper J1 removed.

## Features

- 300ns Propagation Delay
- Wide Input Common Mode Voltage Range, -0.2V to  $V_{DD} + 0.2V$
- Hysteresis Adding Configurable
- Evaluates 6-Bump WLP Package
- Fully Assembled and Tested

[Ordering Information](#) appears at end of data sheet.

## Quick Start

### Required Equipment

- Three +5V DC power supplies ( $V_{DD}$ ,  $V_{IN+}$ , and  $V_{PULL}$ )
- Two digital multimeters (DMMs)

### Procedure

The MAX40008/MAX40009 EV kit is fully assembled and tested. Follow steps below to verify board operation. **Caution: Do not turn on the power supply until all connections are completed.**

- 1) Connect the positive terminal of a DC power supply to the VDD test point and the ground terminal to the GND test point.
- 2) Connect the positive terminal of a DC power supply to the VPULL test point and the ground terminal to the GND test point when evaluating the MAX40008. This is not necessary when evaluating the MAX40009.
- 3) Connect the positive terminal of a DC power supply to the INP test point and the ground terminal to the GND test point.
- 4) Turn on the  $V_{DD}$  power supply and set it to any voltage between 1.7V and 5.5V.
- 5) Turn on the  $V_{PULL}$  power supply and set it to any voltage between 1.7V to 5.5V (MAX40008 only). Do not need  $V_{PULL}$  supply when MAX40009 (push-pull output) is used.
- 6) Turn on the IN+ power supply and set it to the desired level.
- 7) Monitor the output using a DMM at the  $V_{OUT}$  test point and observe its response to varying voltage at IN+.  $V_{OUT}$  should be at logic-high ( $V_{PULL}$ ) when voltage applied on IN+ is greater than  $V_{IN-}$  and should be at logic-low (0V) when the voltage applied on IN+ is less than  $V_{IN-}$ .

### Detailed Description of Hardware

The MAX40008/MAX40009 EV kit is a fully assembled and tested PC board that evaluates the 6-bump WLP MAX40009ANT+ open-drain output comparator, while the MAX40008EVKIT# comes with an open-drain output (MAX40008ANT+). The EV kit requires a 1.7V to 5.5V supply voltage for normal operation. The EV kit can be used to evaluate both the MAX40008 and MAX40009 offered in a WLP package.

#### Positive Hysteresis

The EV kit allows user to add external hysteresis in addition to the 4mV internal hysteresis by usage of adding appropriate resistors on R2 and R1 pads. When R1 and R2 values are chosen in such a way that  $R1, R2 \gg R3$  (39kΩ) approximately greater 50x than R3, then the equations become:

For the MAX40008 (open-drain) output:

$$V_{THP+} = V_{IN} \frac{R2+R3}{R1+R2+R3} + V_{PULL} \frac{R1+R3}{R1+R2+R3}$$

and

$$V_{THN+} = V_{IN} \frac{R2}{R1+R2} + V_{OL} \frac{R1}{R1+R2}$$

when  $R1$  and  $R2 \gg R3$

$$V_{THP+} = V_{IN} \frac{R2}{R1+R2} + V_P \frac{R1}{R1+R2}$$

$$V_{HYS} = V_{THP} - V_{THN} =$$

$$V_{PULL} \frac{R1+R3}{R1+R2+R3} + V_{OL} \frac{R1}{R1+R2}$$

the term

$$V_{OL} \frac{R1}{R1+R2} \sim 0, \text{ so}$$

$$V_{HYS} = V_{PULL} \frac{R1+R3}{R1+R2+R3}$$

and R5 and R6 set the threshold voltage at IN- input as follows:

$$V_{IN-+} = V_{DD} \frac{R5}{R5+R6}$$

The source providing the signal input at IN+ input should be a low impedance source. High-impedance source affects the trip points as the input resistance of the source adds on to R1.

#### Logic Level Translation

Use the MAX40008 output for logic-level translation applications. Install jumper J1 and apply the desired supply voltage level at  $V_{PULL}$ . Resistors R5 and R6 set the threshold voltage at IN-. Apply the signal to be level translated at IN+. Note that the device's output has an absolute maximum of (-0.3V) to +6V. See [Table 1](#) for jumper configurations.

The pullup supply voltage ( $V_{PULL}$ ) can be up to 6V.

For evaluating the MAX40008 on the MAX40009EVKIT#, replace U1 (MAX40009ANT+) with MAX40008ANT+ and install jumper J1 to connect to  $V_{PULL}$ . When using the MAX40008EVKIT#, to evaluate MAX40009 (push-pull version), replace U1 (MAX40008) with MAX40009 with jumper J1 removed.

**Table 1. Jumper Settings**

JUMPER	SHUNT POSITION	FUNCTION
J1	Installed	Connects Open-Drain output (MAX40008) to $V_{PULL}$
	Not Installed*	Normal push-pull operation (MAX40009)
J2	1-2*	The device is in Active mode
	2-3	The device is shut down

\*Default Jumper settings

### Ordering Information

PART	TYPE
MAX40008EVKIT#	EV Kit
MAX40009EVKIT#	EV Kit

#RoHS-compliant

**MAX40008 EV Kit Bill of Materials**

ITEM	REF_DES	DNI/DNP	QTY	MFG PART #	MANUFACTURER	VALUE	DESCRIPTION	COMMENTS
1	C1, C2	-	2	CL05B104K05NHN	SAMSUNG ELECTRONICS	0.1UF	CAPACITOR; SMT (0402); CERAMIC; 0.1UF; .16V; TOL=10%; TG=55 DEGC TO +125 DEGC; TC=X7R	
2	X1, X2, GND	-	3	5001	KEYSTONE	N/A	TEST POINT; PIN DIA=0.1IN; TOTAL LENGTH=0.3IN; BOARD HOLE=0.04IN; BLACK; PHOSPHOR BRONZE WIRE SILVER PLATE FINISH;	
3	INM, INP, VOUT	-	3	5002	KEYSTONE	N/A	TEST POINT; PIN DIA=0.1IN; TOTAL LENGTH=0.3IN; BOARD HOLE=0.04IN; WHITE; PHOSPHOR BRONZE WIRE SILVER;	
4	J1	-	1	FTS-102-01-L-S	SAMTEC	FTS-102-01-L-S	CONNECTOR; MALE; THROUGH HOLE; 1.27MM MICRO LOW PROFILE TERMINAL STRIP; STRAIGHT; 2PINS;	
5	J2	-	1	FTS-103-01-L-S	SAMTEC	FTS-103-01-L-S	CONNECTOR; MALE; THROUGH HOLE; MICRO LOW PROFILE TERMINAL STRIP; STRAIGHT; 3PINS	
6	R1	-	1	ERJ-2GEOR00X	PANASONIC	0	RESISTOR; 0402; 0 OHM; 0%; JUMPER; 0.10W; THICK FILM	
7	R3	-	1	ERJ-2RKF3902X	PANASONIC	39K	RESISTOR; 0402; 39K OHM; 1%; 100PPM; 0.0625W; THICK FILM	
8	SU1, SU2	-	2	25N-BK-G	SAMTEC	25N-BK-G	TEST POINT; JUMPER; STR; TOTAL LENGTH=0.175IN; BLACK; INSULATION=PBT; PHOSPHOR BRONZE CONTACT=GOLD PLATED	
9	U1	-	1	MAX40008EWT+	MAXIM	MAX40008EWT+	EVKIT PART-IC; MAX40008EWT+; PACKAGE OUTLINE: 21-100086C; PACKAGE CODE: N60D1+1; WLP6	
10	VDD, VPULL	-	2	5000	KEYSTONE	N/A	TEST POINT; PIN DIA=0.1IN; TOTAL LENGTH=0.3IN; BOARD HOLE=0.04IN; RED; PHOSPHOR BRONZE WIRE SILVER PLATE FINISH;	
11	R2, R5, R6	DNP	0	ERJ-2GEOR00X	PANASONIC	0	RESISTOR; 0402; 0 OHM; 0%; JUMPER; 0.10W; THICK FILM	
12	PCB	-	1	MAX40008	MAXIM	PCB	PCB Board:MAX40008 EVALUATION KIT	
TOTAL			18					

MAX40008 EV Kit Schematic

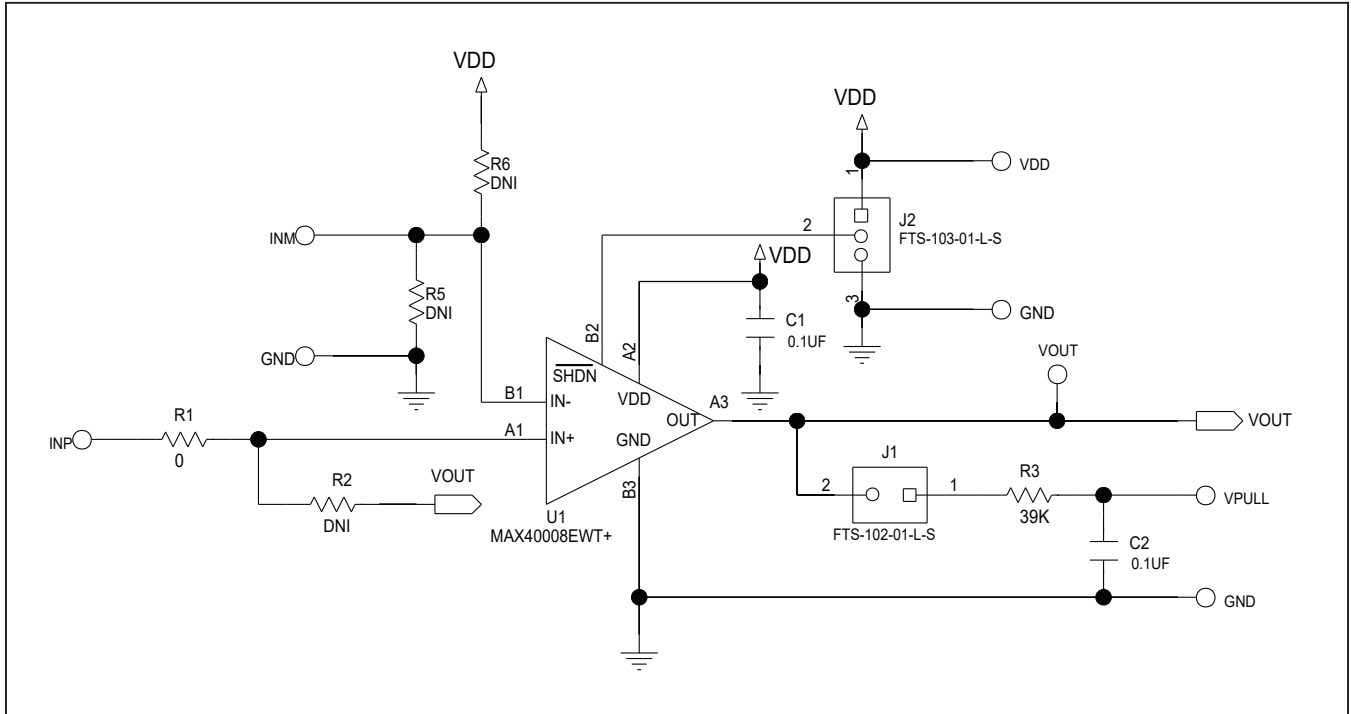

MAX40008 EV Kit PCB Layout Diagrams

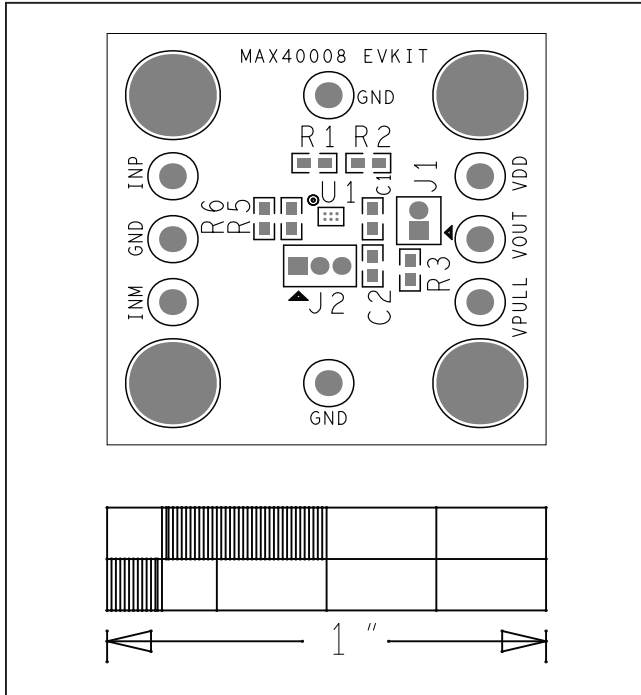

MAX40008 EV Kit—Top Silkscreen

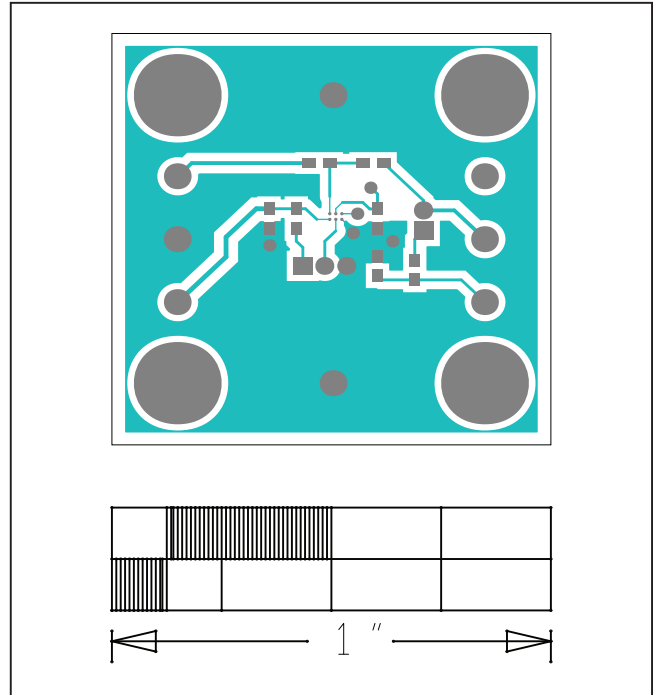

MAX40008 EV Kit—Top

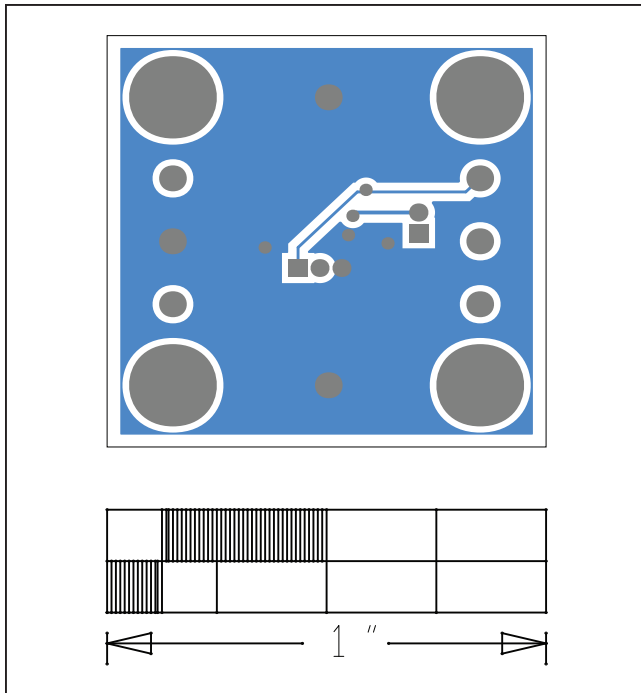

MAX40008 EV Kit—Bottom

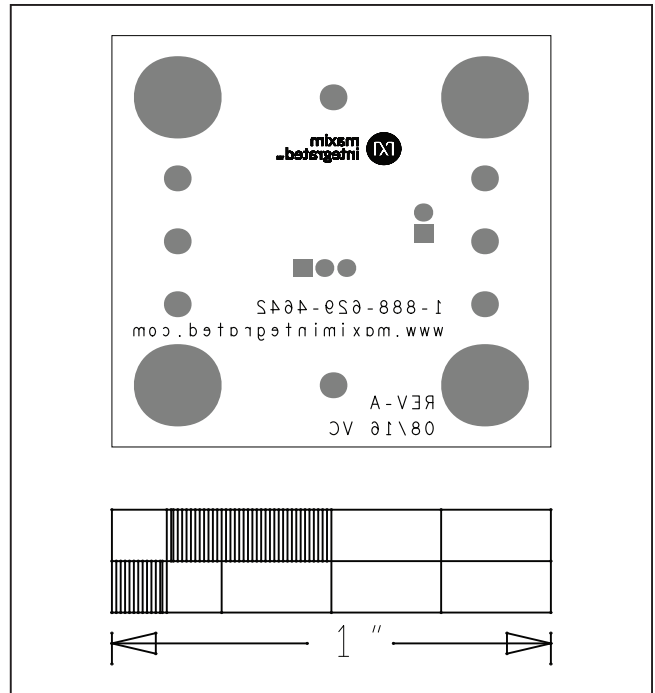

MAX40008 EV Kit—Bottom Silkscreen

# MAX40008/MAX40009 Evaluation Kit

Evaluates: MAX40008/MAX40009

## MAX40009 EV Kit Bill of Materials

ITEM	QTY	REF DES	VAR STATUS	MAXIMV	MFG PART #	MANUFACTURER	VALUE	DESCRIPTION	COMMENTS
1	2	C1, C2	Pref	20-000H1B19B	CL05B104K030ANN	SAMSUNG ELECTRONICS	0.1UF	CAPACITOR, SMT (0402), CERAMIC, 0.1µF, 18V, TOL = 10%; TG = -55°C TO +125°C; TC = X7R	
2	3	X1, X2, GND	Pref	02-TPMINI5001-00	5001	KEYSTONE	N/A	TEST POINT; PIN DIA = 0.1IN; TOTAL LENGTH = 0.3IN; BOARD HOLE = 0.04IN; BLACK; PHOSPHOR BRONZE WIRE SILVER PLATE FINISH; RECOMMENDED FOR BOARD THICKNESS = 0.082IN; NOT FOR COLD TEST	
3	3	INM, INF, VOUT	Pref	02-TPMINI5002-00	5002	KEYSTONE	N/A	TEST POINT; PIN DIA = 0.1IN; TOTAL LENGTH = 0.3IN; BOARD HOLE = 0.04IN; WHITE; PHOSPHOR BRONZE WIRE SILVER; NOT FOR COLD TEST	
4	1	J1	Pref	01-FTS10201LS2P-19	FTS-102-01-L-S	SAMTEC	FTS-102-01-L-S	CONNECTOR, MALE; THROUGH HOLE; 1.27MM MICRO LOW PROFILE TERMINAL STRIP; STRAIGHT; 2PINS; NOTE: SPECIAL ORDER ONLY. PURCHASING OF THIS PRODUCT IS CASE-TO-CASE BASIS.	
5	1	J2	Pref	01-FTS10301LS3P-21	FTS-103-01-L-S	SAMTEC	FTS-103-01-L-S	CONNECTOR, MALE; THROUGH HOLE; MICRO LOW PROFILE TERMINAL STRIP; STRAIGHT; 3PINS	
6	1	R1	Pref	80-000R-26A	ERJ2ZGER00X	PANASONIC	0	RESISTOR, 0402, 00, 0%, JUMPER, 0.10W, THICK FILM	
7	1	R3	Pref	80-003BK-23	ERJ2ZKF3002X	PANASONIC	39K	RESISTOR, 0402, 39KΩ, 1%, 100PPM, 0.0625W, THICK FILM	
8	2	SU1, SU2	Pref	02-IMP25NBKG-00	2SN-BK-G	SAMTEC	2SN-BK-G	TEST POINT, JUMPER STR; TOTAL LENGTH = 0.175IN; BLACK; INSULATION = PBT; PHOSPHOR BRONZE CONTACT-GOLD PLATED	
9	1	U1	Pref	MAX40009ANT+	MAX40009ANT+	MAXIM	MAX40009ANT+	EVAL KIT PART; IC; MAX40009ANT+; PACKAGE OUTLINE: 21-100866C;	
10	2	VDD, VPULL	Pref	02-TPMINI5000-00	5000	KEYSTONE	N/A	TEST POINT; PIN DIA = 0.1IN; TOTAL LENGTH = 0.3IN; BOARD HOLE = 0.04IN; RED; PHOSPHOR BRONZE WIRE SILVER PLATE FINISH; RECOMMENDED FOR BOARD THICKNESS = 0.082IN; NOT FOR COLD TEST	
11	1		Pref	EPCB40009	MAX40009	MAXIM	PCB	PCB: MAX40009	
TOTAL	18								
<b>DO NOT PURCHASE (DNP)</b>									
ITEM	QTY	REF DES	VAR STATUS	MAXIMV	MFG PART # <td>MANUFACTURER</td> <td>VALUE</td> <td>DESCRIPTION</td> <td>COMMENTS</td>	MANUFACTURER	VALUE	DESCRIPTION	COMMENTS
1	3	R2, RE, RB	DNP	80-000R-26A	ERJ2ZGER00X	PANASONIC	0	RESISTOR, 0402, 00, 0%, JUMPER, 0.10W, THICK FILM	
TOTAL	3								
<b>PACKOUT (These are purchased parts but not assembled on PCB and will be shipped with PCB)</b>									
ITEM	QTY	REF DES	MAXIMV	MFG PART #	MANUFACTURER	VALUE	DESCRIPTION	COMMENTS	
1	1	PACKOUT	88-00711-SML	88-00711-SML	N/A	?	BOX: SMALL BROWN 9 3/16X7X1 1/4 - PACKOUT		
2	1	PACKOUT	87-02162-00	87-02162-00	N/A	?	ESD BAG; BAG; STATIC SHIELD ZIP 4HX8PR; WESB LOGO - PACKOUT		
3	1	PACKOUT	85-MAXKIT-PNK	85-MAXKIT-PNK	N/A	?	PINK FOAM; FOAM; ANTI-STATIC PE 12in X 12in X 5MM - PACKOUT		
4	1	PACKOUT	EVSINERT	EVSINERT	N/A	?	WEB INSTRUCTIONS FOR MAXIM DATA SHEET		
5	1	PACKOUT	85-84003-006	85-84003-006	N/A	?	LABEL/LEV KIT BOX1 - PACKOUT		
TOTAL	5								

MAX40009 EV Kit Schematics

# MECHANICAL

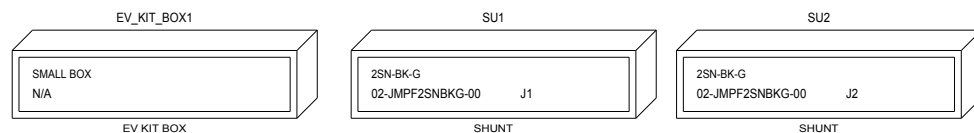

MAX40009 EV Kit Schematics (continued)

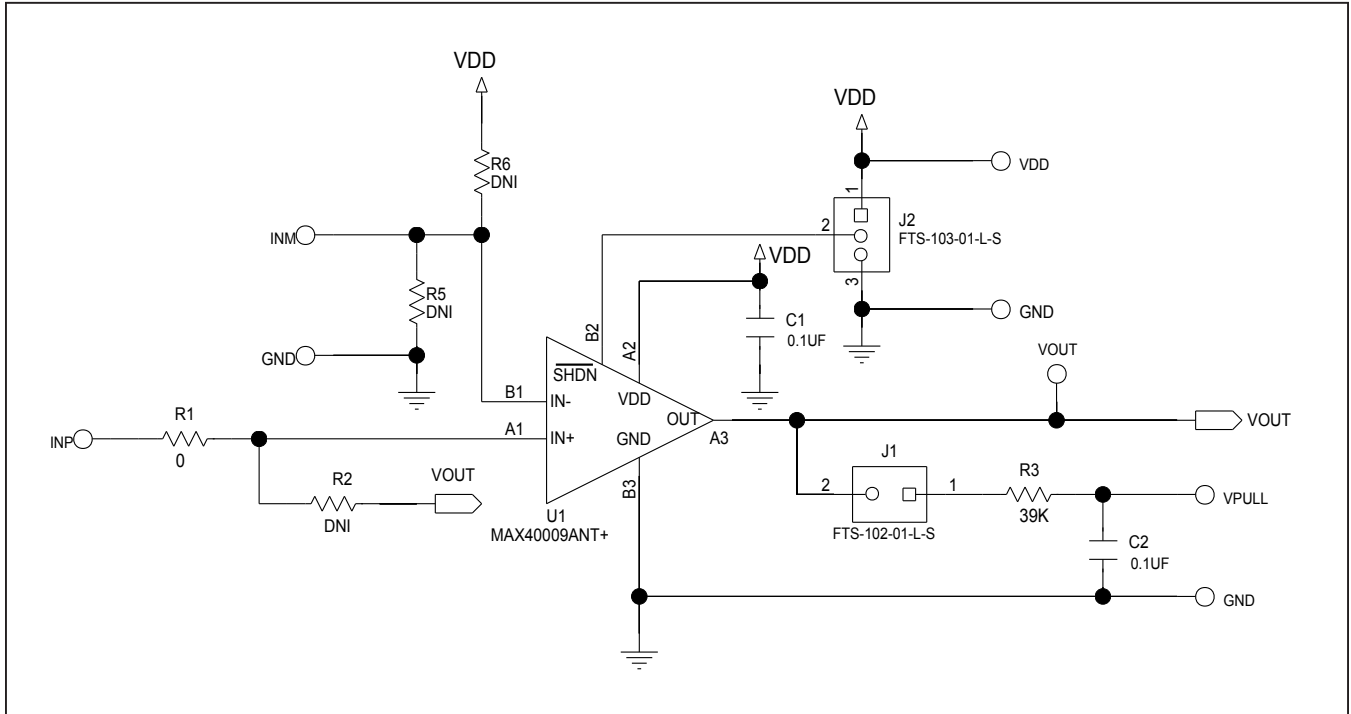



MAX40009 EV Kit PCB Layout Diagrams

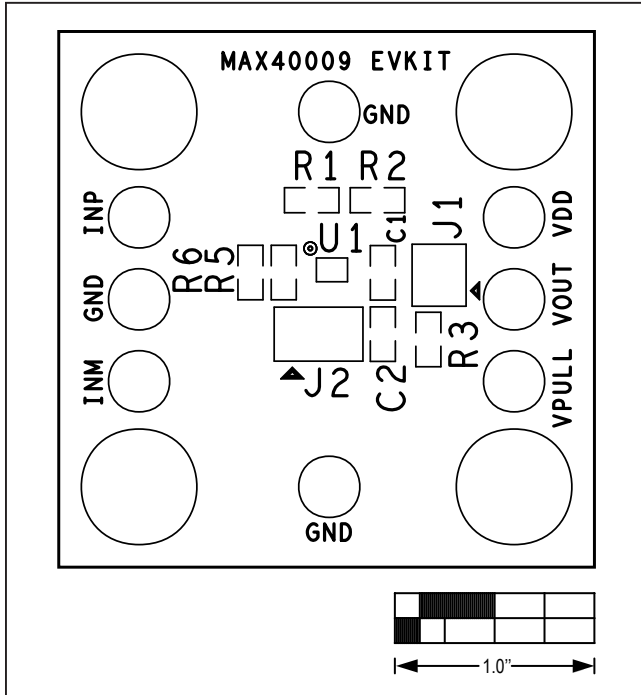

MAX40009 EV Kit—Top Silkscreen

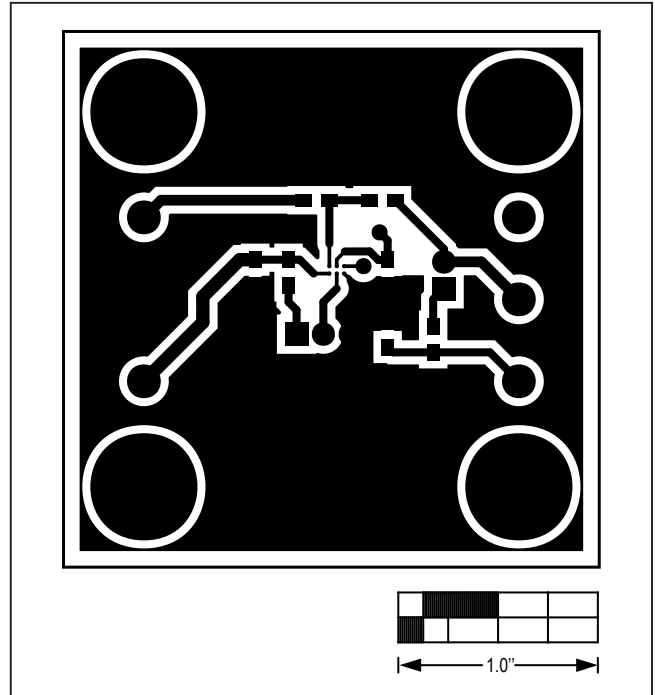

MAX40009 EV Kit—Top

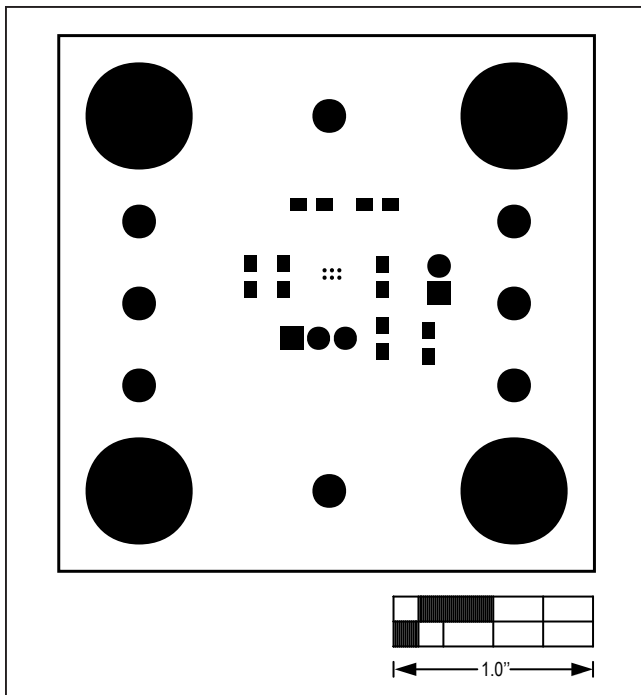

MAX40009 EV Kit—Top Mask

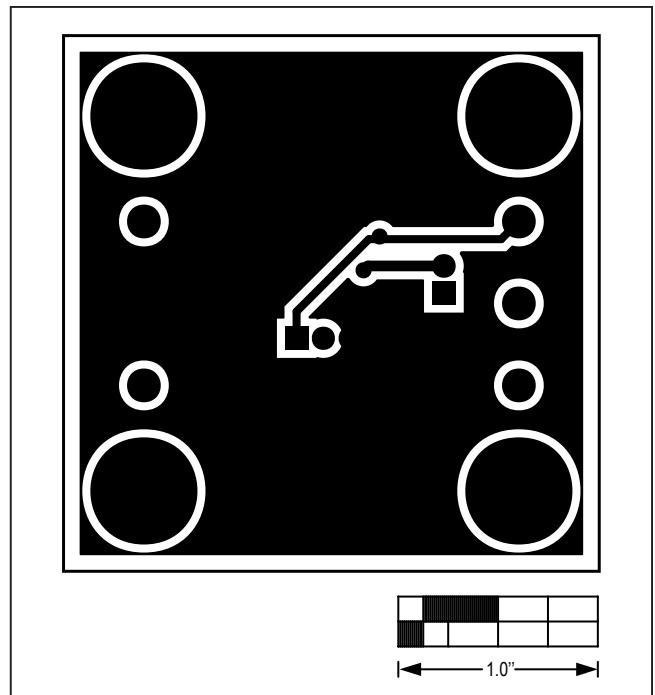

MAX40009 EV Kit—Bottom

MAX40009 EV Kit PCB Layout Diagrams (continued)

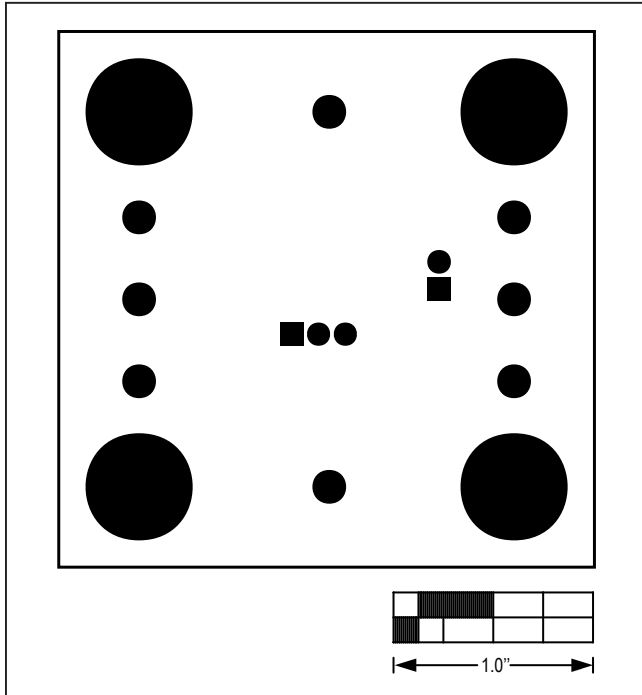

MAX40009 EV Kit—Bottom Mask

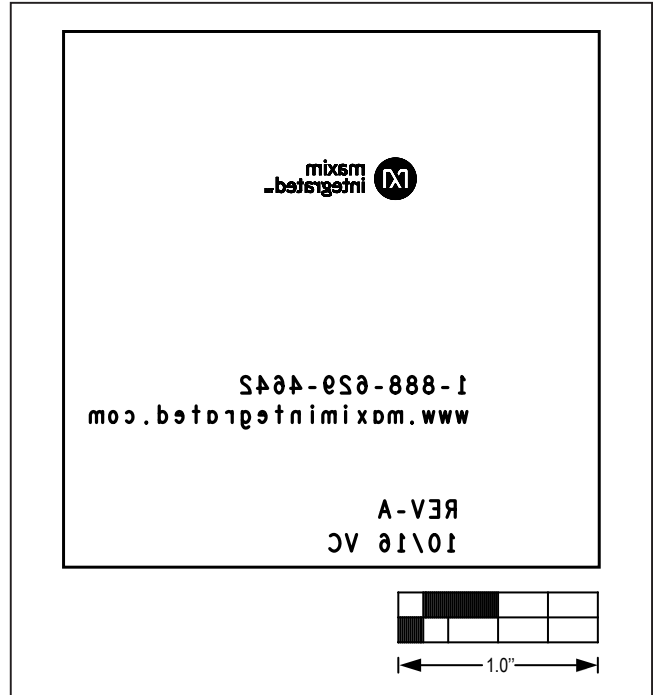

MAX40009 EV Kit—Bottom Silkscreen

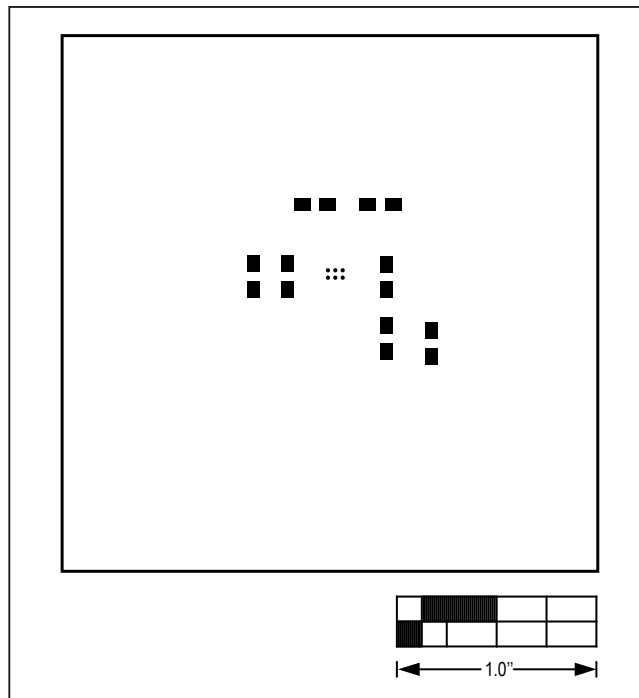

MAX40009 EV Kit—Top Paste

## Revision History

REVISION NUMBER	REVISION DATE	DESCRIPTION	PAGES CHANGED
0	3/17	Initial release	—
1	6/17	Added MAX40008 part number	1–11

For pricing, delivery, and ordering information, please contact Maxim Direct at 1-888-629-4642, or visit Maxim Integrated's website at [www.maximintegrated.com](http://www.maximintegrated.com).

*Maxim Integrated cannot assume responsibility for use of any circuitry other than circuitry entirely embodied in a Maxim Integrated product. No circuit patent licenses are implied. Maxim Integrated reserves the right to change the circuitry and specifications without notice at any time.*