

Series: ARMADILLO

Description: Vehicular Multiband Antenna with Magnetic Mount

PART NUMBER: ARMXXXXMM



Features:

- Low profile, only 1.8" tall
- Up to 6-lead Configuration
 - LTE(2x) MIMO
 - WiFi(3x) MIMO-|2.4/5.x GHz
 - GPS/GNSS (1x)
- Frequency of Operation:
 - 698-960MHz,1710-2690MHz
 - 2400-2500MHz,5150-5925MHz
 - 1559-1606MHz

Applications:

- Telematics, Navigation
- First Responders(Police, Fire, Ambulance/EMS)
- Energy, Utility, Construction
- Fleet Management
- DSRC(Dedicated Short Range Communications)
- Available Configurations:
 - Black, White
 - Magnetic mount
 - For direct mount seep/N: ARMXXXXDM

Issue: 1842

In the effort to improve our products, we reserve the right to make changes judged to be necessary.

CONFIDENTIAL AND PROPRIETARY INFORMATION

This document contains confidential and proprietary information of Pulse Electronics, Inc. (Pulse) and is protected by copyright, trade secret and other state and federal laws. Its receipt or possession does not convey any rights to reproduce, disclose its contents, or to manufacture, use or sell anything it may describe. Reproduction, disclosure or use without specific written authorization of Pulse is strictly forbidden.

For more information:

Pulse Worldwide Headquarters
15255 Innovation Drive #100
San Diego, CA 92128
USA
Tel:1-858-674-8100

Pulse/Larsen Antennas
18110 SE 34th St Bldg 2 Suite 250
Vancouver, WA 98683
USA
Tel: 1-360-944-7551

Europe Headquarters
Pulse GmbH & Do, KG
Zeppelinstrasse 15
Herrenberg, Germany
Tel: 49 7032 7806 0

Pulse (Suzhou) Wireless Products Co, Inc.
99 Huo Ju Road(#29 Bldg,4th Phase
Suzhou New District
Jiangsu Province, Suzhou 215009 PR China
Tel: 86 512 6807 9998



Description: Vehicular Multiband Antenna with Magnetic Mount

Series: ARMADILLO

PART NUMBER: ARMXXXXMM

This document covers all product variants of the following product family

Product	Total Cable Leads	LTE Cable Leads	WiFi Cable Leads	GPS Cable Leads	Housing Color	Mounting
ARM62311MM	6	2	3	1	Black	Magnetic Mount; Pull force: 100N, 22lbf min. (Tested on 3mm thick steel plate.)
ARM62312MM	6	2	3	1	White	
ARM52211MM	5	2	2	1	Black	
ARM52212MM	5	2	2	1	White	
ARM42111MM	4	2	1	1	Black	
ARM42112MM	4	2	1	1	White	

Product Numbering

Vehicular Multiband Antenna with Direct Mount

(Part Number)

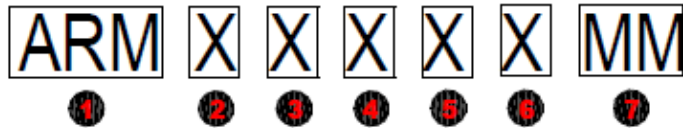

1	Product ID: ARMADILLO
2	Total Number of Cable leads
3	Total Number of LTE Cable Leads
4	Total Number of WiFi Cable Leads
5	Total Number of GPS Cable Leads
6	The Color of the Plastic Housing 1=Black; 2= White
7	Mounting: Magnetic Mount

ARMXXXXMM		CABLE	CABLE LENGTH	CONNECTOR
1	LTE-1 Cable Assy	LMR-195 *	5181 mm / 204" / 17 FT	SMA Male
2	WiFi-1 Cable Assy			RP-SMA Male
3	WiFi-3 Cable Assy			RP-SMA Male
4	WiFi-2 Cable Assy			RP-SMA Male
5	GPS Cable Assy	LMR-100 *		SMA Male
6	LTE-2 Cable Assy	LMR-195 *		SMA Male

* or equivalent

Issue: 1.0-2

In the effort to improve our products, we reserve the right to make changes judged to be necessary.

CONFIDENTIAL AND PROPRIETARY INFORMATION

This document contains confidential and proprietary information of Pulse Electronics, Inc. (Pulse) and is protected by copyright, trade secret and other state and federal laws. Its receipt or possession does not convey any rights to reproduce, disclose its contents, or to manufacture, use or sell anything it may describe. Reproduction, disclosure or use without specific written authorization of Pulse is strictly forbidden.

Description: Vehicular Multiband Antenna with Magnetic Mount

Series: ARMADILLO

PART NUMBER: ARMXXXXMM

ELECTRICAL SPECIFICATIONS

Frequency	698-960MHz, 1710-2690MHz 2400-2500MHz, 5150-5925MHz
Nominal Impedance	50 Ω
VSWR*	
698-960MHz	<2.5
1710-2690MHz	<2.5
2400-2500MHz	<2.5
5150-5925MHz	<2.5
Isolation*	
698-960MHz, 1710-2690MHz	-8dB
2400-2500MHz, 5150-5925MHz	-12dB
Radiation Pattern	Omni
Average Peak Gain**	
698-960MHz	4.6dBi
1710-2690MHz	5dBi
2400-2500MHz	4.1dBi
5150-5925MHz	6.3dBi
Polarization	Vertical

*Test on 500mm ground plane with 17ft(5.2m) LMR195 cable

**Test on 500mm ground plane with 1ft(304.8) LMR195 cable

Series: ARMADILLO

Description: Vehicular Multiband Antenna with
Magnetic Mount

PART NUMBER: ARMXXXXMM

ELECTRICAL SPECIFICATIONS

GPS Antenna	
Frequency	1561.098±2.046MHz/ 1575.42±1.023MHz/ 1602.5625±4MHz
Nominal Impedance	50 Ω
VSWR	<2
Gain (Radiating Element)	1 dBic±1 dB
Gain (LNA Gain)	30 dB± 2 dB
Polarization	RHCP
Out of Band Rejection	
698 MHz	>70 dB
960 MHz	>65 dB
1710 MHz	>60 dB
2170 MHz	>65 dB
2400 MHz	>65 dB
2700 MHz	>65 dB
Noise Figure	<2.4 dB
Operating Voltage	3.3 – 5 Vdc
Current Consumption	<15mA

Series: ARMADILLO

Description: Vehicular Multiband Antenna with Magnetic Mount

PART NUMBER: ARMXXXXMM

MECHANICAL SPECIFICATIONS

Overall Length	202.3mm X 88.5mm X 45mm
Weight	1.1 Kg
Antenna Color / Material	Black or White
Connector type	Refer to Page 2
Cable type	Refer to Page 2
Cable length	Refer to Page 2

ENVIRONMENTAL SPECIFICATIONS

Operating Temperature	-40 ~ +85° C
Storage Temperature	-40 ~ +85° C
Ingress Protection	IP67
RoHS Compliant	Yes

OTHER SPECIFICATIONS

Total cable assembly loss for 5.2m (17') LMR-195 @850MHz	2.1dB
Total cable assembly loss for 5.2m (17') LMR-100 @1575MHz	5.9dB
Total cable assembly loss for 5.2m (17') LMR-195 @1930MHz	3.2dB
Total cable assembly loss for 5.2m (17') LMR-195 @2450MHz	3.6dB
Total cable assembly loss for 5.2m (17') LMR-195 @2500MHz	3.7dB
Total cable assembly loss for 5.2m (17') LMR-195 @5350MHz	5.5dB

Series: ARMADILLO

Description: Vehicular Multiband Antenna with
Magnetic Mount

PART NUMBER: ARMXXXXMM

MECHANICAL DRAWING

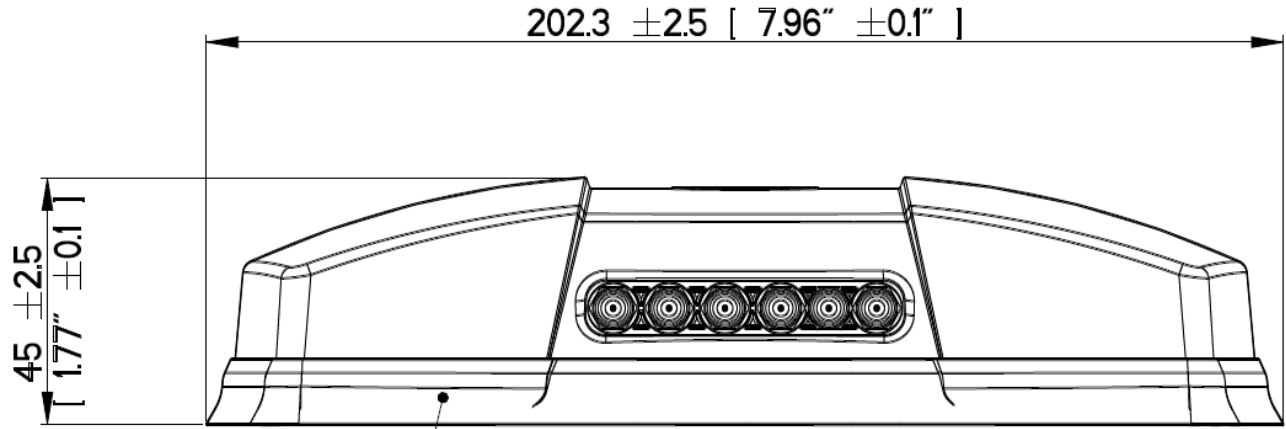

Rubber Gasket

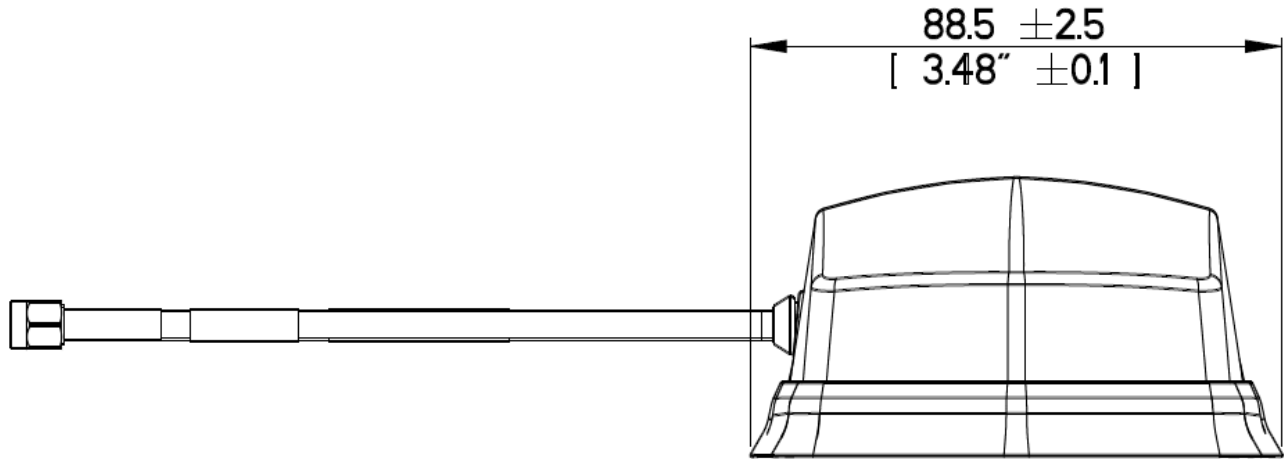

Issue: 1842

In the effort to improve our products, we reserve the right to make changes judged to be necessary.

CONFIDENTIAL AND PROPRIETARY INFORMATION

This document contains confidential and proprietary information of Pulse Electronics, Inc. (Pulse) and is protected by copyright, trade secret and other state and federal laws. Its receipt or possession does not convey any rights to reproduce, disclose its contents, or to manufacture, use or sell anything it may describe. Reproduction, disclosure or use without specific written authorization of Pulse is strictly forbidden.

Description: Vehicular Multiband Antenna with Magnetic Mount

Series: ARMADILLO

PART NUMBER: ARMXXXXXMM

MECHANICAL DRAWING

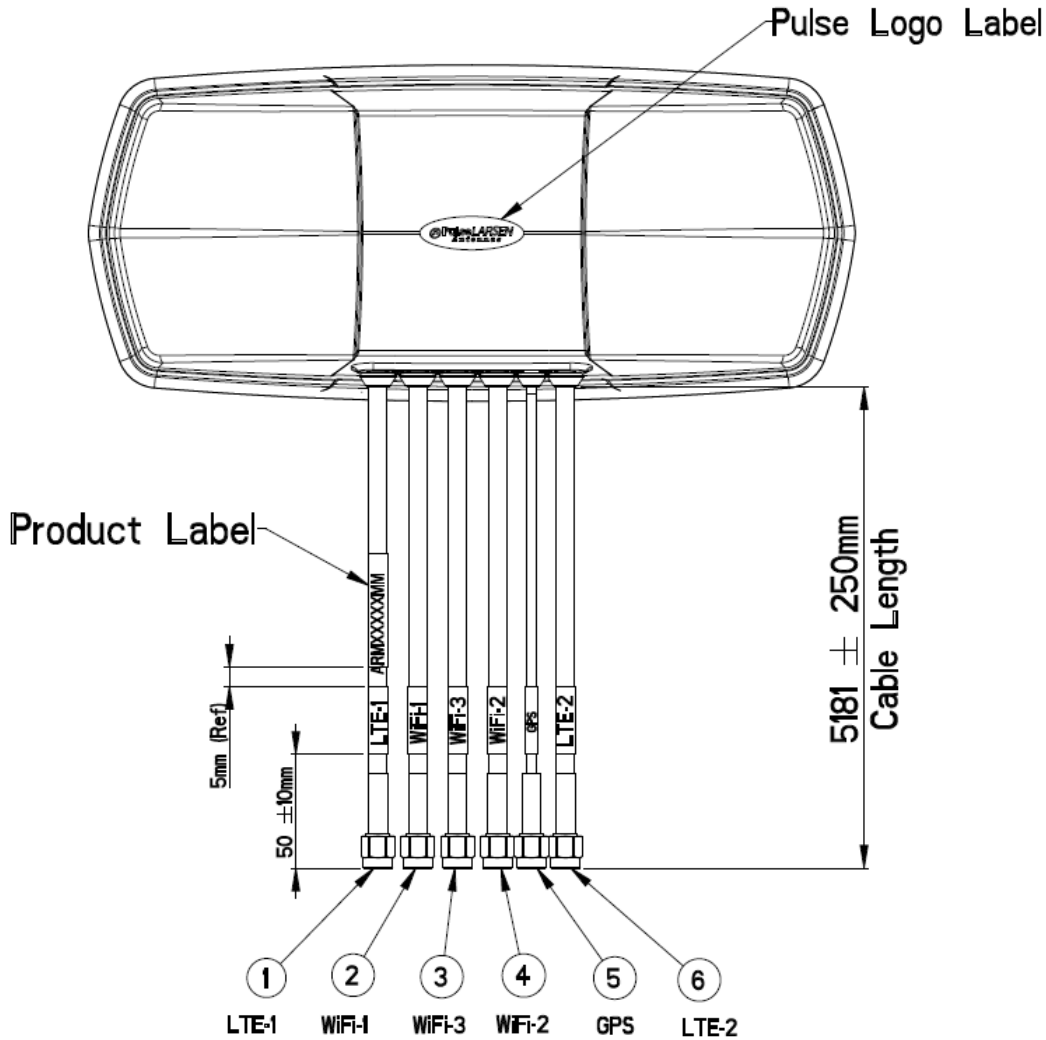

	ARMXXXXXMM	CABLE	CABLE LENGTH	CONNECTOR
1	LTE-1 Cable Assy	LMR-195 *	5181 mm / 204" / 17 FT	SMA Male
2	WiFi-1 Cable Assy			RP-SMA Male
3	WiFi-3 Cable Assy			RP-SMA Male
4	WiFi-2 Cable Assy			RP-SMA Male
5	GPS Cable Assy	LMR-100 *		SMA Male
6	LTE-2 Cable Assy	LMR-195 *		SMA Male

Issue: 1:

* or equivalent

In the effort to improve our products, we reserve the right to make changes judged to be necessary.

CONFIDENTIAL AND PROPRIETARY INFORMATION

This document contains confidential and proprietary information of Pulse Electronics, Inc. (Pulse) and is protected by copyright, trade secret and other state and federal laws. Its receipt or possession does not convey any rights to reproduce, disclose its contents, or to manufacture, use or sell anything it may describe. Reproduction, disclosure or use without specific written authorization of Pulse is strictly forbidden.

Series: ARMADILLO

Description: Vehicular Multiband Antenna with
Magnetic Mount

PART NUMBER: ARMXXXXXMM

TEST SETUP

Antenna tested on a $\Phi 500\text{mm}$ ground plane.

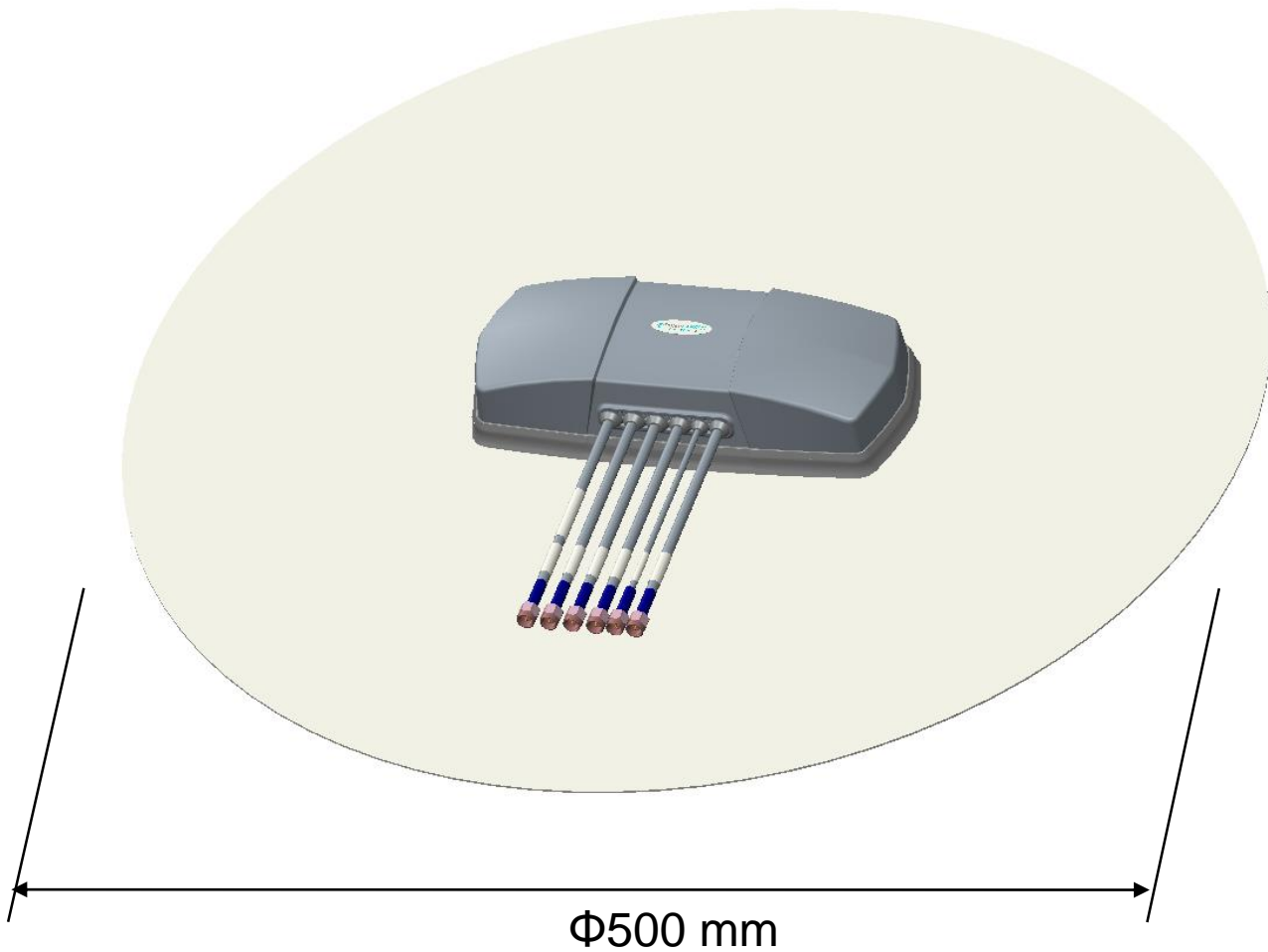

Description: Vehicular Multiband Antenna with Magnetic Mount

Series: ARMADILLO

PART NUMBER: ARMXXXXMM

CHARTS

VSWR (LTE)

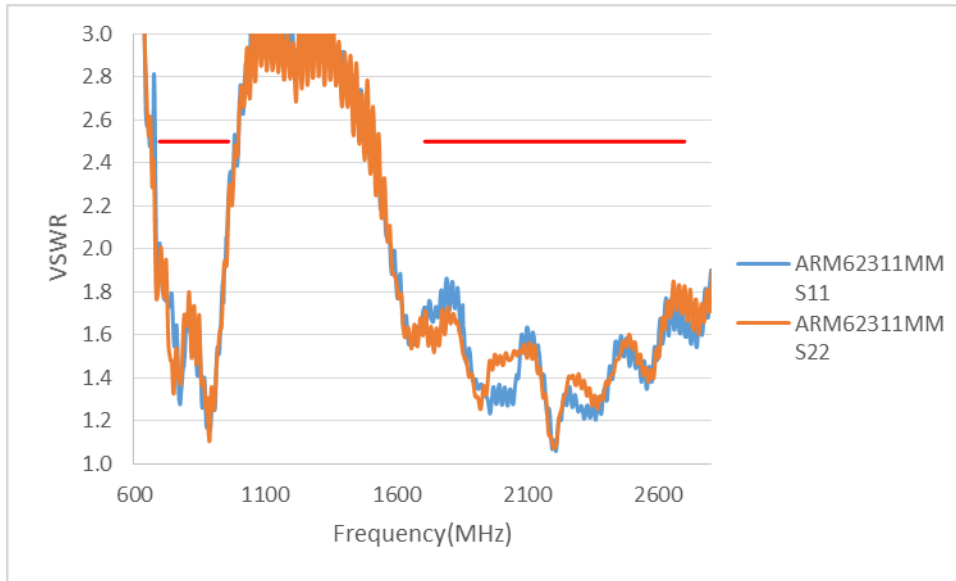

Isolation (LTE)

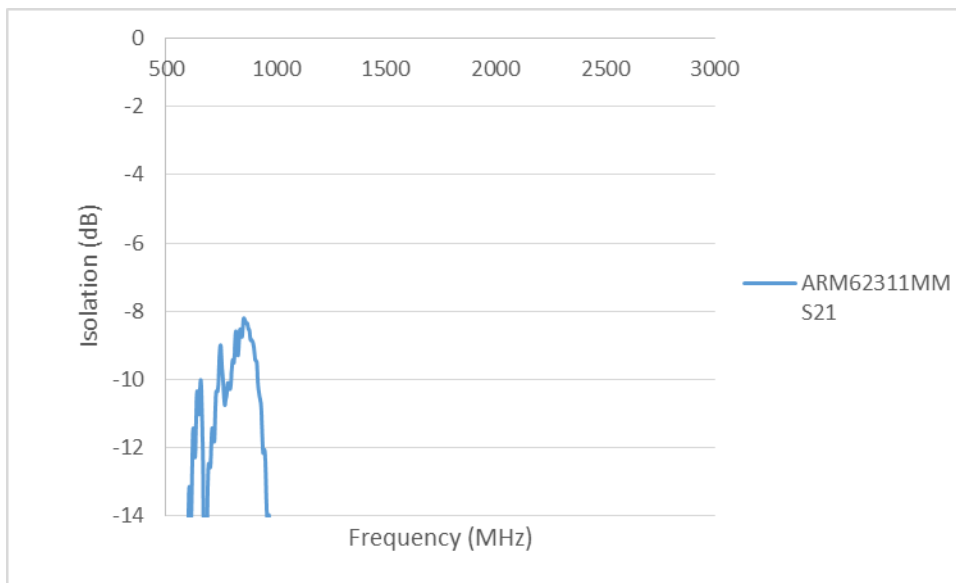

Note : Antenna tested with 5m cable on 500mm (dia) ground plane

Issue: 1842

In the effort to improve our products, we reserve the right to make changes judged to be necessary.

CONFIDENTIAL AND PROPRIETARY INFORMATION

This document contains confidential and proprietary information of Pulse Electronics, Inc. (Pulse) and is protected by copyright, trade secret and other state and federal laws. Its receipt or possession does not convey any rights to reproduce, disclose its contents, or to manufacture, use or sell anything it may describe. Reproduction, disclosure or use without specific written authorization of Pulse is strictly forbidden.

Description: Vehicular Multiband Antenna with Magnetic Mount

Series: ARMADILLO

PART NUMBER: ARMXXXXMM

CHARTS

Radiation Efficiency (LTE)

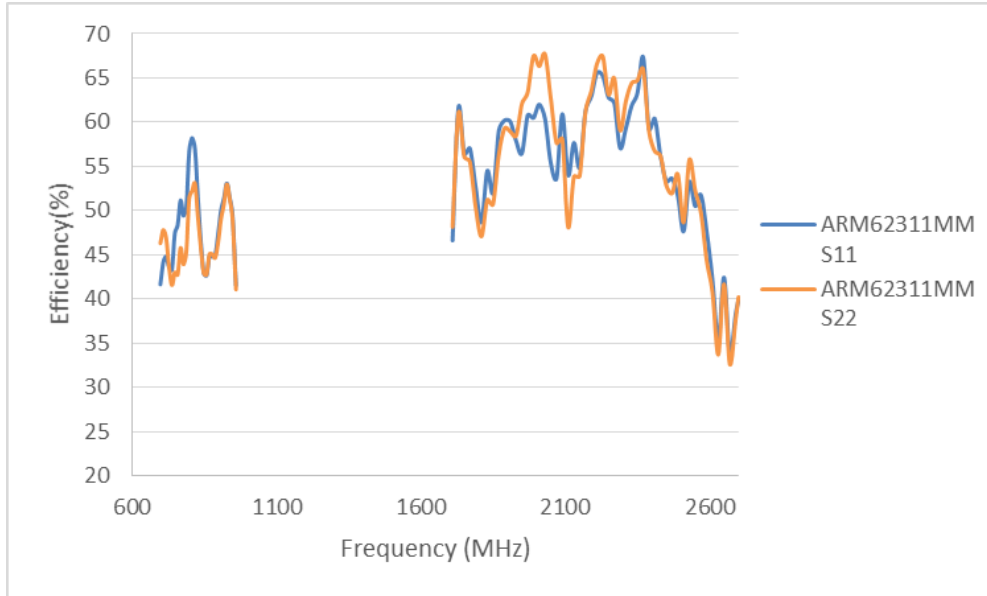

Peak Gain (LTE)

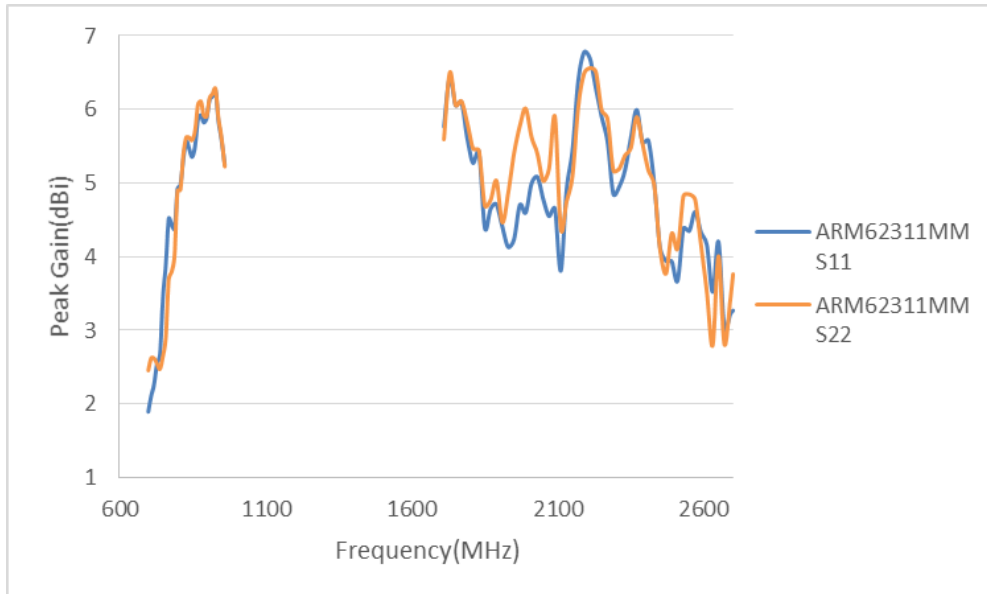

Note : Antenna tested with 1ft(304.8mm) cable on 500mm (dia) ground plane

Issue: 1842

In the effort to improve our products, we reserve the right to make changes judged to be necessary.

CONFIDENTIAL AND PROPRIETARY INFORMATION

This document contains confidential and proprietary information of Pulse Electronics, Inc. (Pulse) and is protected by copyright, trade secret and other state and federal laws. Its receipt or possession does not convey any rights to reproduce, disclose its contents, or to manufacture, use or sell anything it may describe. Reproduction, disclosure or use without specific written authorization of Pulse is strictly forbidden.

Series: ARMADILLO

Description: Vehicular Multiband Antenna with Magnetic Mount

PART NUMBER: ARMXXXXMM

CHARTS

VSWR (WIFI)

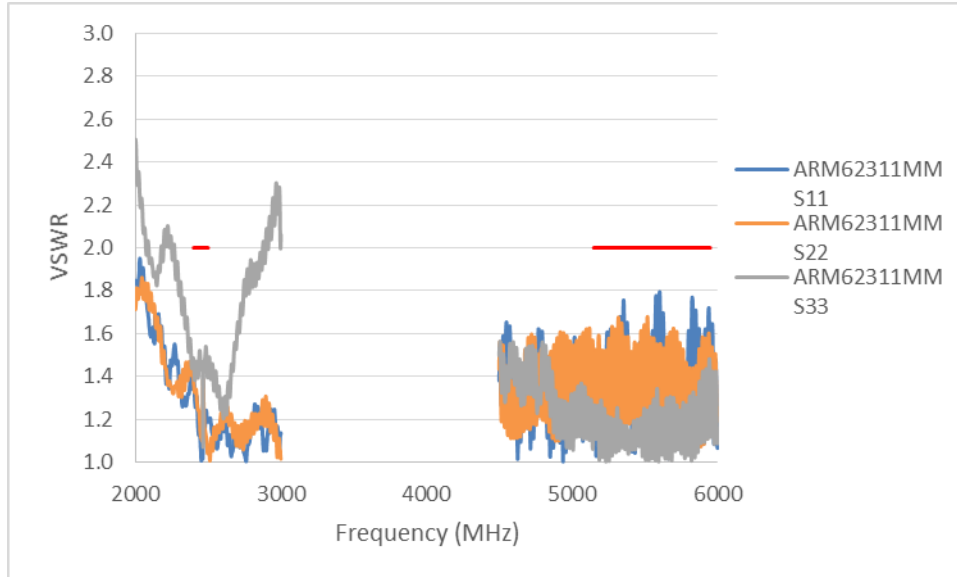

Isolation (WIFI)

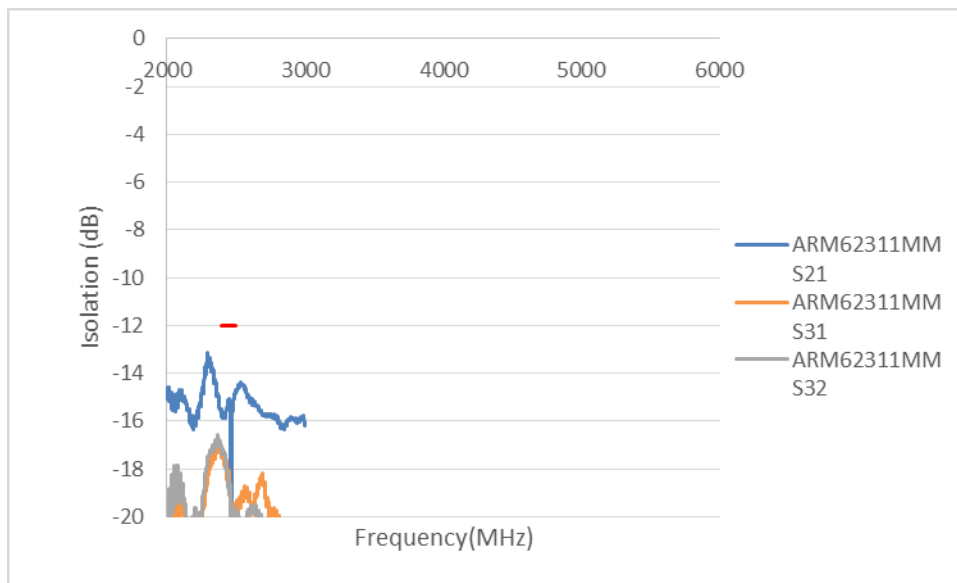

Note : Antenna tested with 5m cable on 500mm (dia) ground plane

Issue: 1842

In the effort to improve our products, we reserve the right to make changes judged to be necessary.

CONFIDENTIAL AND PROPRIETARY INFORMATION

This document contains confidential and proprietary information of Pulse Electronics, Inc. (Pulse) and is protected by copyright, trade secret and other state and federal laws. Its receipt or possession does not convey any rights to reproduce, disclose its contents, or to manufacture, use or sell anything it may describe. Reproduction, disclosure or use without specific written authorization of Pulse is strictly forbidden.

Description: Vehicular Multiband Antenna with Magnetic Mount

Series: ARMADILLO

PART NUMBER: ARMXXXXMM

CHARTS

Radiation Efficiency (WIFI)

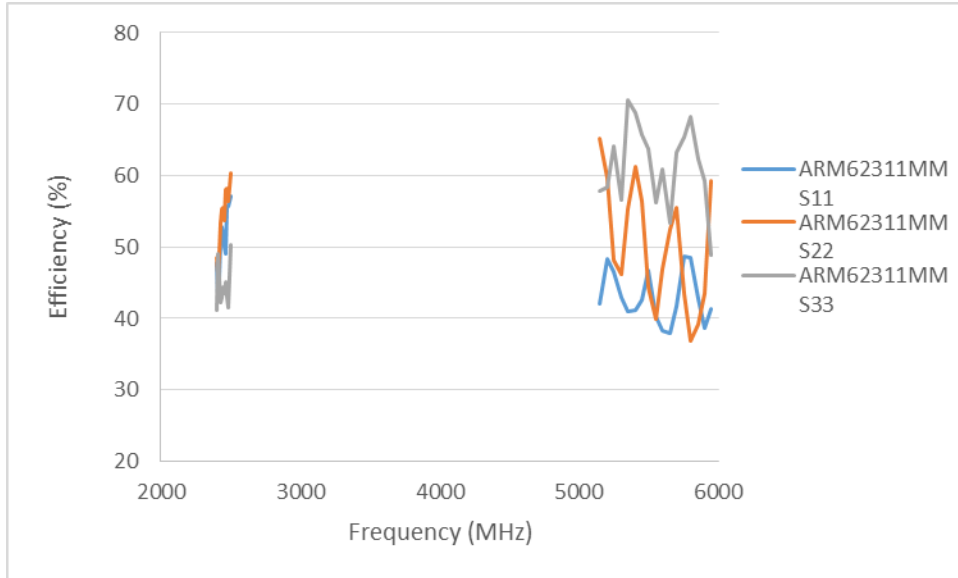

Peak Gain (WIFI)

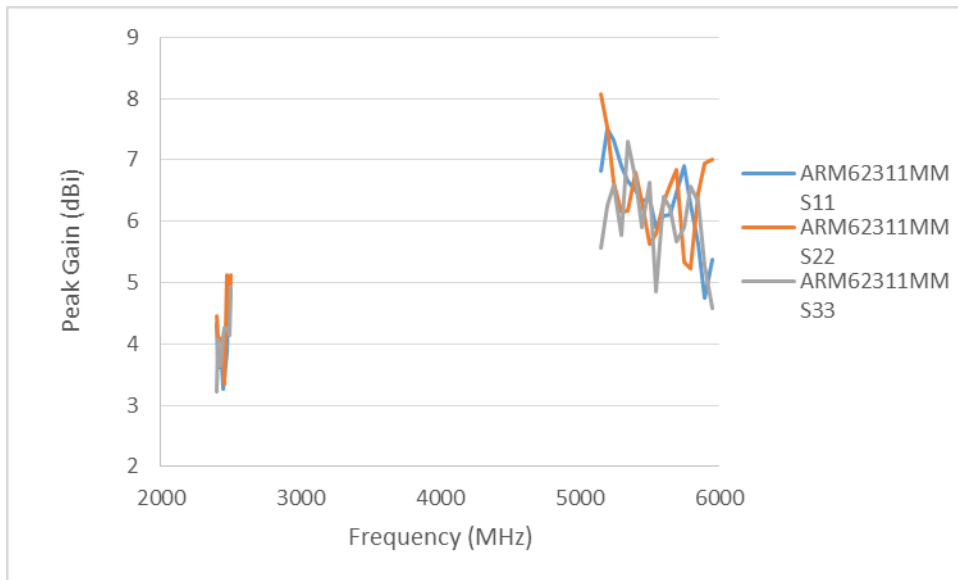

Note : Antenna tested with 1ft(304.8mm) cable on 500mm (dia) ground plane

Issue: 1842

In the effort to improve our products, we reserve the right to make changes judged to be necessary.

CONFIDENTIAL AND PROPRIETARY INFORMATION

This document contains confidential and proprietary information of Pulse Electronics, Inc. (Pulse) and is protected by copyright, trade secret and other state and federal laws. Its receipt or possession does not convey any rights to reproduce, disclose its contents, or to manufacture, use or sell anything it may describe. Reproduction, disclosure or use without specific written authorization of Pulse is strictly forbidden.

Description: Vehicular Multiband Antenna with Magnetic Mount

Series: ARMADILLO

PART NUMBER: ARMXXXXMM

CHARTS

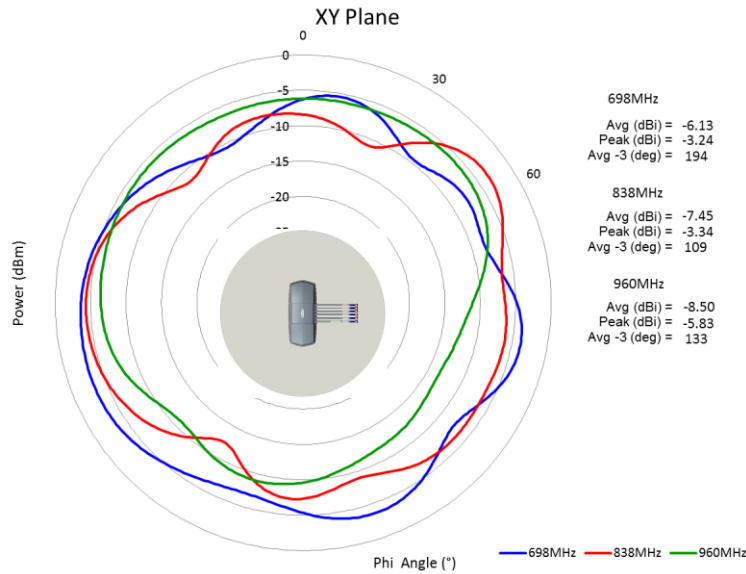

LTE1 XY plane radiation pattern

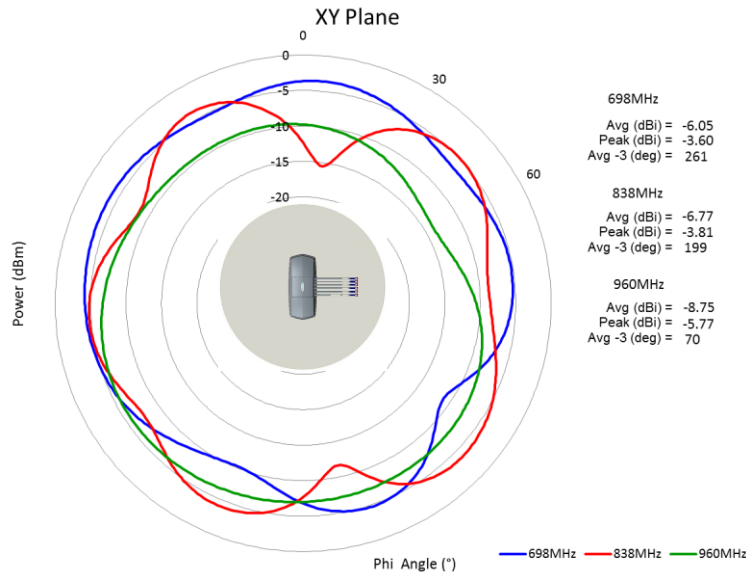

LTE2 XY plane radiation pattern

Issue: 1842

In the effort to improve our products, we reserve the right to make changes judged to be necessary.

CONFIDENTIAL AND PROPRIETARY INFORMATION

This document contains confidential and proprietary information of Pulse Electronics, Inc. (Pulse) and is protected by copyright, trade secret and other state and federal laws. Its receipt or possession does not convey any rights to reproduce, disclose its contents, or to manufacture, use or sell anything it may describe. Reproduction, disclosure or use without specific written authorization of Pulse is strictly forbidden.

Description: Vehicular Multiband Antenna with Magnetic Mount

Series: ARMADILLO

PART NUMBER: ARMXXXXMM

CHARTS

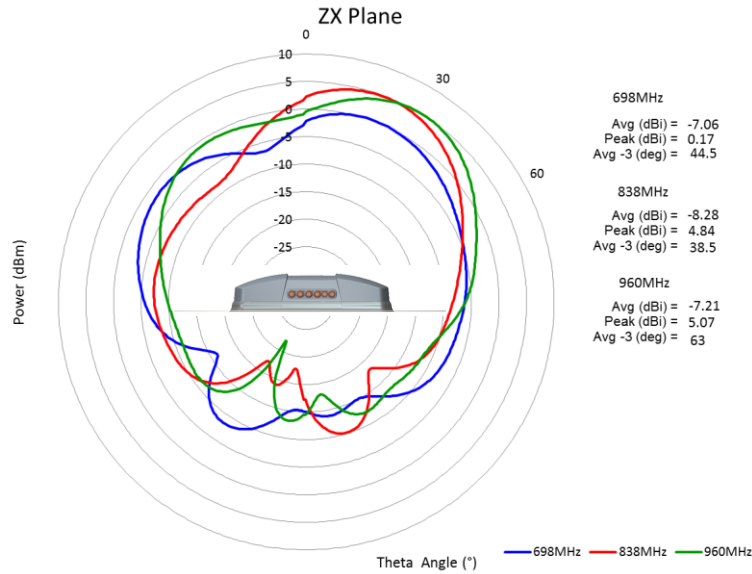

LTE1 ZX plane radiation pattern

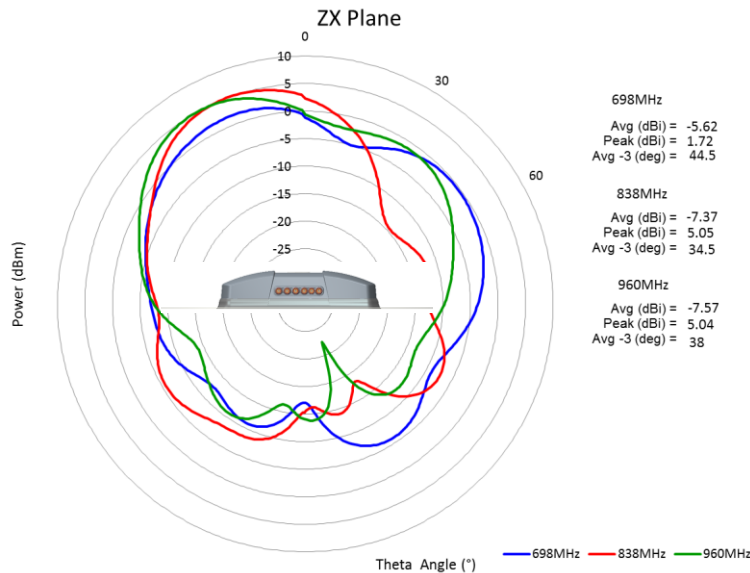

LTE2 ZX plane radiation pattern

Issue: 1842

In the effort to improve our products, we reserve the right to make changes judged to be necessary.

CONFIDENTIAL AND PROPRIETARY INFORMATION

This document contains confidential and proprietary information of Pulse Electronics, Inc. (Pulse) and is protected by copyright, trade secret and other state and federal laws. Its receipt or possession does not convey any rights to reproduce, disclose its contents, or to manufacture, use or sell anything it may describe. Reproduction, disclosure or use without specific written authorization of Pulse is strictly forbidden.

Series: ARMADILLO

Description: Vehicular Multiband Antenna with Magnetic Mount

PART NUMBER: ARMXXXXMM

CHARTS

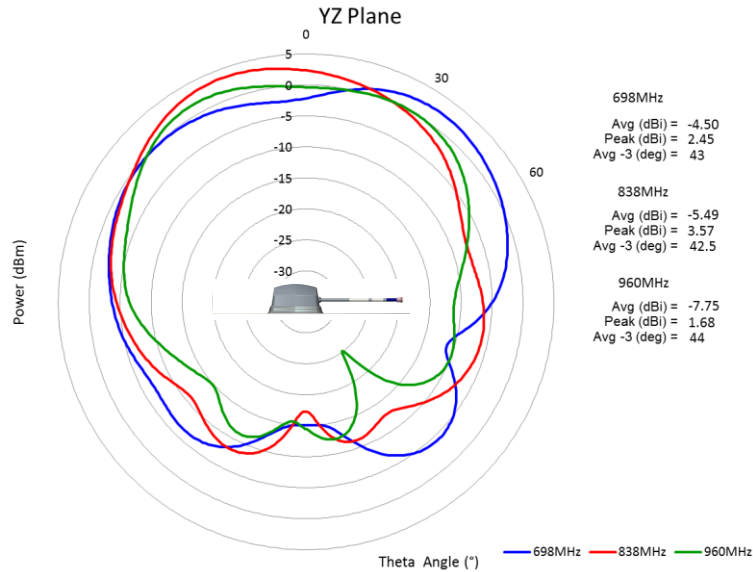

LTE1 YZ plane radiation pattern

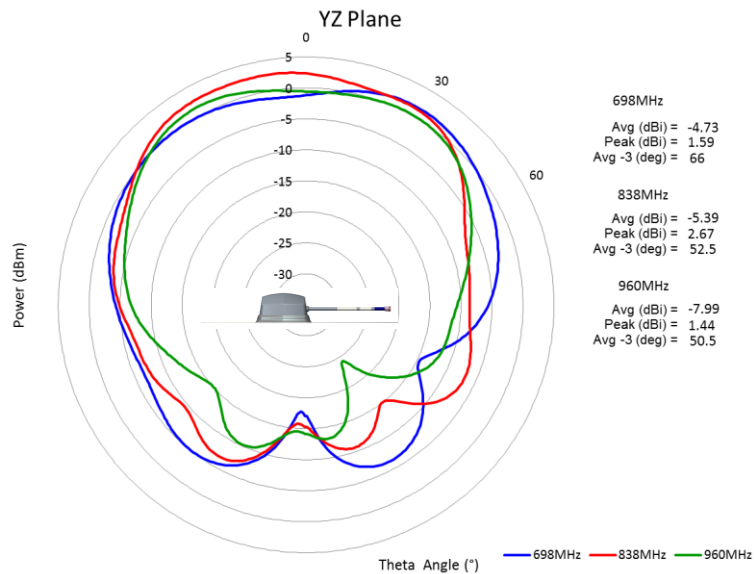

LTE2 YZ plane radiation pattern

Issue: 1842

In the effort to improve our products, we reserve the right to make changes judged to be necessary.

CONFIDENTIAL AND PROPRIETARY INFORMATION

This document contains confidential and proprietary information of Pulse Electronics, Inc. (Pulse) and is protected by copyright, trade secret and other state and federal laws. Its receipt or possession does not convey any rights to reproduce, disclose its contents, or to manufacture, use or sell anything it may describe. Reproduction, disclosure or use without specific written authorization of Pulse is strictly forbidden.

Description: Vehicular Multiband Antenna with Magnetic Mount

Series: ARMADILLO

PART NUMBER: ARMXXXXMM

CHARTS

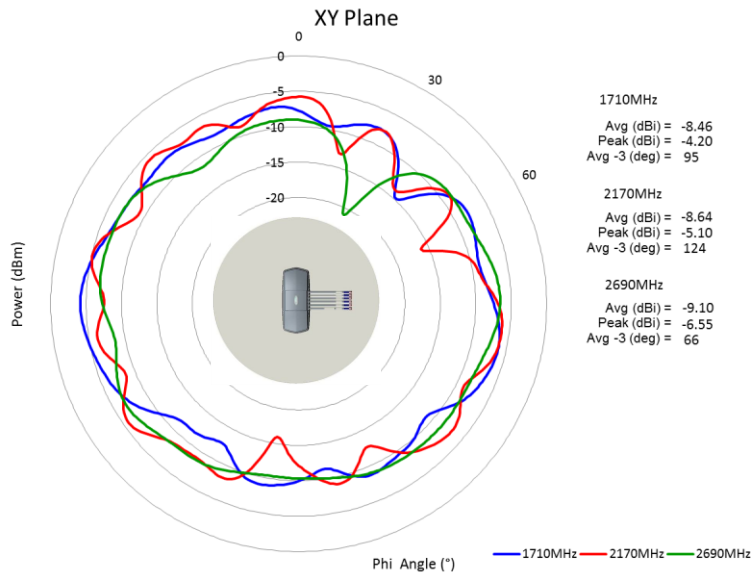

LTE1 XY plane radiation pattern

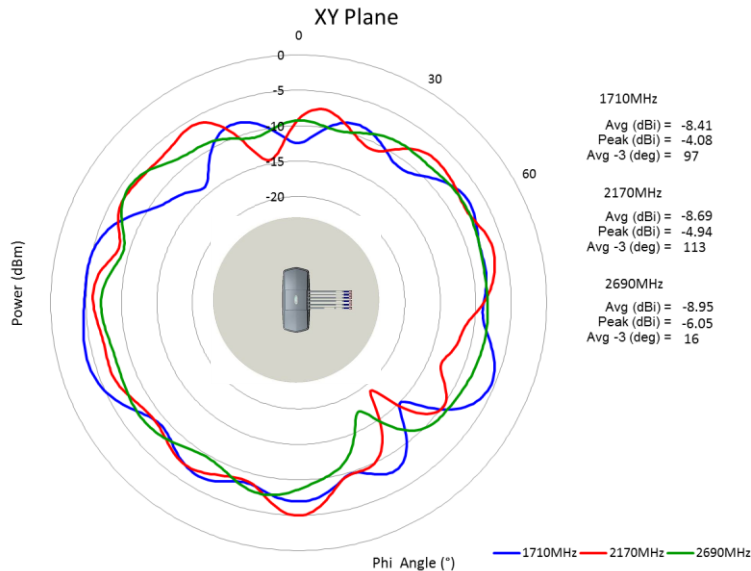

LTE2 XY plane radiation pattern

Issue: 1842

In the effort to improve our products, we reserve the right to make changes judged to be necessary.

CONFIDENTIAL AND PROPRIETARY INFORMATION

This document contains confidential and proprietary information of Pulse Electronics, Inc. (Pulse) and is protected by copyright, trade secret and other state and federal laws. Its receipt or possession does not convey any rights to reproduce, disclose its contents, or to manufacture, use or sell anything it may describe. Reproduction, disclosure or use without specific written authorization of Pulse is strictly forbidden.

Description: Vehicular Multiband Antenna with Magnetic Mount

Series: ARMADILLO

PART NUMBER: ARMXXXXMM

CHARTS

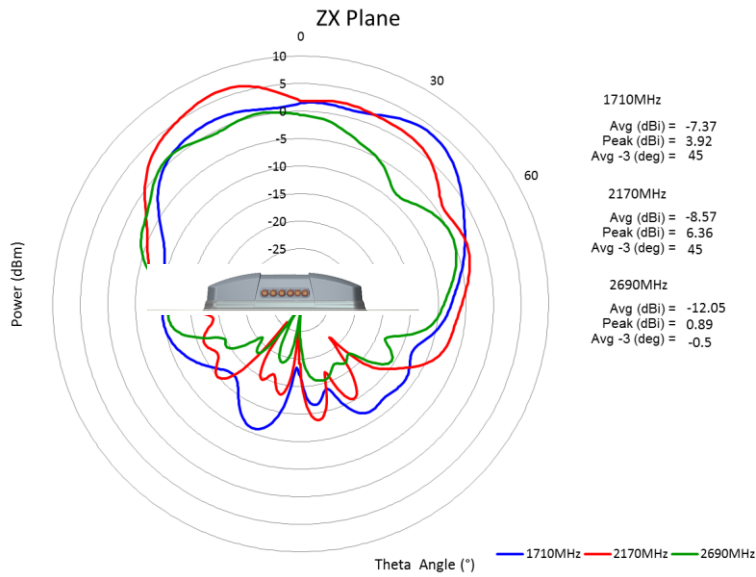

LTE1 ZX plane radiation pattern

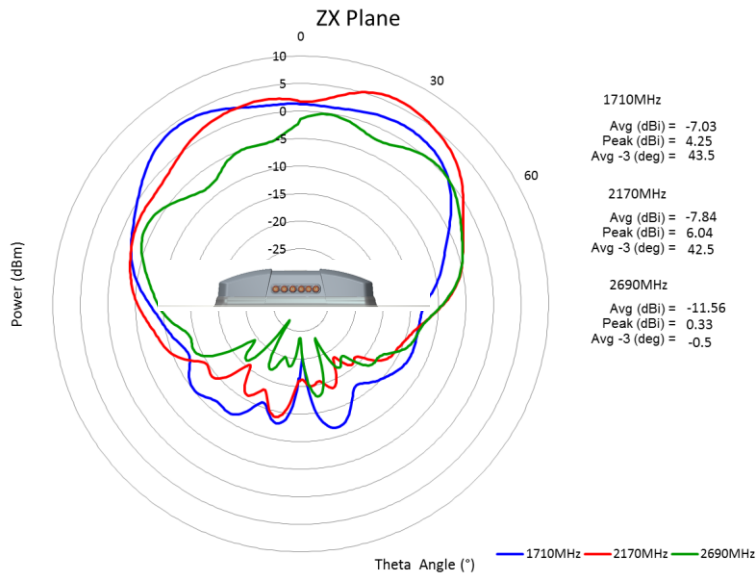

LTE2 ZX plane radiation pattern

Issue: 1842

In the effort to improve our products, we reserve the right to make changes judged to be necessary.

CONFIDENTIAL AND PROPRIETARY INFORMATION

This document contains confidential and proprietary information of Pulse Electronics, Inc. (Pulse) and is protected by copyright, trade secret and other state and federal laws. Its receipt or possession does not convey any rights to reproduce, disclose its contents, or to manufacture, use or sell anything it may describe. Reproduction, disclosure or use without specific written authorization of Pulse is strictly forbidden.

Description: Vehicular Multiband Antenna with Magnetic Mount

Series: ARMADILLO

PART NUMBER: ARMXXXXMM

CHARTS

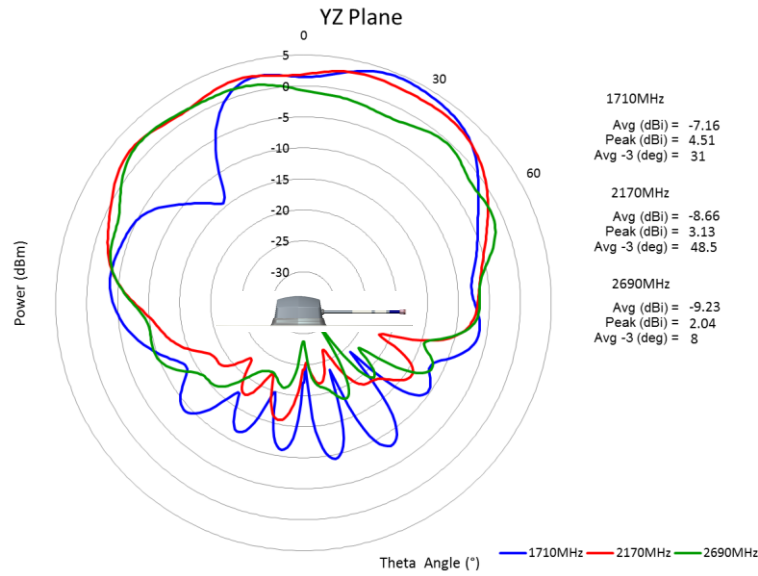

LTE1 YZ plane radiation pattern

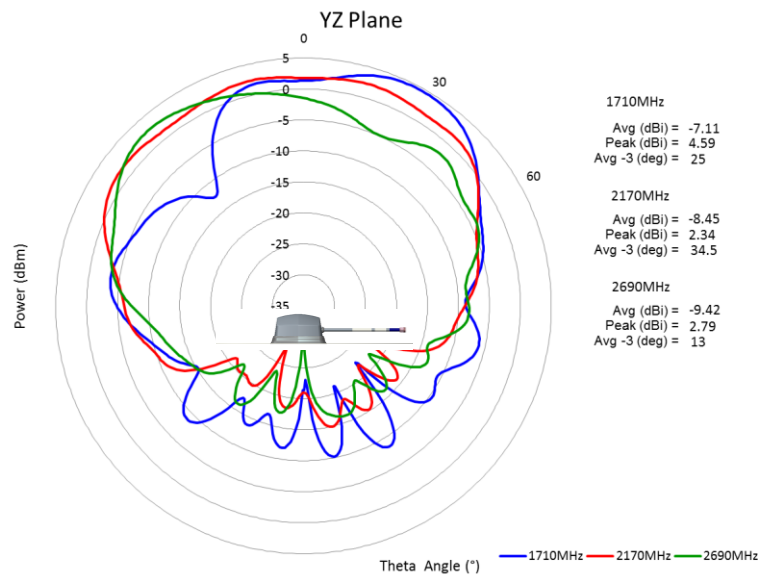

LTE2 YZ plane radiation pattern

Issue: 1842

In the effort to improve our products, we reserve the right to make changes judged to be necessary.

CONFIDENTIAL AND PROPRIETARY INFORMATION

This document contains confidential and proprietary information of Pulse Electronics, Inc. (Pulse) and is protected by copyright, trade secret and other state and federal laws. Its receipt or possession does not convey any rights to reproduce, disclose its contents, or to manufacture, use or sell anything it may describe. Reproduction, disclosure or use without specific written authorization of Pulse is strictly forbidden.

Description: Vehicular Multiband Antenna with Magnetic Mount

Series: ARMADILLO

PART NUMBER: ARMXXXXMM

CHARTS

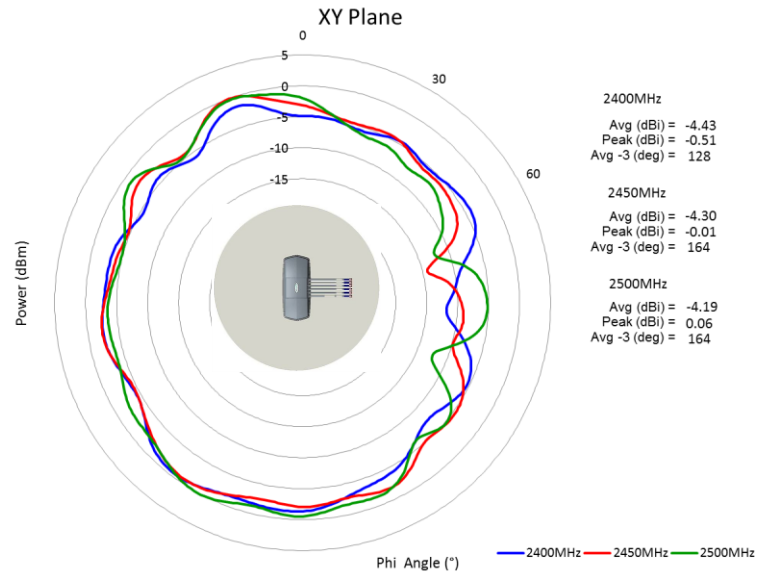
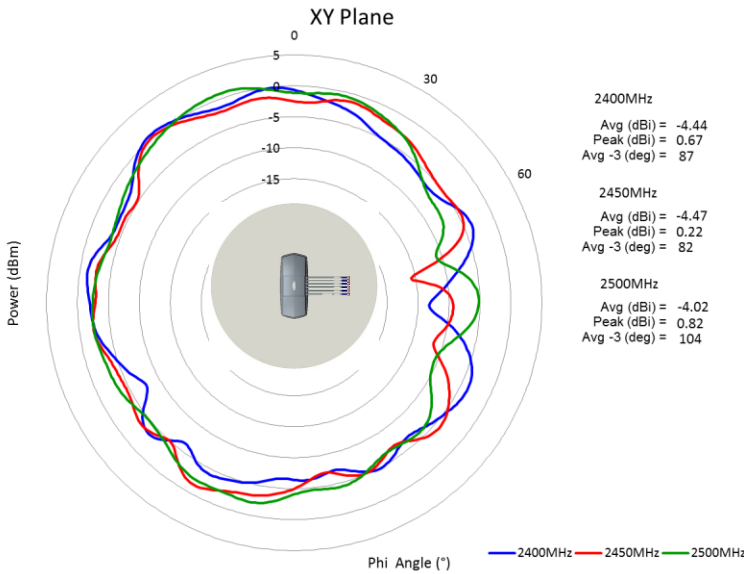

WiFi1 XY plane radiation pattern

WiFi2 XY plane radiation pattern

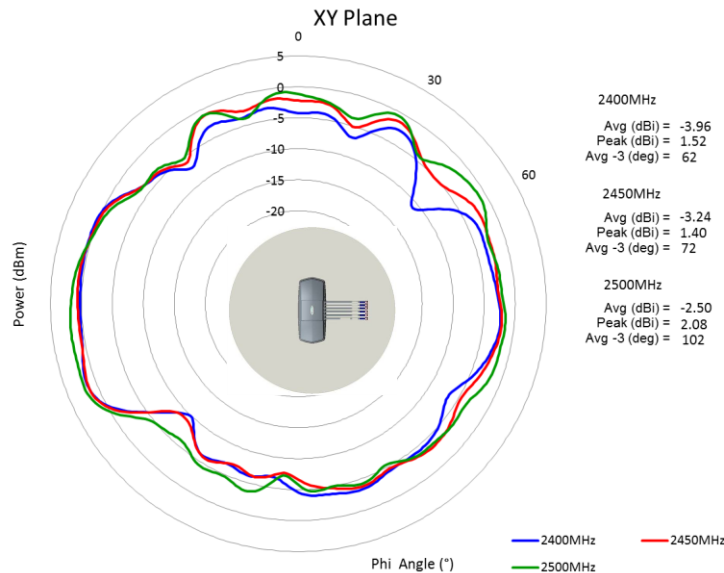

WiFi3 XY plane radiation pattern

Issue: 1842

In the effort to improve our products, we reserve the right to make changes judged to be necessary.

CONFIDENTIAL AND PROPRIETARY INFORMATION

This document contains confidential and proprietary information of Pulse Electronics, Inc. (Pulse) and is protected by copyright, trade secret and other state and federal laws. Its receipt or possession does not convey any rights to reproduce, disclose its contents, or to manufacture, use or sell anything it may describe. Reproduction, disclosure or use without specific written authorization of Pulse is strictly forbidden.

Description: Vehicular Multiband Antenna with Magnetic Mount

Series: ARMADILLO

PART NUMBER: ARMXXXXMM

CHARTS

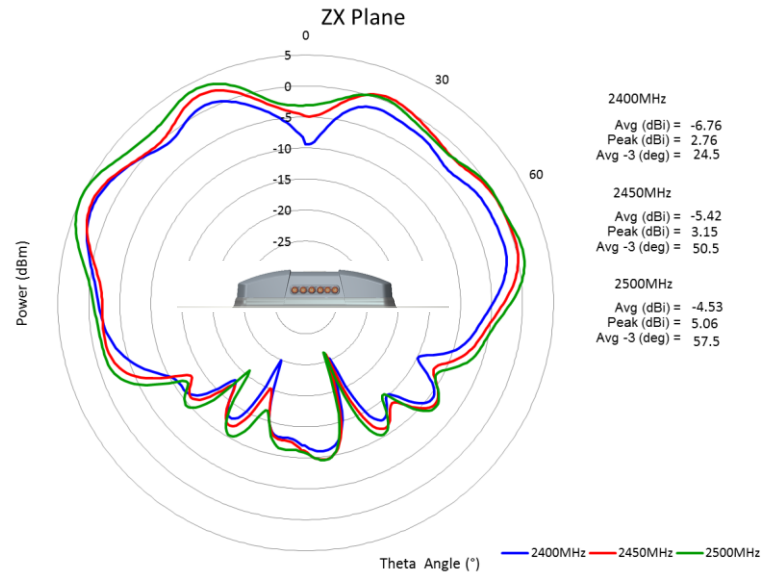
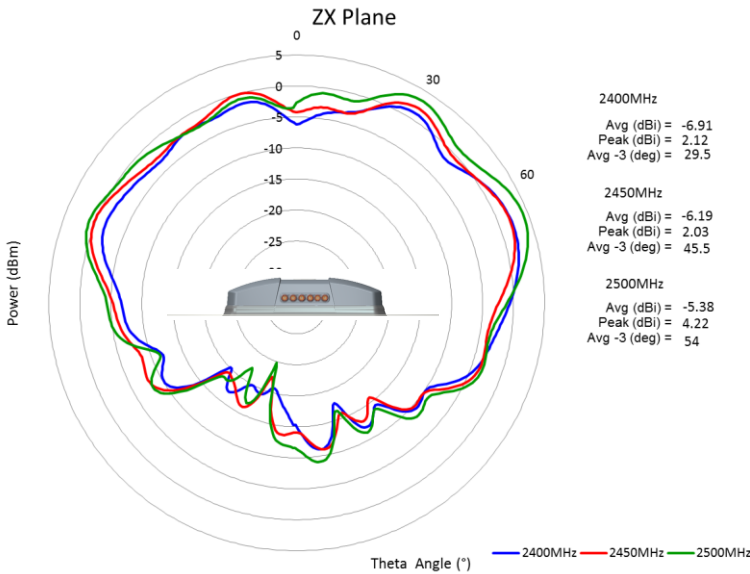

WiFi1 ZX plane radiation pattern

WiFi2 ZX plane radiation pattern

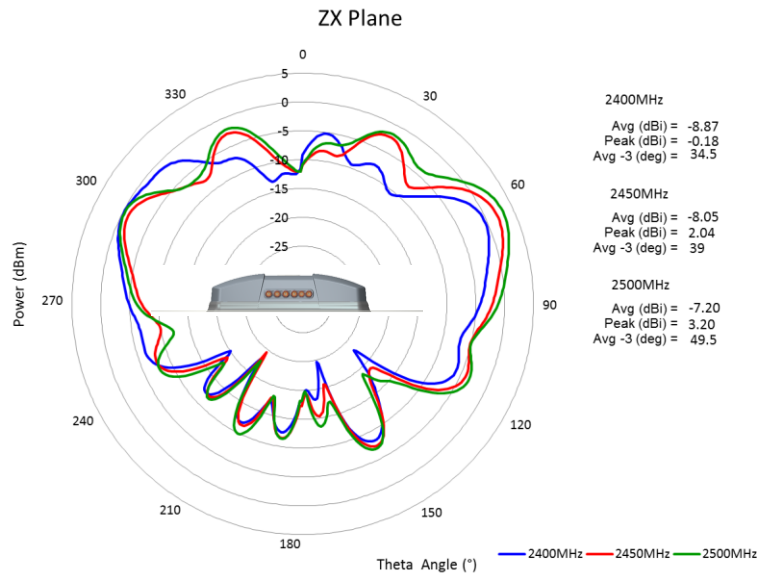

WiFi3 ZX plane radiation pattern

Issue: 1842

In the effort to improve our products, we reserve the right to make changes judged to be necessary.

CONFIDENTIAL AND PROPRIETARY INFORMATION

This document contains confidential and proprietary information of Pulse Electronics, Inc. (Pulse) and is protected by copyright, trade secret and other state and federal laws. Its receipt or possession does not convey any rights to reproduce, disclose its contents, or to manufacture, use or sell anything it may describe. Reproduction, disclosure or use without specific written authorization of Pulse is strictly forbidden.

Description: Vehicular Multiband Antenna with Magnetic Mount

Series: ARMADILLO

PART NUMBER: ARMXXXXMM

CHARTS

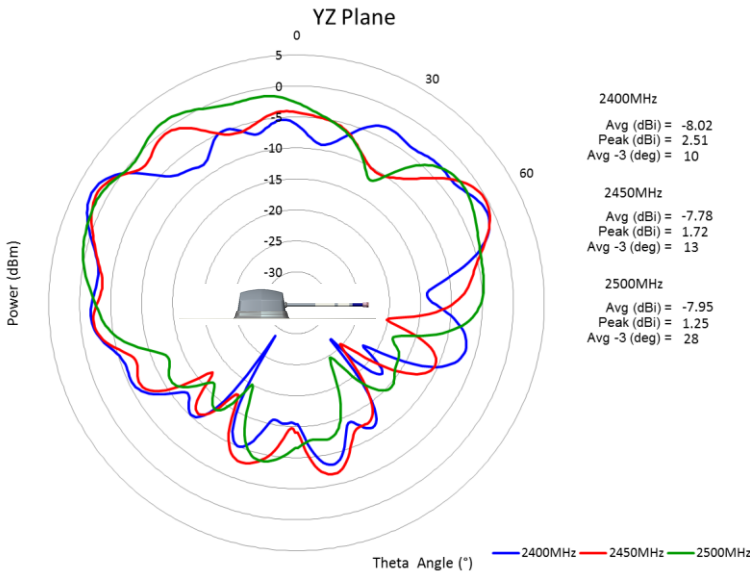

WiFi1 YZ plane radiation pattern

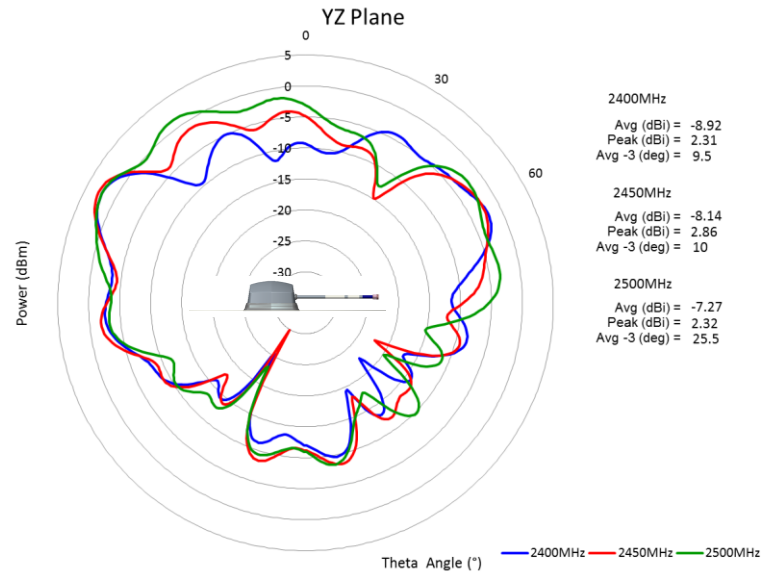

WiFi2 YZ plane radiation pattern

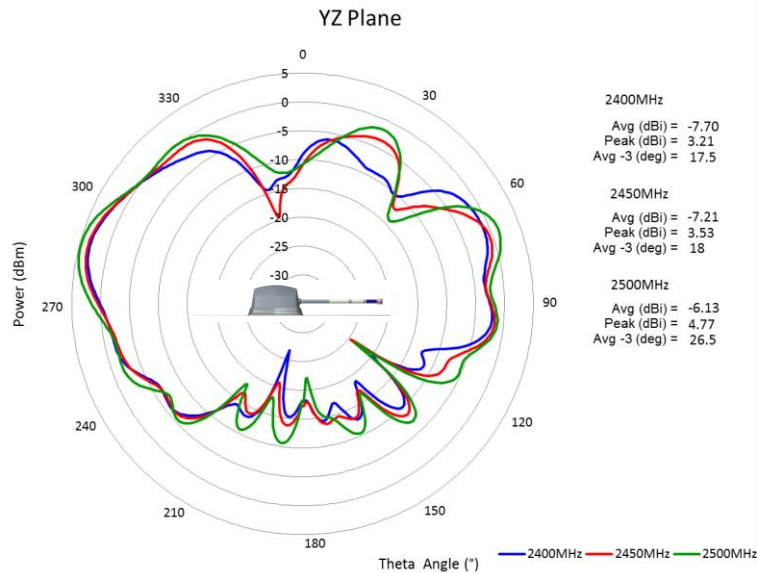

WiFi3 YZ plane radiation pattern

Issue: 1842

In the effort to improve our products, we reserve the right to make changes judged to be necessary.

CONFIDENTIAL AND PROPRIETARY INFORMATION

This document contains confidential and proprietary information of Pulse Electronics, Inc. (Pulse) and is protected by copyright, trade secret and other state and federal laws. Its receipt or possession does not convey any rights to reproduce, disclose its contents, or to manufacture, use or sell anything it may describe. Reproduction, disclosure or use without specific written authorization of Pulse is strictly forbidden.

Description: Vehicular Multiband Antenna with Magnetic Mount

Series: ARMADILLO

PART NUMBER: ARMXXXXMM

CHARTS

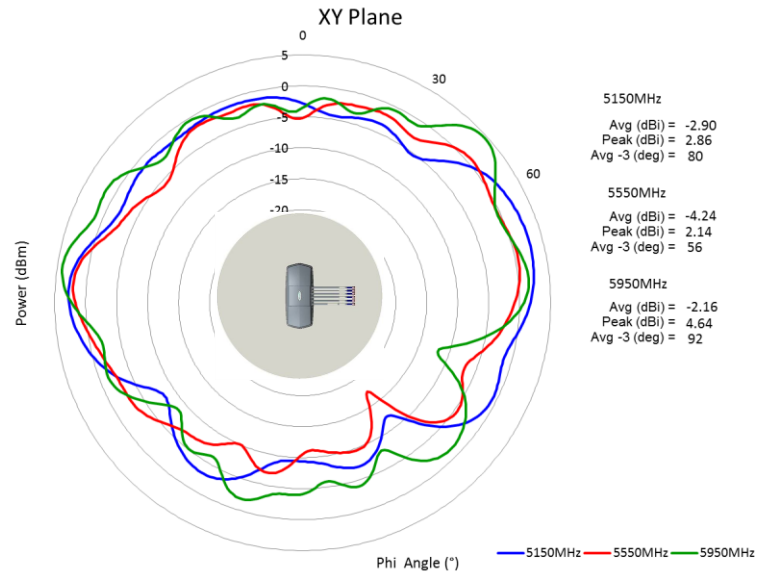
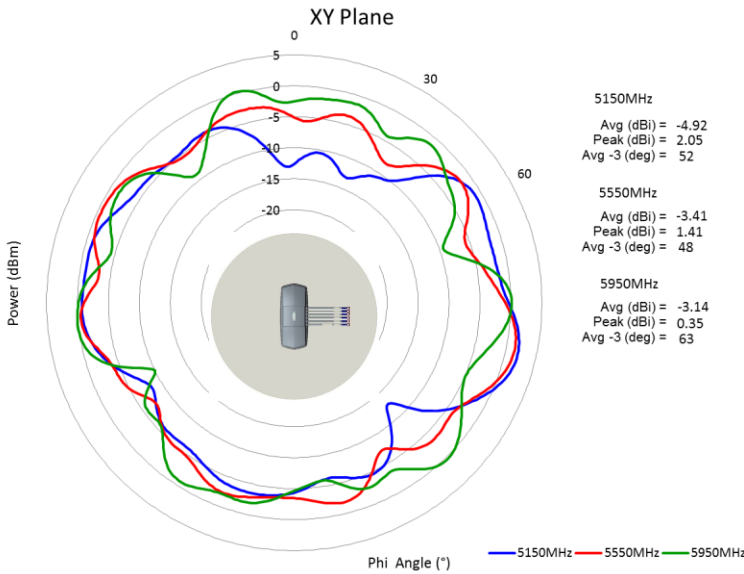

WiFi1 XY plane radiation pattern

WiFi2 XY plane radiation pattern

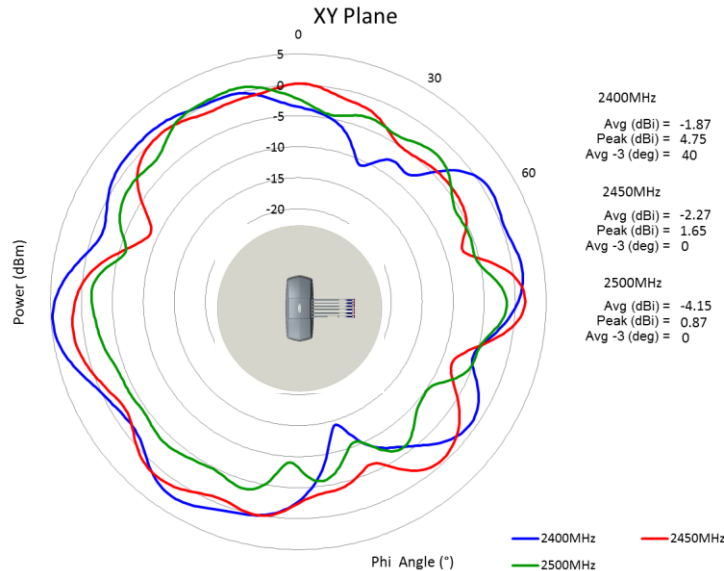

WiFi3 XY plane radiation pattern

Issue: 1842

In the effort to improve our products, we reserve the right to make changes judged to be necessary.

CONFIDENTIAL AND PROPRIETARY INFORMATION

This document contains confidential and proprietary information of Pulse Electronics, Inc. (Pulse) and is protected by copyright, trade secret and other state and federal laws. Its receipt or possession does not convey any rights to reproduce, disclose its contents, or to manufacture, use or sell anything it may describe. Reproduction, disclosure or use without specific written authorization of Pulse is strictly forbidden.

Description: Vehicular Multiband Antenna with Magnetic Mount

Series: ARMADILLO

PART NUMBER: ARMXXXXMM

CHARTS

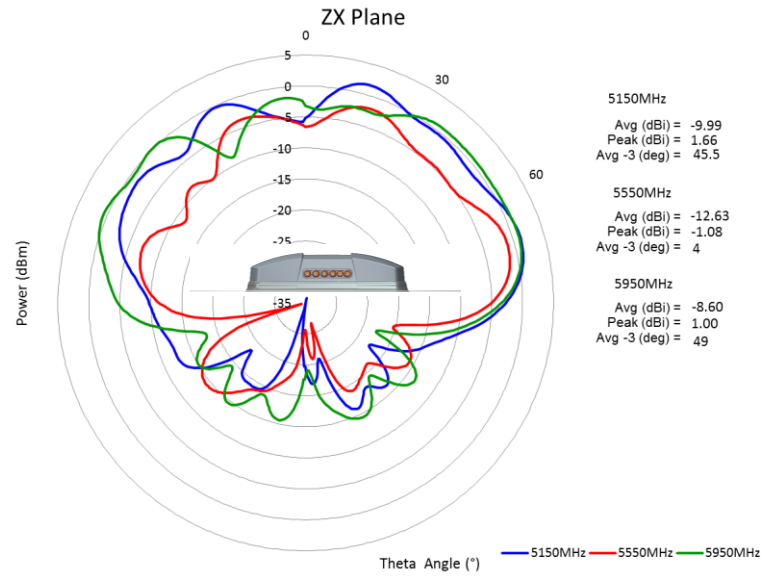
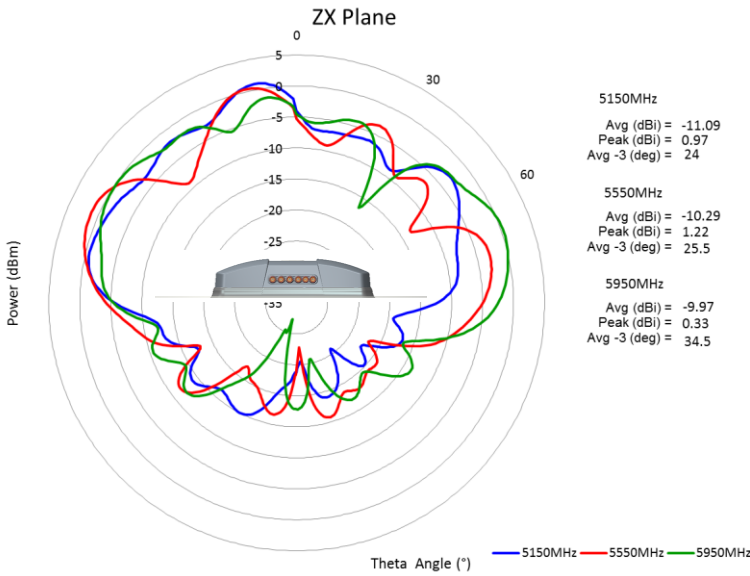

WiFi1 ZX plane radiation pattern

WiFi2 ZX plane radiation pattern

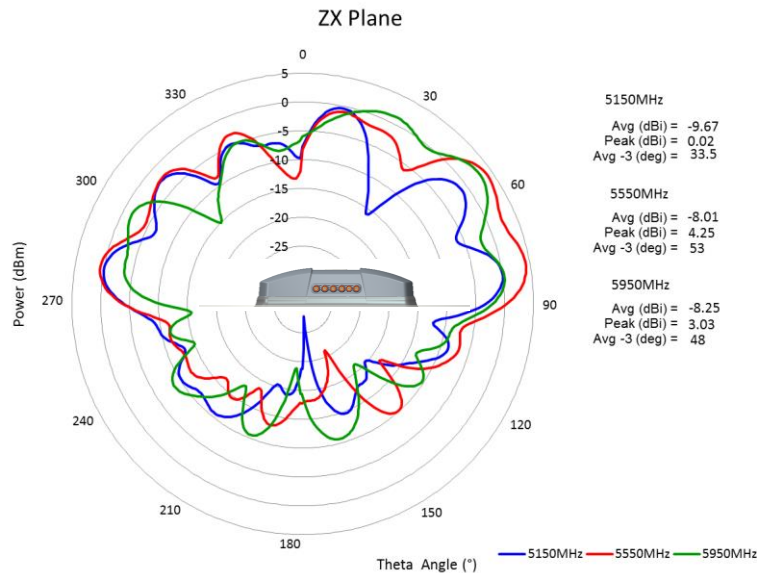

WiFi3 ZX plane radiation pattern

Issue: 1842

In the effort to improve our products, we reserve the right to make changes judged to be necessary.

CONFIDENTIAL AND PROPRIETARY INFORMATION

This document contains confidential and proprietary information of Pulse Electronics, Inc. (Pulse) and is protected by copyright, trade secret and other state and federal laws. Its receipt or possession does not convey any rights to reproduce, disclose its contents, or to manufacture, use or sell anything it may describe. Reproduction, disclosure or use without specific written authorization of Pulse is strictly forbidden.

Description: Vehicular Multiband Antenna with Magnetic Mount

Series: ARMADILLO

PART NUMBER: ARMXXXXMM

CHARTS

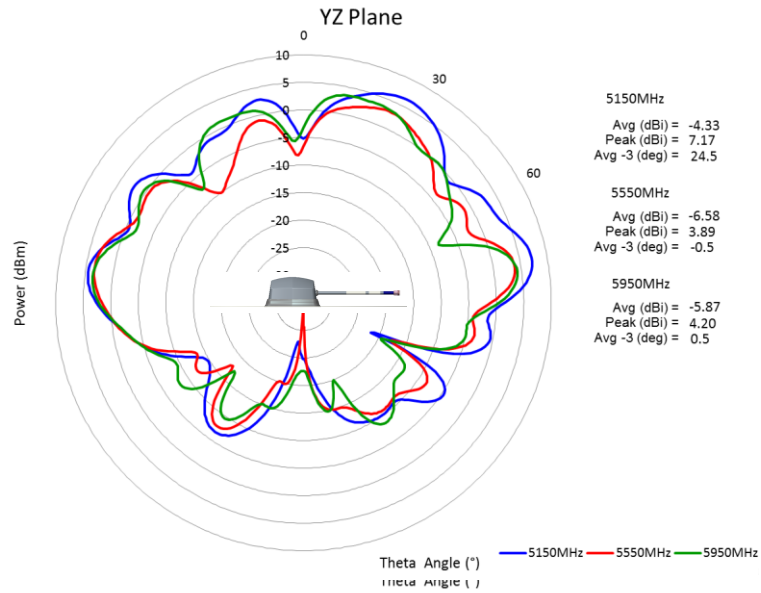
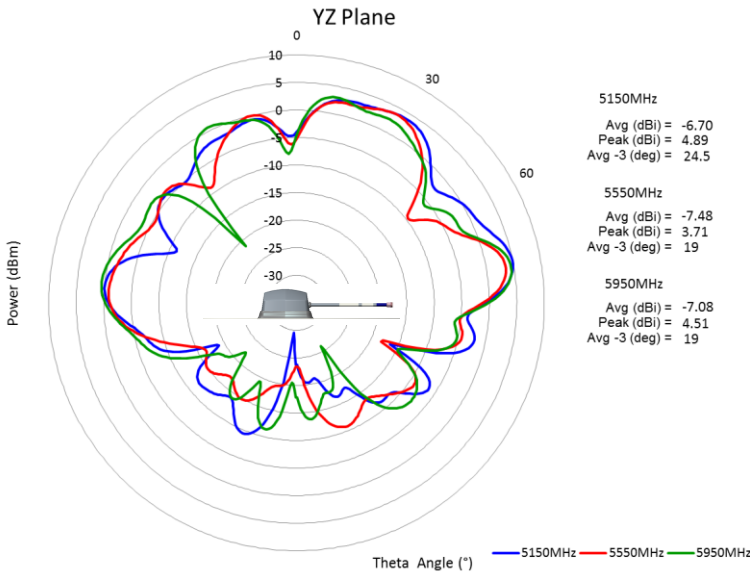

WiFi1 YZ plane radiation pattern

WiFi2 YZ plane radiation pattern

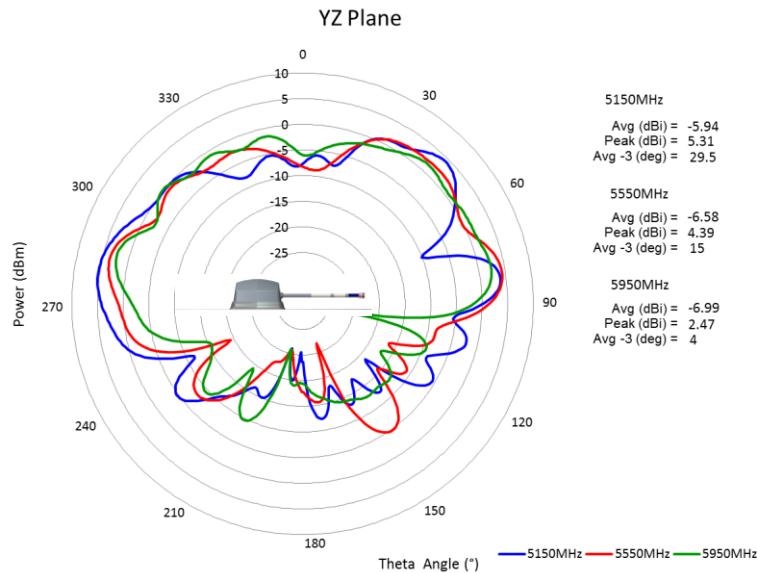

WiFi3 YZ plane radiation pattern

Issue: 1842

In the effort to improve our products, we reserve the right to make changes judged to be necessary.

CONFIDENTIAL AND PROPRIETARY INFORMATION

This document contains confidential and proprietary information of Pulse Electronics, Inc. (Pulse) and is protected by copyright, trade secret and other state and federal laws. Its receipt or possession does not convey any rights to reproduce, disclose its contents, or to manufacture, use or sell anything it may describe. Reproduction, disclosure or use without specific written authorization of Pulse is strictly forbidden.

Series: ARMADILLO

Description: Vehicular Multiband Antenna with
Magnetic Mount

PART NUMBER: ARMXXXXXMM

PACKAGING

Each antennas packed in Bubble Bag

6 bags of antennas (Total 6pcs) packed in a cardboard box

1 label on each box with quantity, part number, date code.