

**Part Number:**

254-PB148-ROX

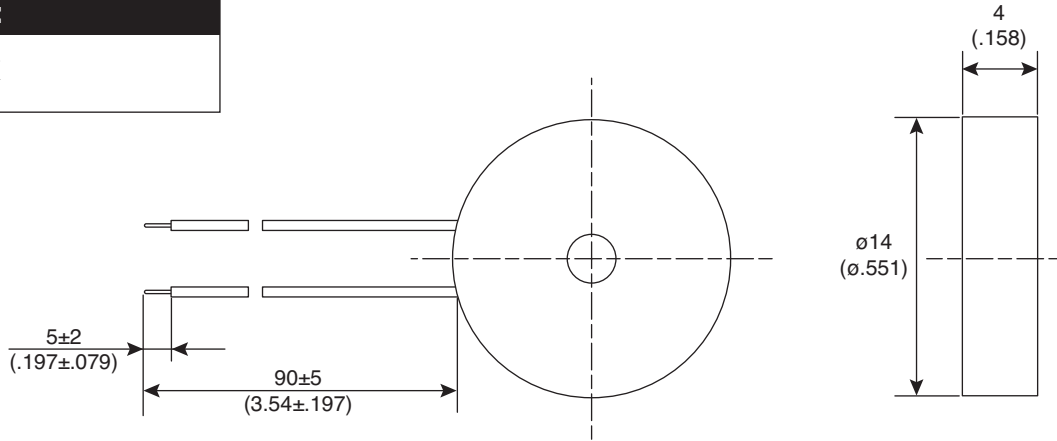

Piezoelectric Buzzer

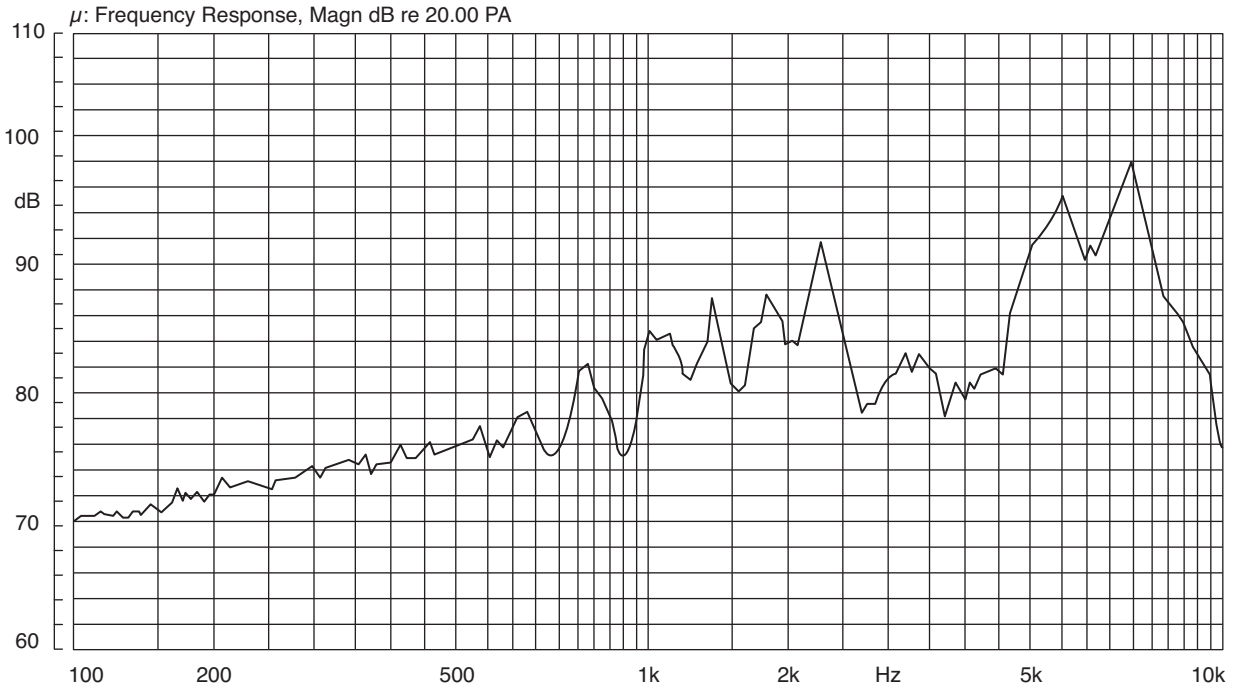

KT-400479

**Electrical Specifications:**

- Rated Voltage: 10 Vp-p
- Operating Voltage: 1~30 Vp-p
- Rated Current: 10mA (max.)
- Sound Output at 10cm: 85dBA
- Resonant Frequency: 4800Hz  $\pm$  50
- Capacitance at 120Hz: 15000pf  $\pm$  30%

**Mechanical Specifications:**

- Operating Temperature: -20°C ~ +70°C
- Storage Temperature: -30°C ~ +80°C

**Note:**

- RoHS Compliant by Exemption