



### Certifications & Ratings

- RoHS compliant
- IP66/IP67
- IK10
- NEMA 4X

### Application

The 623 Series Heavy Duty LED Panel Mount Indicators are elegantly designed for a high-end aesthetic paired with sturdy construction. These indicators are non-magnetic, corrosion resistant for both indoor and outdoor use, and secured to prevent dirt, dust, and water penetration. Ideal for a variety of applications such as:

- Main power indication
  - Remote power indication
  - Status indication
  - Maintenance and warning indication
  - Instrumentation
- ... and many more!

### Dimensions

inches [mm]

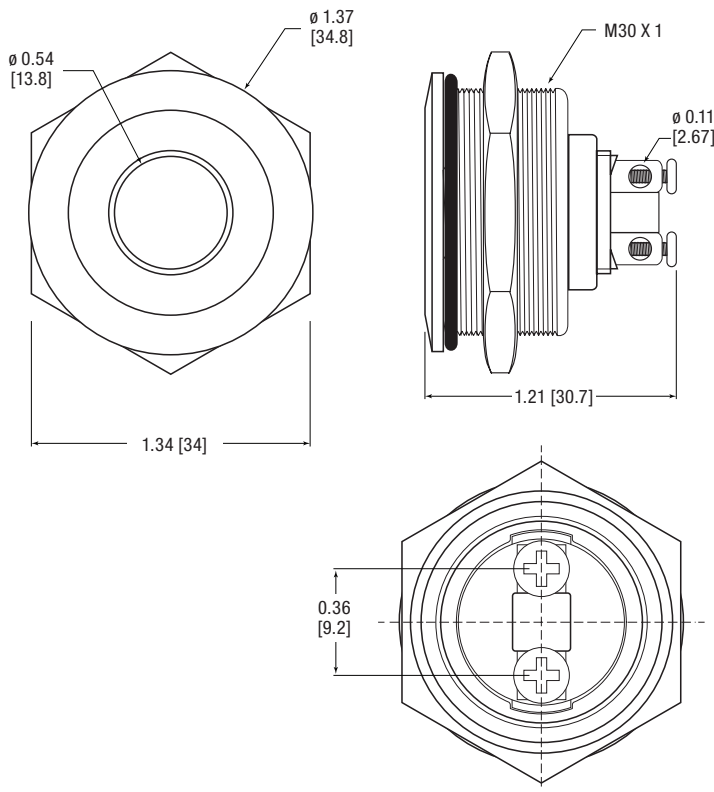

### Mechanical Information

<b>Mounting Hole Size:</b>	1.18" (30 mm)
<b>Max Panel Thickness:</b>	0.394" (10 mm)
<b>Mounting Torque:</b>	7.01 lbs-ft (9.5 Nm)

### Specifications

<b>Operating Voltage:</b>	3 VDC (external resistor required) 6, 12 & 24 VDC (internal resistor included)
<b>Operating Temp:</b>	-25 °C to +70 °C (-13 °F to 158 °F)
<b>Storage Temp:</b>	-25 °C to +70 °C (-13 °F to 158 °F)
<b>Electrical Connection:</b>	Screw terminals
<b>Housing:</b>	Stainless Steel
<b>Nut:</b>	Stainless Steel

## Ordering Information 623 Series

### Part Number Guide

RoHS Compliant

6	2	3	-	1	X	X	X	-	3	0	4	F
							Voltage					
							1	3VDC				
							2	6VDC				
							3	12VDC				
							4	24VDC				
Color					1	0						
● Red					1	0						
● Green					2	0						
● Yellow					3	0						
● Blue					4	0						

Dialight P/N	Color	Voltage (VDC)	Current (mA)	Typical Intensity (mcd)
623-1101-304F	● Red	3	15	200
623-1201-304F	● Green			250
623-1301-304F	● Yellow			350
623-1401-304F	● Blue			300
623-1102-304F	● Red	6		200
623-1202-304F	● Green			250
623-1302-304F	● Yellow			350
623-1402-304F	● Blue			300
623-1103-304F	● Red	12		200
623-1203-304F	● Green			250
623-1303-304F	● Yellow			350
623-1403-304F	● Blue			300
623-1104-304F	● Red	24		200
623-1204-304F	● Green			250
623-1304-304F	● Yellow			350
623-1404-304F	● Blue			300

Dialight reserves the right to make changes at any time in order to supply the best product possible. The most current version of this document will always be available at: [www.dialightsignalsandcomponents.com](http://www.dialightsignalsandcomponents.com)

**Warranty Statement:** Except for the warranty expressly provided for [herein/above/below], Dialight disclaims any and all other warranties, express or implied, including, without limitation, any warranties of merchantability, fitness for a particular purpose, title, and noninfringement.