

FEATURES

- 12°/hr bias stability
- Z-axis (yaw rate) response
- 0.01°/√sec angle random walk
- High vibration rejection over wide frequency
- Measurement range extendable to a maximum of ±450°/sec
- 10,000 g powered shock survivability
- Ratiometric to referenced supply
- 6 V single-supply operation
- −40°C to +105°C operation
- Self-test on digital command
- Ultrasmall and light (<0.15 cc, <0.5 gram)
- Temperature sensor output
- Complete rate gyroscope on a single chip
- RoHS compliant

APPLICATIONS

- Industrial applications
- Severe mechanical environments
- Platform stabilization

GENERAL DESCRIPTION

The [ADXRS646](#) is a high performance angular rate sensor (gyroscope) that offers excellent vibration immunity. Bias stability is a widely-recognized figure of merit for high performance gyroscopes, but in real-world applications, vibration sensitivity is often a more significant performance limitation and should be considered in gyroscope selection. The [ADXRS646](#) offers superior vibration immunity and acceleration rejection as well as a low bias drift of 12°/hr (typical), enabling it to offer rate sensing in harsh environments where shock and vibration are present.

The [ADXRS646](#) is manufactured using the Analog Devices, Inc., patented high volume BiMOS surface-micromachining process. An advanced, differential, quad sensor design provides the improved acceleration and vibration rejection. The output signal, RATEOUT, is a voltage proportional to angular rate about the axis normal to the top surface of the package. The measurement range is a minimum of ±250°/sec. The output is ratiometric with respect to a provided reference supply. Other external capacitors are required for operation.

A temperature output is provided for compensation techniques. Two digital self-test inputs electromechanically excite the sensor to test proper operation of both the sensor and the signal conditioning circuits.

The [ADXRS646](#) is available in a 7 mm × 7 mm × 3 mm CBGA chip-scale package.

FUNCTIONAL BLOCK DIAGRAM

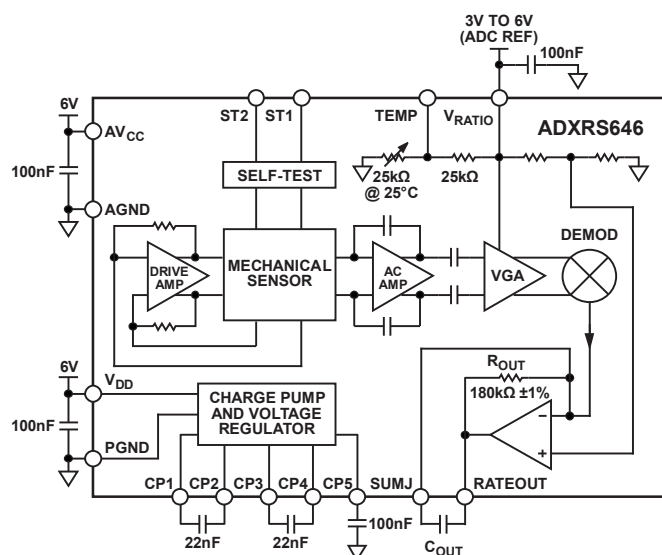

Figure 1.

Rev. C

[Document Feedback](#)

Information furnished by Analog Devices is believed to be accurate and reliable. However, no responsibility is assumed by Analog Devices for its use, nor for any infringements of patents or other rights of third parties that may result from its use. Specifications subject to change without notice. No license is granted by implication or otherwise under any patent or patent rights of Analog Devices. Trademarks and registered trademarks are the property of their respective owners.

One Technology Way, P.O. Box 9106, Norwood, MA 02062-9106, U.S.A.
 Tel: 781.329.4700 ©2011–2017 Analog Devices, Inc. All rights reserved.
[Technical Support](#) www.analog.com

TABLE OF CONTENTS

Features	1	Theory of Operation	9
Applications.....	1	Setting Bandwidth.....	9
General Description	1	Temperature Output and Calibration.....	9
Functional Block Diagram	1	Supply Ratiometricity	10
Revision History	2	Null Adjustment	10
Specifications.....	3	Self-Test Function	10
Absolute Maximum Ratings.....	4	Continuous Self-Test.....	10
Rate Sensitive Axis	4	Modifying the Measurement Range	10
ESD Caution.....	4	Immunity to Vibration	11
Pin Configuration and Function Descriptions.....	5	Outline Dimensions	12
Typical Performance Characteristics	6	Ordering Guide	12

REVISION HISTORY

1/2017—Rev. B to Rev. C		9/2012—Rev. 0 to Rev. A	
Changes to Initial Parameter, Table 1	3	Changes to Figure 1.....	1
1/2014—Rev. A to Rev. B		Changes to Figure 9.....	6
Changes to Table 1.....	3	9/2011—Revision 0: Initial Version	
Changes to Figure Captions, Typical Performance Characteristics Section.....	6		
Replaced Figure 8	6		
Changes to Continuous Self-Test Section	10		

SPECIFICATIONS

All minimum and maximum specifications are guaranteed. Typical specifications are not guaranteed.

$T_A = 25^\circ\text{C}$, $V_S = AV_{CC} = V_{DD} = 6\text{ V}$, $V_{RATIO} = AV_{CC}$, angular rate = $0^\circ/\text{sec}$, bandwidth = 80 Hz ($C_{OUT} = 0.01\ \mu\text{F}$), $I_{OUT} = 100\ \mu\text{A}$, $\pm 1\text{ g}$, unless otherwise noted.

Table 1.

Parameter	Test Conditions/Comments	Min	Typ	Max	Unit
SENSITIVITY ¹	Clockwise rotation is positive output				
Measurement Range ²	Full-scale range over specifications range	± 250	± 300		$^\circ/\text{sec}$
Initial		7.5	9	10.5	$\text{mV}/^\circ/\text{sec}$
Temperature Drift ³			± 6.5		%
Nonlinearity	Best fit straight line		0.01		% of FS
NULL ¹					
Null	-40°C to $+105^\circ\text{C}$	2.7	3.0	3.3	V
Temperature Drift ³			± 3		$^\circ/\text{sec}$
Linear Acceleration Effect	Any axis		0.015		$^\circ/\text{sec}/\text{g}$
Vibration Rectification	25 g rms, 50 Hz to 5 kHz		0.0001		$^\circ/\text{sec}/\text{g}^2$
NOISE PERFORMANCE					
Rate Noise Density	$T_A \leq 25^\circ\text{C}$		0.01		$^\circ/\text{sec}/\sqrt{\text{Hz}}$
Rate Noise Density	$T_A \leq 105^\circ\text{C}$		0.015		$^\circ/\text{sec}/\sqrt{\text{Hz}}$
Resolution Floor	$T_A = 25^\circ\text{C}$, 1 minute to 1 hour in-run		12		$^\circ/\text{hr}$
FREQUENCY RESPONSE					
Bandwidth ⁴	$\pm 3\text{ dB}$ user adjustable up to specification		1000		Hz
Sensor Resonant Frequency		15.5	17.5	20	kHz
SELF-TEST ¹					
ST1 RATEOUT Response	ST1 pin from Logic 0 to Logic 1		-50		$^\circ/\text{sec}$
ST2 RATEOUT Response	ST2 pin from Logic 0 to Logic 1		50		$^\circ/\text{sec}$
ST1 to ST2 Mismatch ⁵		-5	± 0.5	+5	%
Logic 1 Input Voltage	ST1 pin or ST2 pin	4			V
Logic 0 Input Voltage				2	V
Input Impedance	ST1 pin or ST2 pin to common	40	50	100	k Ω
TEMPERATURE SENSOR ¹					
V_{OUT} at 25°C	Load = 10 M Ω	2.8	2.9	3.0	V
Scale Factor ⁶	25°C , $V_{RATIO} = 6\text{ V}$		10		$\text{mV}/^\circ\text{C}$
Load to V_S			25		k Ω
Load to Common			25		k Ω
TURN-ON TIME ⁶	Power on to $\pm 0.5^\circ/\text{sec}$ of final with $CP5 = 100\text{ nF}$			50	ms
OUTPUT DRIVE CAPABILITY					
Current Drive	For rated specifications			200	μA
Capacitive Load Drive				1000	pF
POWER SUPPLY					
Operating Voltage (V_S)		5.75	6.00	6.25	V
Quiescent Supply Current			4		mA
TEMPERATURE RANGE					
Specified Performance		-40		+105	$^\circ\text{C}$

¹ Parameter is linearly ratiometric with V_{RATIO} .

² Measurement range is the maximum range possible, including output swing range, initial offset, sensitivity, offset drift, and sensitivity drift at 5 V supplies.

³ From $+25^\circ\text{C}$ to -40°C or $+25^\circ\text{C}$ to $+105^\circ\text{C}$.

⁴ Adjusted by external capacitor, C_{OUT} . Reducing bandwidth below 0.01 Hz does not result in further noise improvement.

⁵ Self-test mismatch is described as $(ST2 + ST1)/((ST2 - ST1)/2)$.

⁶ Based on characterization.

ABSOLUTE MAXIMUM RATINGS

Table 2.

Parameter	Rating
Acceleration (Any Axis, 0.5 ms)	
Unpowered	10,000 g
Powered	10,000 g
V_{DD}, AV_{CC}	-0.3 V to +6.6 V
V_{RATIO}	AV_{CC}
ST1, ST2	AV_{CC}
Output Short-Circuit Duration (Any Pin to Common)	Indefinite
Operating Temperature Range	-55°C to +125°C
Storage Temperature Range	-65°C to +150°C

Stresses at or above those listed under Absolute Maximum Ratings may cause permanent damage to the product. This is a stress rating only; functional operation of the product at these or any other conditions above those indicated in the operational section of this specification is not implied. Operation beyond the maximum operating conditions for extended periods may affect product reliability.

Drops onto hard surfaces can cause shocks of greater than 10,000 g and can exceed the absolute maximum rating of the device. Care should be exercised in handling to avoid damage.

RATE SENSITIVE AXIS

This is a Z-axis rate-sensing device (also called a yaw rate-sensing device). It produces a positive going output voltage for clockwise rotation about the axis normal to the package top, that is, clockwise when looking down at the package lid.

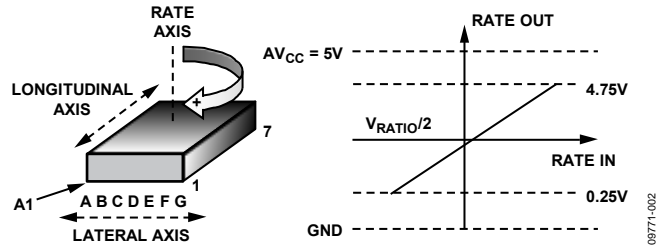

Figure 2. RATEOUT Signal Increases with Clockwise Rotation

ESD CAUTION



ESD (electrostatic discharge) sensitive device. Charged devices and circuit boards can discharge without detection. Although this product features patented or proprietary protection circuitry, damage may occur on devices subjected to high energy ESD. Therefore, proper ESD precautions should be taken to avoid performance degradation or loss of functionality.

PIN CONFIGURATION AND FUNCTION DESCRIPTIONS

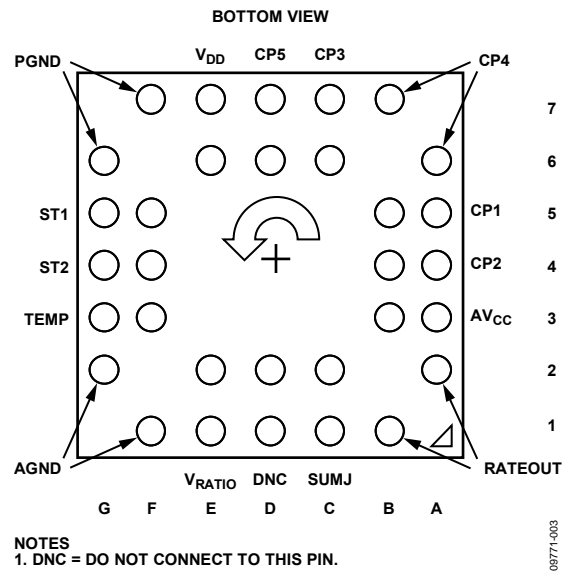

Figure 3. Pin Configuration

Table 3. Pin Function Descriptions

Pin No.	Mnemonic	Description
6D, 7D	CP5	HV Filter Capacitor, 100nF (±5%).
6A, 7B	CP4	Charge Pump Capacitor, 22 nF (±5%).
6C, 7C	CP3	Charge Pump Capacitor, 22 nF (±5%).
5A, 5B	CP1	Charge Pump Capacitor, 22 nF (±5%).
4A, 4B	CP2	Charge Pump Capacitor, 22 nF (±5%).
3A, 3B	AV _{CC}	Positive Analog Supply.
1B, 2A	RATEOUT	Rate Signal Output.
1C, 2C	SUMJ	Output Amp Summing Junction.
1D, 2D	DNC	Do Not Connect to this Pin.
1E, 2E	V _{RATIO}	Reference Supply for Ratiometric Output.
1F, 2G	AGND	Analog Supply Return.
3F, 3G	TEMP	Temperature Voltage Output.
4F, 4G	ST2	Self-Test for Sensor 2.
5F, 5G	ST1	Self-Test for Sensor 1.
6G, 7F	PGND	Charge Pump Supply Return.
6E, 7E	V _{DD}	Positive Charge Pump Supply.

TYPICAL PERFORMANCE CHARACTERISTICS

N > 1000 for all typical performance plots, unless otherwise noted.

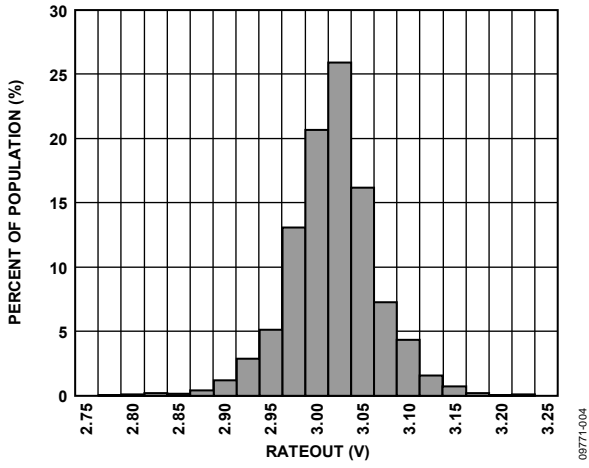

Figure 4. Null Bias at 25°C

09771-004

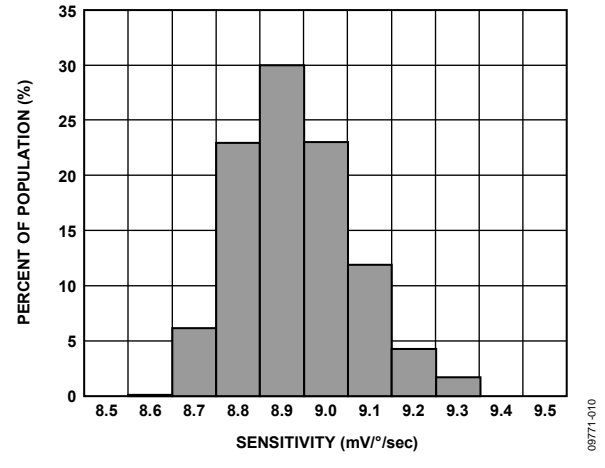

Figure 7. Sensitivity at 25°C

09771-010

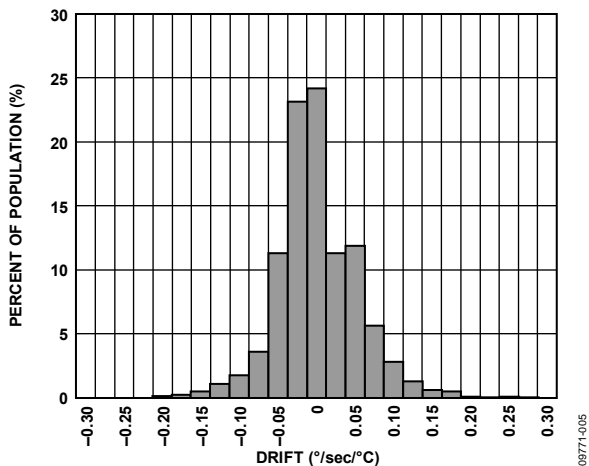

Figure 5. Null Drift over Temperature

09771-005

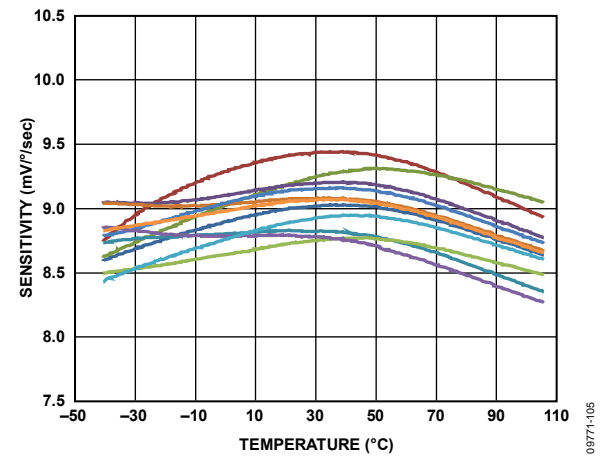

Figure 8. Sensitivity over Temperature, 16 Parts in Sockets

09771-105

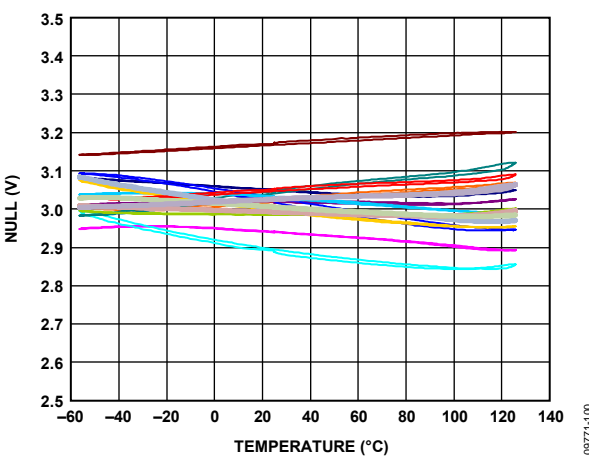

Figure 6. Null Output over Temperature, 16 Parts in Sockets

09771-100

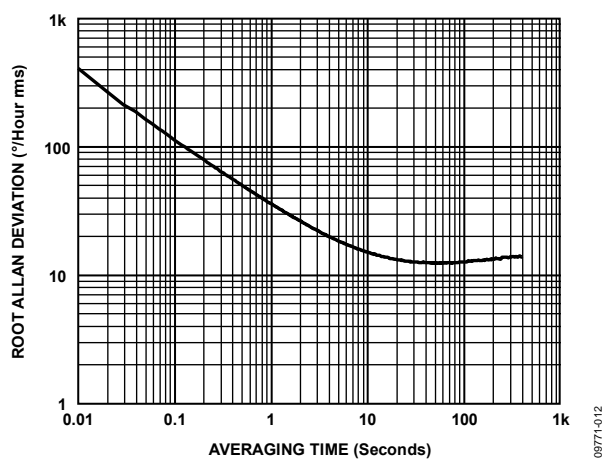

Figure 9. Typical Root Allan Deviation at 25°C vs. Averaging Time

09771-012

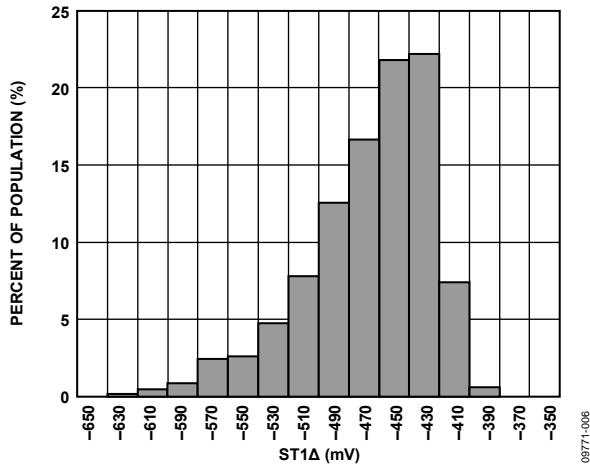

Figure 10. ST1 Output Change at 25°C

08771-006

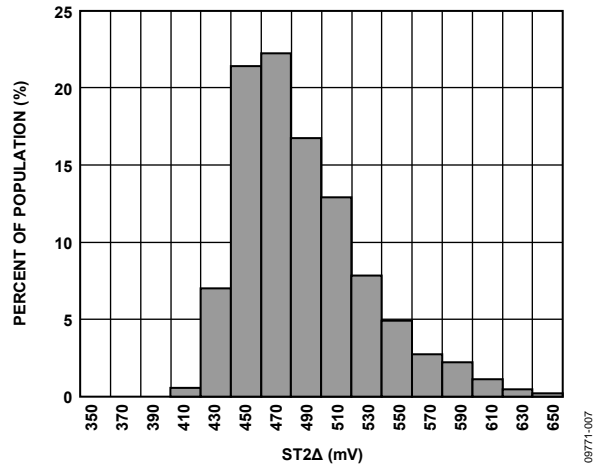

Figure 13. ST2 Output Change at 25°C

08771-007

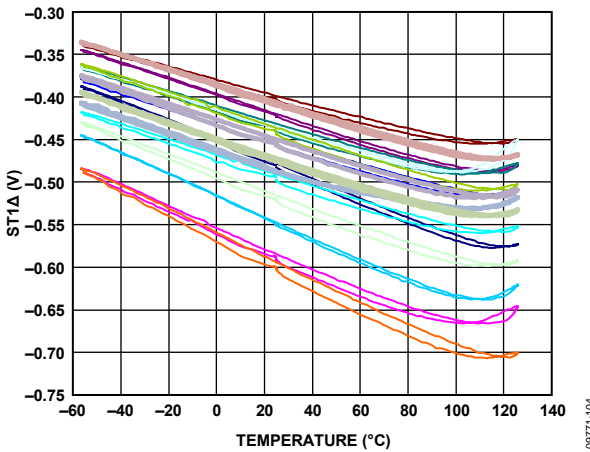

Figure 11. ST1 Output Change vs. Temperature, 16 Parts in Sockets

08771-104

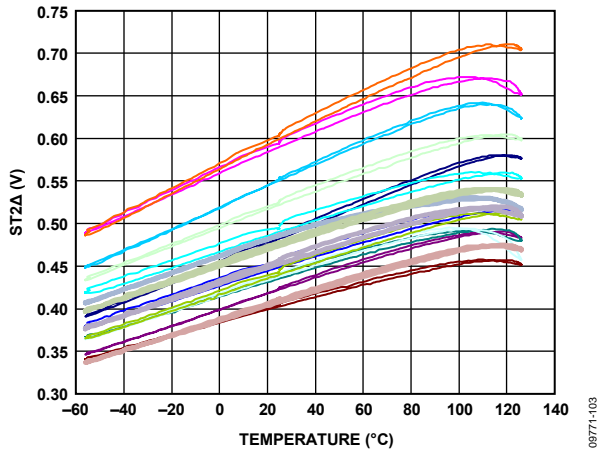

Figure 14. ST2 Output Change vs. Temperature, 16 Parts in Sockets

08771-103

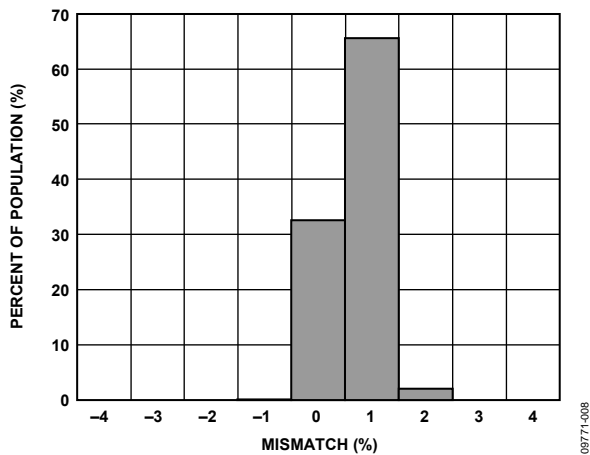

Figure 12. Self-Test Mismatch at 25°C

08771-008

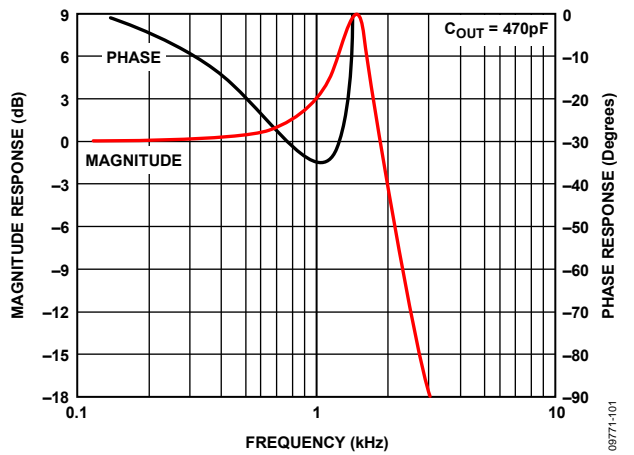

Figure 15. ADXRS646 Frequency Response with a 2.2 kHz Output Filter

08771-101

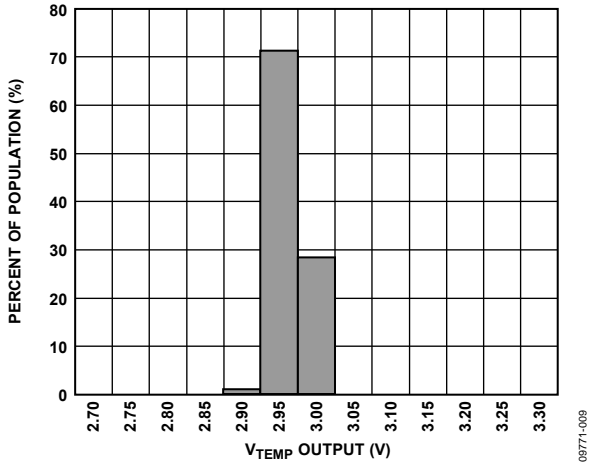

Figure 16. V_{TEMP} Output at 25°C

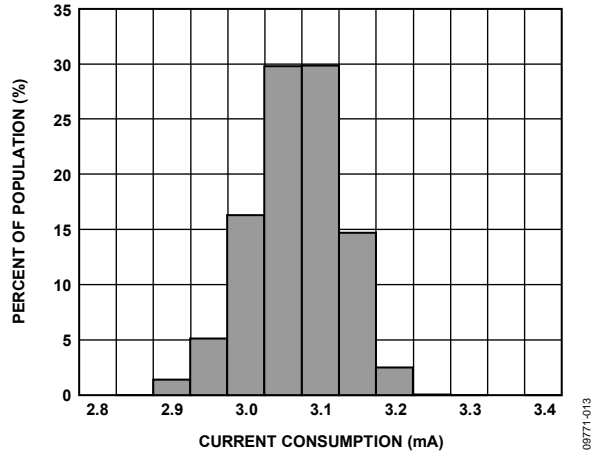

Figure 18. Current Consumption at 25°C

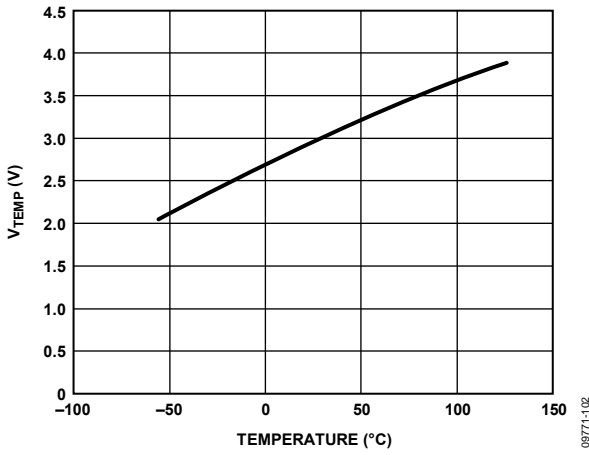

Figure 17. V_{TEMP} Output vs. Temperature

THEORY OF OPERATION

The ADXRS646 operates on the principle of a resonator gyroscope. Figure 19 shows a simplified version of one of four polysilicon sensing structures. Each sensing structure contains a dither frame that is electrostatically driven to resonance. This produces the necessary velocity element to produce a Coriolis force when experiencing angular rate. The ADXRS646 is designed to sense a Z-axis (yaw) angular rate.

When the sensing structure is exposed to angular rate, the resulting Coriolis force couples into an outer sense frame, which contains movable fingers that are placed between fixed pickoff fingers. This forms a capacitive pickoff structure that senses Coriolis motion. The resulting signal is fed to a series of gain and demodulation stages that produce the electrical rate signal output. The quad sensor design rejects linear and angular acceleration, including external g -forces, shock, and vibration. The rejection is achieved by mechanically coupling the four sensing structures such that external g -forces appear as common-mode signals that can be removed by the fully differential architecture implemented in the ADXRS646.

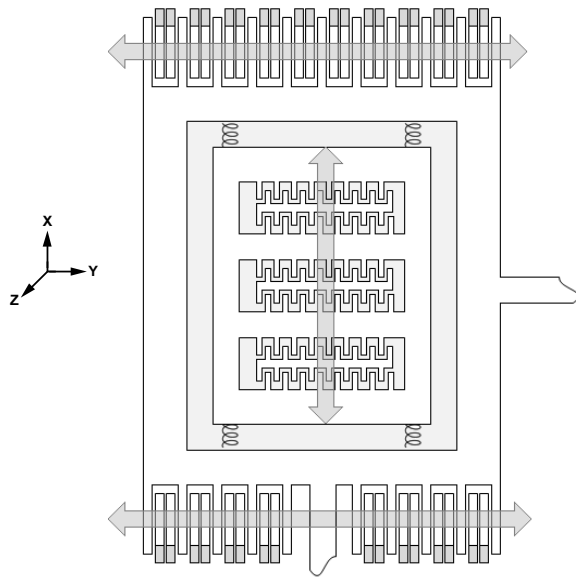

Figure 19. Simplified Gyroscope Sensing Structure—One Corner

The electrostatic resonator requires 21 V for operation. Because only 6 V are typically available in most applications, a charge pump is included on chip. If an external 21 V supply is available, the two capacitors on CP1 to CP4 can be omitted, and this supply can be connected to CP5 (Pin 6D, Pin 7D). CP5 should not be grounded when power is applied to the ADXRS646. No damage occurs, but under certain conditions, the charge pump may fail to start up after the ground is removed without first removing power from the ADXRS646.

SETTING BANDWIDTH

The combination of an external capacitor (C_{OUT}) and the on-chip resistor (R_{OUT}) creates a low-pass filter that limits the bandwidth of the ADXRS646 rate response. The -3 dB frequency set by R_{OUT} and C_{OUT} is

$$f_{OUT} = 1/(2 \times \pi \times R_{OUT} \times C_{OUT})$$

and can be well controlled because R_{OUT} is trimmed during manufacturing to $180 \text{ k}\Omega \pm 1\%$. Any external resistor applied between the RATEOUT pin (1B, 2A) and SUMJ pin (1C, 2C) results in

$$R_{OUT} = (180 \text{ k}\Omega \times R_{EXT}) / (180 \text{ k}\Omega + R_{EXT})$$

An additional external filter is often added (in either hardware or software) to attenuate high frequency noise arising from demodulation spikes at the 18 kHz resonant frequency of the gyroscope. An RC output filter consisting of a 3.3 k Ω series resistor and 22 nF shunt capacitor (2.2 kHz pole) is recommended.

TEMPERATURE OUTPUT AND CALIBRATION

It is common practice to temperature-calibrate gyroscopes to improve their overall accuracy. The ADXRS646 has a temperature-dependent voltage output that provides input to such a calibration method. The temperature sensor structure is shown in Figure 20. The temperature output is characteristically nonlinear, and any load resistance connected to the TEMP output results in decreasing the TEMP output and its temperature coefficient. Therefore, buffering the output is recommended.

The voltage at TEMP (3F, 3G) is nominally 2.9 V at 25°C, and $V_{RATIO} = 6$ V. The temperature coefficient is 10 mV/°C (typical) at 25°C; the output response over the full temperature range is shown in Figure 17. Although the TEMP output is highly repeatable, it has only modest absolute accuracy.

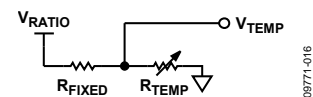

Figure 20. Temperature Sensor Structure

SUPPLY RATIOMETRICITY

The null output voltage (RATEOUT), sensitivity, self-test responses (ST1 and ST2), and temperature output (TEMP) of the ADXRS646 are ratiometric to V_{RATIO} . Therefore, using the ADXRS646 with a supply-ratiometric ADC results in self-cancellation of errors resulting from minor supply variations. There remains a small, usually negligible, error due to non-ratiometric behavior. Note that, to guarantee full measurement range, V_{RATIO} should not be greater than AV_{CC} .

NULL ADJUSTMENT

The nominal 3.0 V null output voltage is true for a symmetrical swing range at RATEOUT (1B, 2A). However, an asymmetric output swing may be suitable in some applications. Null adjustment is possible by injecting a suitable current to SUMJ (1C, 2C). Note that supply disturbances may cause some null instability. Digital supply noise should be avoided, particularly in this case.

SELF-TEST FUNCTION

The ADXRS646 includes a self-test feature that actuates each of the sensing structures and associated electronics in the same manner as if the gyroscope were subjected to angular rate.

Self-test is activated by applying the standard logic high level ST1 pin (5F, 5G), the ST2 pin (4F, 4G), or both. Applying a logic high to Pin ST1 causes the voltage at RATEOUT to change by -450 mV (typical), and applying a logic high to Pin ST2 causes an opposite change of $+450$ mV (typical). The voltage applied to the ST1 and ST2 pins must never be greater than AV_{CC} . The self-test response follows the temperature dependence of the viscosity of the package atmosphere, approximately $0.25\%/^{\circ}\text{C}$.

Activating both ST1 and ST2 simultaneously is not damaging. The output responses generated by ST1 and ST2 are closely matched ($\pm 2\%$), but actuating both simultaneously may result in a small apparent null bias shift proportional to the degree of self-test mismatch.

CONTINUOUS SELF-TEST

The on-chip integration of the ADXRS646, as well as the mature process with which it is manufactured, have provided the gyroscope with field-proven reliability.

As an additional failure detection measure, self-test can be performed at power-up or occasionally during operation. However, some applications may require continuous self-test while sensing rotation rate.

MODIFYING THE MEASUREMENT RANGE

The ADXRS646 scale factor can be reduced to extend the measurement range to as much as $\pm 450^{\circ}/\text{sec}$ by adding a single 225 k Ω resistor between RATEOUT and SUMJ. If an external resistor is added between RATEOUT and SUMJ, C_{OUT} must be proportionally increased to maintain correct bandwidth.

IMMUNITY TO VIBRATION

Gyroscopes are designed to respond only to rotation. However, all gyroscopes respond to linear motion as well, to varying degrees. While bias stability is often used as the primary figure of merit for evaluating high performance gyroscopes, many additional error sources are present in real-world applications. Especially in applications that require motion sensors, vibration and acceleration are present, and the resulting errors often overwhelm bias drift.

Its differential, quad-sensor design makes the ADXRS646 inherently resistant to vibration, without the need for compensation. The excellent vibration immunity of the ADXRS646 is demonstrated in Figure 21 and Figure 22. Figure 21 shows the ADXRS646 output response with and without random 15 g rms vibration applied at 20 Hz to 2 kHz. Performance is similar regardless of the direction of input vibration.

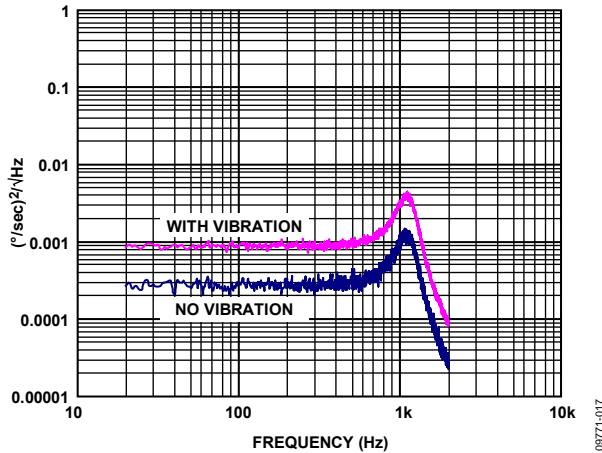

Figure 21. ADXRS646 Output Response With and Without Random Vibration (15 g RMS, 20 Hz to 2 kHz); Gyroscope Bandwidth Set to 1600 Hz

To further improve immunity to vibration and acceleration, some g-sensitivity compensation can be performed using an accelerometer. This technique is most successful when the response to vibration is constant regardless of vibration frequency. Figure 22 demonstrates the ADXRS646 dc bias response to a 5 g sinusoidal vibration over the 20 Hz to 5 kHz range. This figure shows that there are no sensitive frequencies present and that vibration rectification is vanishingly small. Accordingly, g-sensitivity compensation using an accelerometer is possible where needed, but the inherent device performance is sufficient for many applications.

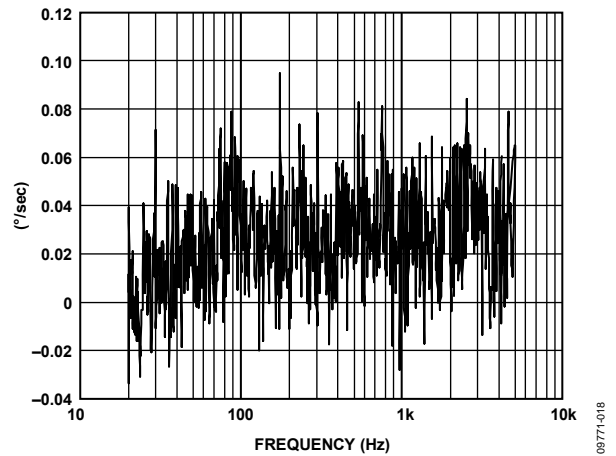
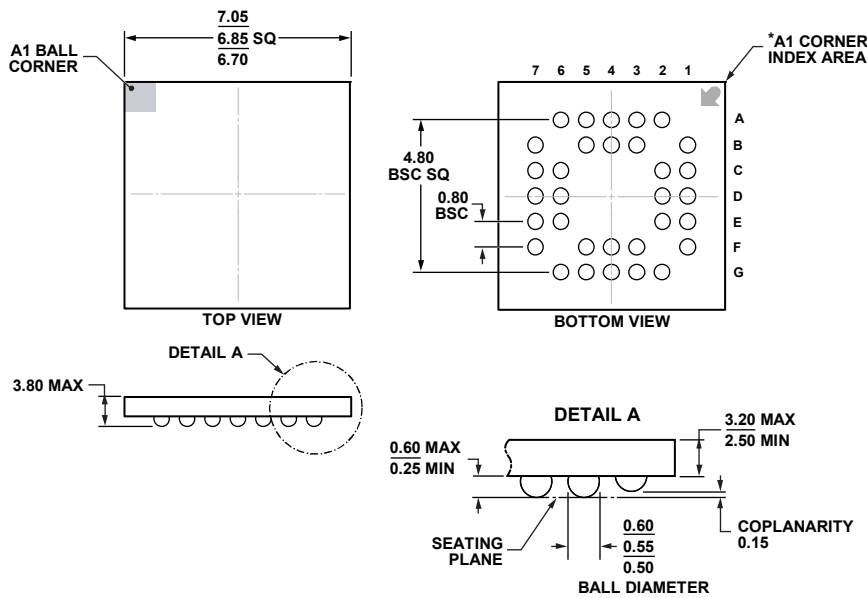

Figure 22. ADXRS646 Sine Vibration Output Response (5 g, 20 Hz to 5 kHz); Gyroscope Bandwidth Set to 1600 Hz

OUTLINE DIMENSIONS



*BALL A1 IDENTIFIER IS GOLD PLATED AND CONNECTED TO THE D/A PAD INTERNALLY VIA HOLES.

Figure 23. 32-Lead Ceramic Ball Grid Array [CBGA] (BG-32-3)

Dimensions shown in millimeters

07-11-2012-B

ORDERING GUIDE

Model ¹	Temperature Range	Package Description	Package Option
ADXRS646BBGZ	-40°C to +105°C	32-Lead Ceramic Ball Grid Array [CBGA]	BG-32-3
ADXRS646BBGZ-RL	-40°C to +105°C	32-Lead Ceramic Ball Grid Array [CBGA]	BG-32-3
EVAL-ADXRS646Z		Evaluation Board	

¹ Z = RoHS Compliant Part.