

# IGBT Modules

## Sixpack

Short Circuit SOA Capability  
Square RBSOA

$I_{C25} = 125 \text{ A}$   
 $V_{CES} = 1200 \text{ V}$   
 $V_{CE(sat) \text{ typ.}} = 2.2 \text{ V}$

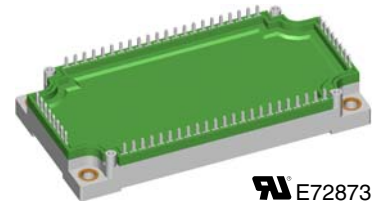
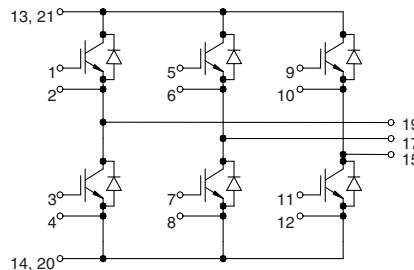

**IXYS** E72873

See outline drawing for pin arrangement

IGBTs		
Symbol	Conditions	Maximum Ratings
$V_{CES}$	$T_{VJ} = 25^{\circ}\text{C to } 150^{\circ}\text{C}$	1200 V
$V_{GES}$		$\pm 20$ V
$I_{C25}$	$T_C = 25^{\circ}\text{C}$	125 A
$I_{C80}$	$T_C = 80^{\circ}\text{C}$	85 A
<b>RBSOA</b>	$V_{GE} = \pm 15 \text{ V}; R_G = 15 \Omega; T_{VJ} = 125^{\circ}\text{C}$ Clamped inductive load; $L = 100 \mu\text{H}$	$I_{CM} = 150$ $V_{CEK} \leq V_{CES}$ A
$t_{SC}$ <b>(SCSOA)</b>	$V_{CE} = V_{CES}; V_{GE} = \pm 15 \text{ V}; R_G = 15 \Omega; T_{VJ} = 125^{\circ}\text{C}$ non-repetitive	10 $\mu\text{s}$
$P_{tot}$	$T_C = 25^{\circ}\text{C}$	500 W

### Features

- €NPT IGBT technology
- €low saturation voltage
- €low switching losses
- €switching frequency up to 30 kHz
- €square RBSOA, no latch up
- €high short circuit capability
- €positive temperature coefficient for easy paralleling
- €MOS input, voltage controlled
- €ultra fast free wheeling diodes
- €solderable pins for PCB mounting
- €package with copper base plate

### Advantages

- €space savings
- €reduced protection circuits
- €package designed for wave soldering

### Typical Applications

- €AC motor control
- €AC servo and robot drives
- €power supplies

Symbol	Conditions	Characteristic Values ( $T_{VJ} = 25^{\circ}\text{C}$ , unless otherwise specified)		
		min.	typ.	max.
$V_{CE(sat)}$	$I_C = 75 \text{ A}; V_{GE} = 15 \text{ V}; T_{VJ} = 25^{\circ}\text{C}$ $T_{VJ} = 125^{\circ}\text{C}$		2.2 2.5	V V
$V_{GE(th)}$	$I_C = 3 \text{ mA}; V_{GE} = V_{CE}$	4.5		6.5 V
$I_{CES}$	$V_{CE} = V_{CES}; V_{GE} = 0 \text{ V}; T_{VJ} = 25^{\circ}\text{C}$ $T_{VJ} = 125^{\circ}\text{C}$		3	5 mA mA
$I_{GES}$	$V_{CE} = 0 \text{ V}; V_{GE} = \pm 20 \text{ V}$			400 nA
$t_{d(on)}$ $t_r$ $t_{d(off)}$ $t_f$ $E_{on}$ $E_{off}$	Inductive load, $T_{VJ} = 125^{\circ}\text{C}$ $V_{CE} = 600 \text{ V}; I_C = 75 \text{ A}$ $V_{GE} = \pm 15 \text{ V}; R_G = 15 \Omega$		100 50 650 50	ns ns ns ns
				12.1 10.5
$C_{ies}$	$V_{CE} = 25 \text{ V}; V_{GE} = 0 \text{ V}; f = 1 \text{ MHz}$		5.5	nF
$Q_{Gon}$	$V_{CE} = 600 \text{ V}; V_{GE} = 15 \text{ V}; I_C = 75 \text{ A}$		350	nC
$R_{thJC}$	(per IGBT)			0.25 K/W

IXYS reserves the right to change limits, test conditions and dimensions.

20070912a

## Diodes

Symbol	Conditions	Maximum Ratings	
$I_{F25}$	$T_C = 25^\circ\text{C}$	150	A
$I_{F80}$	$T_C = 80^\circ\text{C}$	100	A

Symbol	Conditions	Characteristic Values		
		min.	typ.	max.
$V_F$	$I_F = 75\text{ A}; V_{GE} = 0\text{ V}; T_{VJ} = 25^\circ\text{C}$ $T_{VJ} = 125^\circ\text{C}$	2.2	2.6	V
$I_{RM}$ $t_{rr}$	$I_F = 75\text{ A}; di_F/dt = -750\text{ A}/\mu\text{s}; T_{VJ} = 125^\circ\text{C}$ $V_R = 600\text{ V}; V_{GE} = 0\text{ V}$	79		A
		220		ns
$R_{thJC}$	(per diode)			0.41 K/W

## Module

Symbol	Conditions	Maximum Ratings	
$T_{VJ}$	operating	-40...+125	$^\circ\text{C}$
$T_{JM}$		+150	$^\circ\text{C}$
$T_{stg}$		-40...+125	$^\circ\text{C}$
$V_{ISOL}$	$I_{ISOL} \leq 1\text{ mA}; 50/60\text{ Hz}$	2500	V~
$M_d$	Mounting torque (M5)	3 - 6	Nm

Symbol	Conditions	Characteristic Values		
		min.	typ.	max.
$R_{pin-chip}$			1.8	m $\Omega$
$d_S$	Creepage distance on surface	10		mm
$d_A$	Strike distance in air	10		mm
$R_{thCH}$	with heatsink compound		0.01	K/W
Weight			300	g

## Equivalent Circuits for Simulation

### Conduction

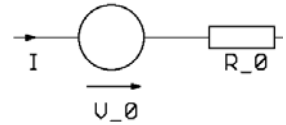

IGBT (typ. at  $V_{GE} = 15\text{ V}; T_J = 125^\circ\text{C}$ )  
 $V_0 = 1.5\text{ V}; R_0 = 13.5\text{ m}\Omega$

Free Wheeling Diode (typ. at  $T_J = 125^\circ\text{C}$ )  
 $V_0 = 1.3\text{ V}; R_0 = 4\text{ m}\Omega$

### Thermal Response

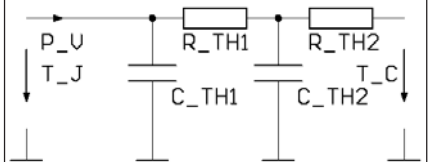

IGBT (typ.)  
 $C_{th1} = 0.295\text{ J/K}; R_{th1} = 0.186\text{ K/W}$   
 $C_{th2} = 1.750\text{ J/K}; R_{th2} = 0.064\text{ K/W}$

Free Wheeling Diode (typ.)  
 $C_{th1} = 0.227\text{ J/K}; R_{th1} = 0.321\text{ K/W}$   
 $C_{th2} = 1.328\text{ J/K}; R_{th2} = 0.089\text{ K/W}$

## Dimensions in mm (1 mm = 0.0394")

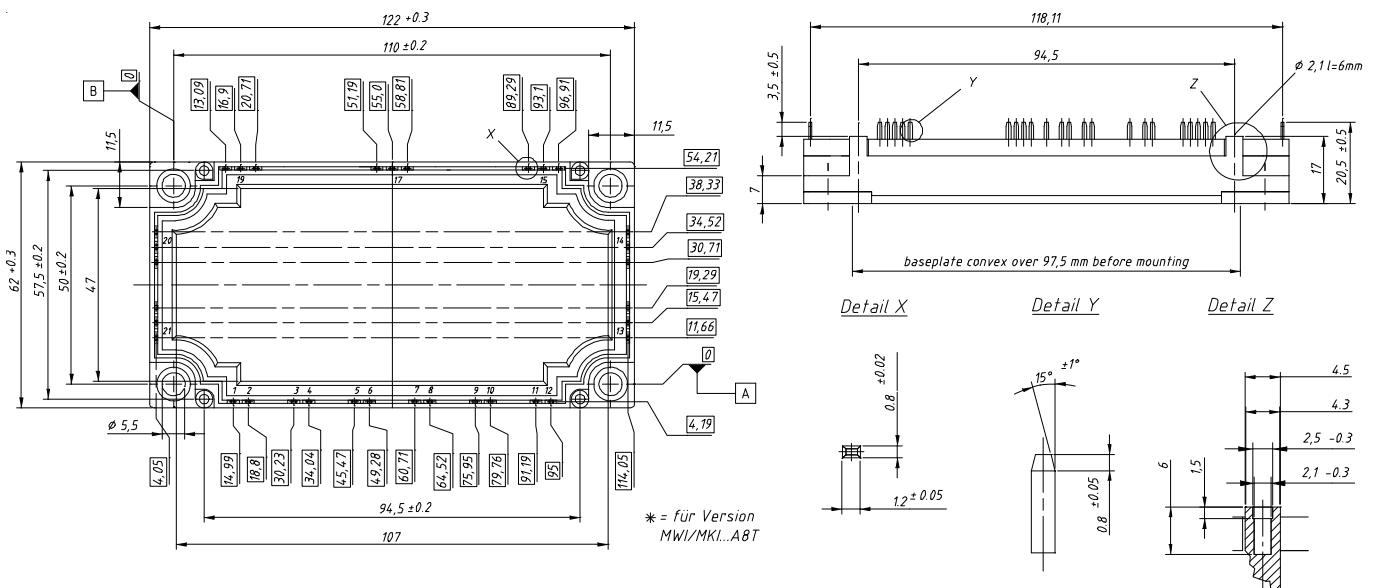

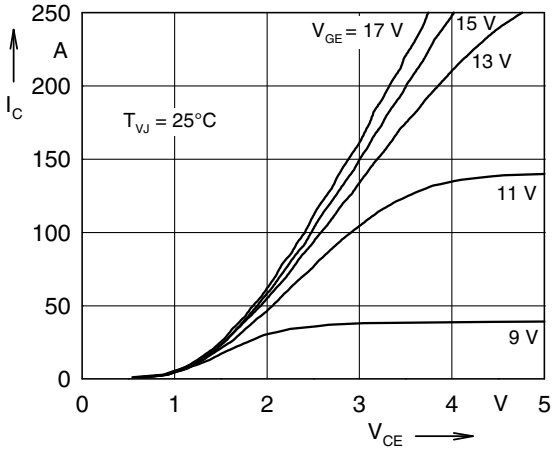

Fig. 1 Typ. output characteristics

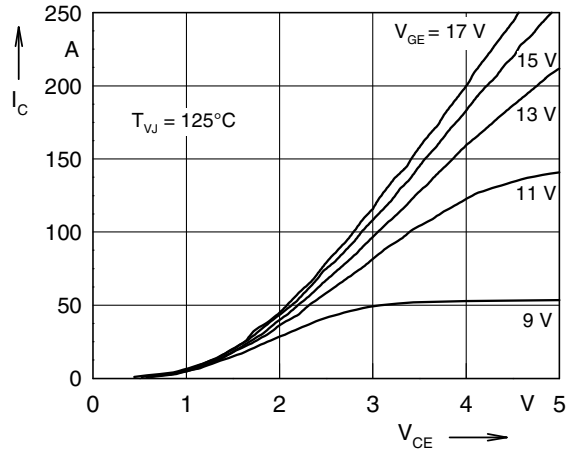

Fig. 2 Typ. output characteristics

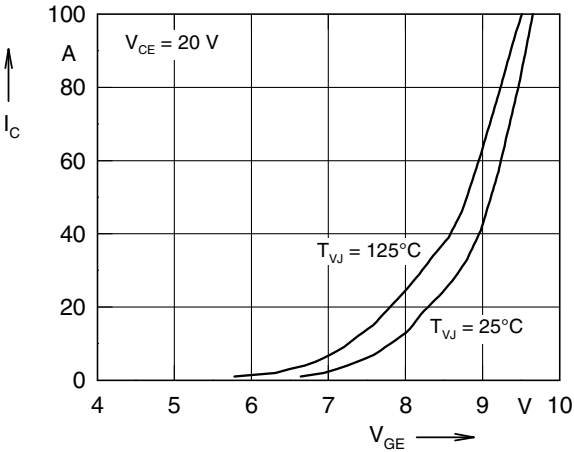

Fig. 3 Typ. transfer characteristics

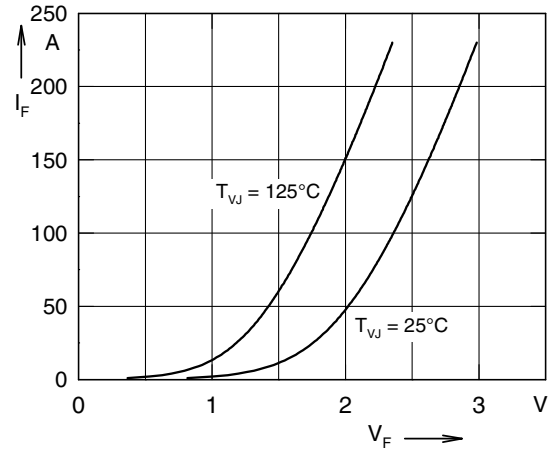

Fig. 4 Typ. forward characteristics of free wheeling diode

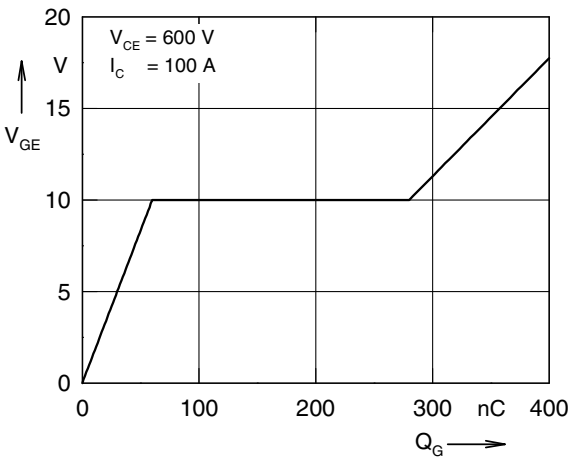

Fig. 5 Typ. turn on gate charge

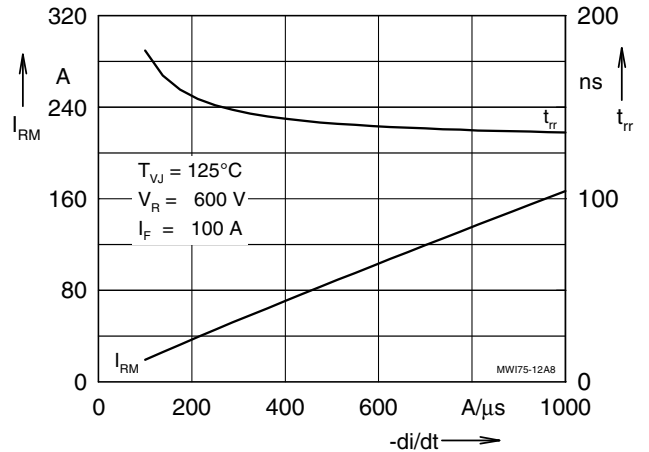

Fig. 6 Typ. turn off characteristics of free wheeling diode

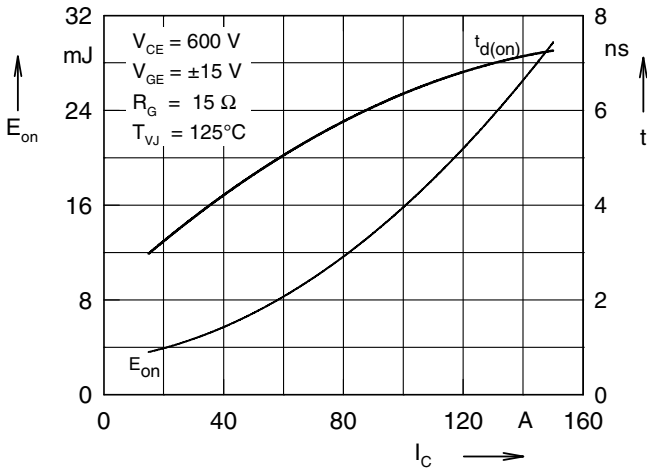

Fig. 7 Typ. turn on energy and switching times versus collector current

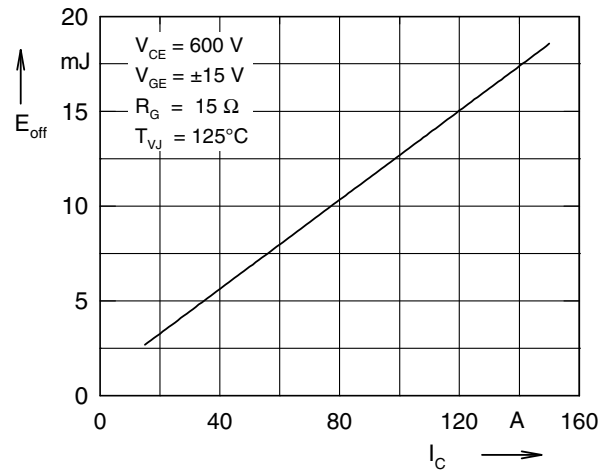

Fig. 8 Typ. turn off energy and switching times versus collector current

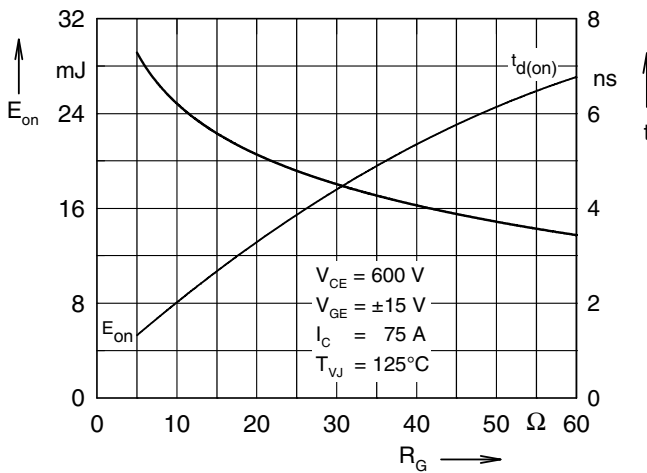

Fig. 9 Typ. turn on energy and switching times versus gate resistor

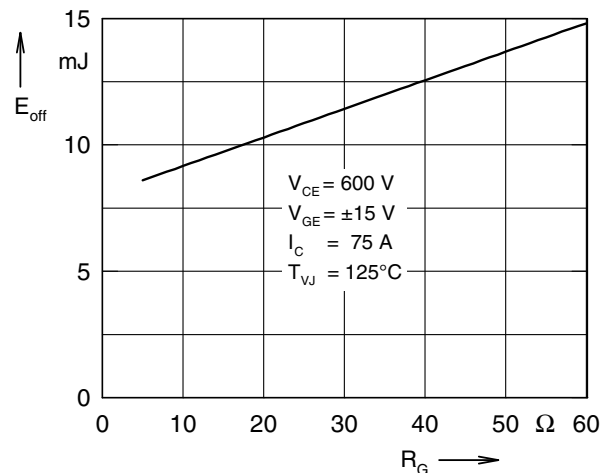

Fig. 10 Typ. turn off energy and switching times versus gate resistor

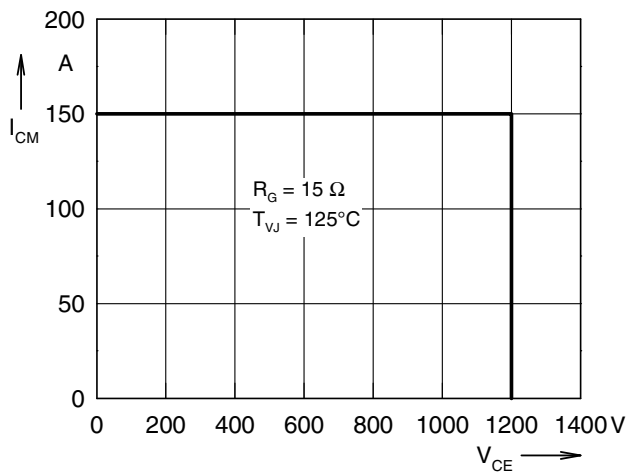

Fig. 11 Reverse biased safe operating area RBSOA

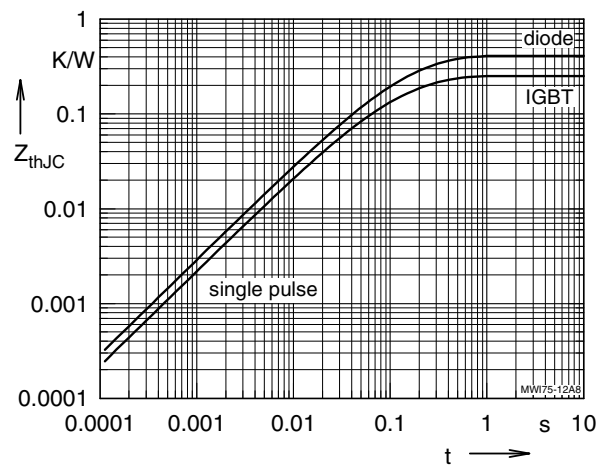

Fig. 12 Typ. transient thermal impedance