

FEATURES

- Isolated PWM feedback with built in compensation**
- Primary side transformer driver for up to 2.5 W output power with 5 V input voltage**
- Regulated adjustable output: 3.3 V to 24 V**
- Up to 80% efficiency**
- 200 kHz to 1 MHz adjustable oscillator**
- Soft start function at power-up**
- Pulse-by-pulse overcurrent protection**
- Thermal shutdown**
- 2500 V rms isolation**
- High common-mode transient immunity: >25 kV/ μ s**
- 16-lead QSOP package**
- High temperature operation: 105°C**

APPLICATIONS

- Power supply startup bias and gate drives**
- Isolated sensor interfaces**
- Process controls**

GENERAL DESCRIPTION

The ADuM3070¹ isolator is a regulated dc-to-dc isolated power supply controller with an internal MOSFET driver. The dc-to-dc controller has an internal isolated PWM feedback from the secondary side based on the iCoupler[®] chip scale transformer technology and complete loop compensation. This eliminates the need to use an optocoupler for feedback and compensates the loop for stability.

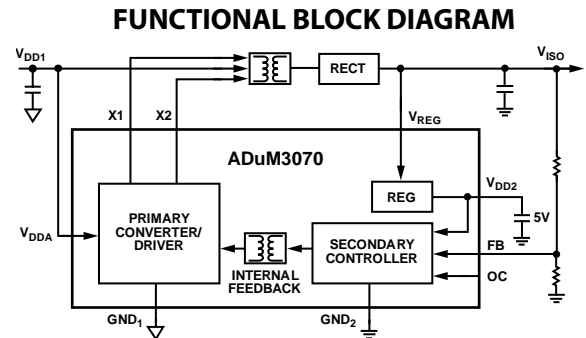

NOTES

1. V_{DD1} IS THE POWER SUPPLY FOR THE PUSH-PULL TRANSFORMER.
2. V_{DDA} IS THE POWER SUPPLY OF SIDE 1 OF THE ADuM3070.

10437-001

Figure 1.

The ADuM3070 isolator provides a more stable output voltage and higher efficiency compared to unregulated isolated dc-to-dc power supplies. The fully integrated feedback and loop compensation in a small QSOP package provides a smaller form factor than any discrete solution. The regulated feedback provides a relatively flat efficiency curve over the full output power range. The ADuM3070 enables a dc-to-dc converter with a 3.3 V to 24 V isolated output voltage range from either a 5.0 V or a 3.3 V input voltage, with an output power of up to 2.5 W.

¹ Protected by U.S. Patents 5,952,849; 6,873,065; and 7,075,329 B2. Other patents are pending.

Rev. 0

Information furnished by Analog Devices is believed to be accurate and reliable. However, no responsibility is assumed by Analog Devices for its use, nor for any infringements of patents or other rights of third parties that may result from its use. Specifications subject to change without notice. No license is granted by implication or otherwise under any patent or patent rights of Analog Devices. Trademarks and registered trademarks are the property of their respective owners.

TABLE OF CONTENTS

Features	1	Pin Configuration and Function Descriptions.....	8
Applications.....	1	Typical Performance Characteristics	9
Functional Block Diagram	1	Applications Information	14
General Description	1	Application Schematics	14
Revision History	2	Transformer Design	15
Specifications.....	3	Transformer Turns Ratio.....	15
Electrical Characteristics—5 V Primary Input Supply/5 V		Transformer ET Constant	15
Secondary Isolated Supply.....	3	Transformer Primary Inductance and Resistance	15
Electrical Characteristics—3.3 V Primary Input Supply/3.3 V		Transformer Isolation Voltage	16
Secondary Isolated Supply.....	3	Switching Frequency.....	16
Electrical Characteristics—5 V Primary Input Supply/3.3 V		Transient Response	16
Secondary Isolated Supply.....	4	Component Selection	16
Electrical Characteristics—5 V Primary Input Supply/15 V		Printed Circuit Board (PCB) Layout	17
Secondary Isolated Supply.....	4	Thermal Analysis	17
Package Characteristics	5	Power Consumption	17
Regulatory Approvals (Pending).....	5	Power Considerations.....	18
Insulation and Safety Related Specifications	5	Insulation Lifetime	18
DIN V VDE V 0884-10 (VDE V 0884-10) Insulation		Outline Dimensions	19
Characteristics	6	Ordering Guide	19
Recommended Operating Conditions	6		
Absolute Maximum Ratings.....	7		
ESD Caution.....	7		

REVISION HISTORY

5/12—Revision 0: Initial Version

SPECIFICATIONS

ELECTRICAL CHARACTERISTICS—5 V PRIMARY INPUT SUPPLY/5 V SECONDARY ISOLATED SUPPLY

$4.5\text{ V} \leq V_{DD1} = V_{DDA} \leq 5.5\text{ V}$, $V_{DD2} = V_{REG} = V_{ISO} = 5.0\text{ V}$, $f_{SW} = 500\text{ kHz}$, all voltages are relative to their respective grounds, see the application schematic in Figure 31. All minimum/maximum specifications apply over the entire recommended operating range, unless otherwise noted. All typical specifications are at $T_A = 25^\circ\text{C}$, $V_{DD1} = V_{DDA} = 5.0\text{ V}$, $V_{DD2} = V_{REG} = V_{ISO} = 5.0\text{ V}$.

Table 1. DC-to-DC Converter Static Specifications

Parameter	Symbol	Min	Typ	Max	Unit	Test Conditions/Comments		
DC-TO-DC CONVERTER SUPPLY								
Isolated Output Voltage	V_{ISO}	4.5	5.0	5.5	V	$I_{ISO} = 0\text{ mA}$, $V_{ISO} = V_{FB} \times (R1 + R2)/R2$		
Feedback Voltage Setpoint	V_{FB}	1.15	1.25	1.37	V	$I_{ISO} = 0\text{ mA}$		
Line Regulation	$V_{ISO(LINE)}$		1	10	mV/V	$I_{ISO} = 50\text{ mA}$, $V_{DD1}^1 = V_{DDA}^2 = 4.5\text{ V to }5.5\text{ V}$		
Load Regulation	$V_{ISO(LOAD)}$		1	2	%	$I_{ISO} = 50\text{ mA to }200\text{ mA}$		
Output Ripple	$V_{ISO(RIP)}$		50		mV p-p	20 MHz bandwidth, $C_{OUT} = 0.1\text{ }\mu\text{F} 47\text{ }\mu\text{F}$, $I_{ISO} = 100\text{ mA}$		
Output Noise	$V_{ISO(NOISE)}$		100		mV p-p	20 MHz bandwidth, $C_{OUT} = 0.1\text{ }\mu\text{F} 47\text{ }\mu\text{F}$, $I_{ISO} = 100\text{ mA}$		
Switching Frequency	f_{SW}		1000			kHz	$R_{OC} = 50\text{ k}\Omega$	
				200			kHz	$R_{OC} = 270\text{ k}\Omega$
			192	318	515	kHz	$V_{OC} = V_{DD2}$ (open-loop)	
I_{DDA} Quiescent	$I_{DDA(Q)}$		4	5	mA			
Switch On Resistance	R_{ON}		0.5		Ω			
Maximum Output Supply Current	$I_{ISO(MAX)}$	400	500		mA	$f \leq 1\text{ MHz}$, $V_{ISO} = 5.0\text{ V}$		
Efficiency at Maximum Output Current			70		%	$I_{ISO} = I_{ISO(MAX)}$, $f \leq 1\text{ MHz}$		

¹ V_{DD1} is the power supply for the push-pull transformer.

² V_{DDA} is the power supply of Side 1 of the ADuM3070.

ELECTRICAL CHARACTERISTICS—3.3 V PRIMARY INPUT SUPPLY/3.3 V SECONDARY ISOLATED SUPPLY

$3.0\text{ V} \leq V_{DD1} = V_{DDA} \leq 3.6\text{ V}$, $V_{DD2} = V_{REG} = V_{ISO} = 3.3\text{ V}$, $f_{SW} = 500\text{ kHz}$, all voltages are relative to their respective grounds, see the application schematic in Figure 31. All minimum/maximum specifications apply over the entire recommended operating range, unless otherwise noted. All typical specifications are at $T_A = 25^\circ\text{C}$, $V_{DD1} = V_{DDA} = 3.3\text{ V}$, $V_{DD2} = V_{REG} = V_{ISO} = 3.3\text{ V}$.

Table 2. DC-to-DC Converter Static Specifications

Parameter	Symbol	Min	Typ	Max	Unit	Test Conditions/Comments		
DC-TO-DC CONVERTER SUPPLY								
Isolated Output Voltage	V_{ISO}	3.0	3.3	3.63	V	$I_{ISO} = 0\text{ mA}$, $V_{ISO} = V_{FB} \times (R1 + R2)/R2$		
Feedback Voltage Setpoint	V_{FB}	1.15	1.25	1.37	V	$I_{ISO} = 0\text{ mA}$		
Line Regulation	$V_{ISO(LINE)}$		1	10	mV/V	$I_{ISO} = 50\text{ mA}$, $V_{DD1}^1 = V_{DDA}^2 = 3.0\text{ V to }3.6\text{ V}$		
Load Regulation	$V_{ISO(LOAD)}$		1	2	%	$I_{ISO} = 50\text{ mA to }200\text{ mA}$		
Output Ripple	$V_{ISO(RIP)}$		50		mV p-p	20 MHz bandwidth, $C_{OUT} = 0.1\text{ }\mu\text{F} 47\text{ }\mu\text{F}$, $I_{ISO} = 100\text{ mA}$		
Output Noise	$V_{ISO(NOISE)}$		100		mV p-p	20 MHz bandwidth, $C_{OUT} = 0.1\text{ }\mu\text{F} 47\text{ }\mu\text{F}$, $I_{ISO} = 100\text{ mA}$		
Switching Frequency	f_{SW}		1000			kHz	$R_{OC} = 50\text{ k}\Omega$	
				200			kHz	$R_{OC} = 270\text{ k}\Omega$
			192	318	515	kHz	$V_{OC} = V_{DD2}$ (open-loop)	
I_{DDA} Quiescent	$I_{DDA(Q)}$		2	3.5	mA			
Switch On Resistance	R_{ON}		0.6		Ω			
Maximum Output Supply Current	$I_{ISO(MAX)}$	250	350		mA	$f \leq 1\text{ MHz}$, $V_{ISO} = 3.3\text{ V}$		
Efficiency at Maximum Output Current			70		%	$I_{ISO} = I_{ISO(MAX)}$, $f \leq 1\text{ MHz}$		

¹ V_{DD1} is the power supply for the push-pull transformer.

² V_{DDA} is the power supply of Side 1 of the ADuM3070.

ELECTRICAL CHARACTERISTICS—5 V PRIMARY INPUT SUPPLY/3.3 V SECONDARY ISOLATED SUPPLY

$4.5\text{ V} \leq V_{DD1} = V_{DDA} \leq 5.5\text{ V}$, $V_{DD2} = V_{REG} = V_{ISO} = 3.3\text{ V}$, $f_{SW} = 500\text{ kHz}$, all voltages are relative to their respective grounds, see the application schematic in Figure 31. All minimum/maximum specifications apply over the entire recommended operating range, unless otherwise noted. All typical specifications are at $T_A = 25^\circ\text{C}$, $V_{DD1} = V_{DDA} = 5.0\text{ V}$, $V_{DD2} = V_{REG} = V_{ISO} = 3.3\text{ V}$.

Table 3. DC-to-DC Converter Static Specifications

Parameter	Symbol	Min	Typ	Max	Unit	Test Conditions/Comments
DC-TO-DC CONVERTER SUPPLY						
Isolated Output Voltage	V_{ISO}	3.0	3.3	3.63	V	$I_{ISO} = 0\text{ mA}$, $V_{ISO} = V_{FB} \times (R1 + R2)/R2$
Feedback Voltage Setpoint	V_{FB}	1.15	1.25	1.37	V	$I_{ISO} = 0\text{ mA}$
Line Regulation	$V_{ISO(LINE)}$	1	10		mV/V	$I_{ISO} = 50\text{ mA}$, $V_{DD1}^1 = V_{DDA}^2 = 4.5\text{ V to }5.5\text{ V}$
Load Regulation	$V_{ISO(LOAD)}$	1	2		%	$I_{ISO} = 50\text{ mA to }200\text{ mA}$
Output Ripple	$V_{ISO(RIP)}$	50			mV p-p	20 MHz bandwidth, $C_{OUT} = 0.1\text{ }\mu\text{F} 47\text{ }\mu\text{F}$, $I_{ISO} = 100\text{ mA}$
Output Noise	$V_{ISO(NOISE)}$	100			mV p-p	20 MHz bandwidth, $C_{OUT} = 0.1\text{ }\mu\text{F} 47\text{ }\mu\text{F}$, $I_{ISO} = 100\text{ mA}$
Switching Frequency	f_{SW}	209	1000			$R_{OC} = 50\text{ k}\Omega$
			200			$R_{OC} = 270\text{ k}\Omega$
			318	515		$V_{OC} = V_{DD2}$ (open-loop)
I_{DDA} Quiescent	$I_{DDA(Q)}$		3.5	5	mA	
Switch On Resistance	R_{ON}		0.5		Ω	
Maximum Output Supply Current	$I_{ISO(MAX)}$	400	500		mA	$f \leq 1\text{ MHz}$, $V_{ISO} = 3.3\text{ V}$
Efficiency at Maximum Output Current			70		%	$I_{ISO} = I_{ISO(MAX)}$, $f \leq 1\text{ MHz}$

¹ V_{DD1} is the power supply for the push-pull transformer.

² V_{DDA} is the power supply of Side 1 of the ADuM3070.

ELECTRICAL CHARACTERISTICS—5 V PRIMARY INPUT SUPPLY/15 V SECONDARY ISOLATED SUPPLY

$4.5\text{ V} \leq V_{DD1} = V_{DDA} \leq 5.5\text{ V}$, $V_{REG} = V_{ISO} = 15\text{ V}$, $V_{DD2} = 5.0\text{ V}$, $f_{SW} = 500\text{ kHz}$, all voltages are relative to their respective grounds, see the application schematic in Figure 32. All minimum/maximum specifications apply over the entire recommended operating range, unless otherwise noted. All typical specifications are at $T_A = 25^\circ\text{C}$, $V_{DD1} = V_{DDA} = 5.0\text{ V}$, $V_{REG} = V_{ISO} = 15\text{ V}$, $V_{DD2} = 5.0\text{ V}$.

Table 4. DC-to-DC Converter Static Specifications

Parameter	Symbol	Min	Typ	Max	Unit	Test Conditions/Comments
DC-TO-DC CONVERTER SUPPLY						
Isolated Output Voltage	V_{ISO}	13.8	15.0	16.5	V	$I_{ISO} = 0\text{ mA}$, $V_{ISO} = V_{FB} \times (R1 + R2)/R2$
Feedback Voltage Setpoint	V_{FB}	1.15	1.25	1.37	V	$I_{ISO} = 0\text{ mA}$
V_{DD2} Linear Regulator Voltage	V_{DD2}	4.5	5.0	5.48	V	$V_{REG} = 7\text{ V to }15\text{ V}$, $I_{DD2} = 0\text{ mA to }50\text{ mA}$
Dropout Voltage	V_{DD2DO}		0.5	1.5	V	$I_{DD2} = 50\text{ mA}$
Line Regulation	$V_{ISO(LINE)}$	1	10		mV/V	$I_{ISO} = 50\text{ mA}$, $V_{DD1}^1 = V_{DDA}^2 = 4.5\text{ V to }5.5\text{ V}$
Load Regulation	$V_{ISO(LOAD)}$	1	3		%	$I_{ISO} = 20\text{ mA to }100\text{ mA}$
Output Ripple	$V_{ISO(RIP)}$	200			mV p-p	20 MHz bandwidth, $C_{OUT} = 0.1\text{ }\mu\text{F} 47\text{ }\mu\text{F}$, $I_{ISO} = 100\text{ mA}$
Output Noise	$V_{ISO(NOISE)}$	500			mV p-p	20 MHz bandwidth, $C_{OUT} = 0.1\text{ }\mu\text{F} 47\text{ }\mu\text{F}$, $I_{ISO} = 100\text{ mA}$
Switching Frequency	f_{SW}	192	1000			$R_{OC} = 50\text{ k}\Omega$
			200			$R_{OC} = 270\text{ k}\Omega$
			318	515		$V_{OC} = V_{DD2}$ (open-loop)
I_{DDA} Quiescent	$I_{DDA(Q)}$		3.5	5	mA	
Switch On Resistance	R_{ON}		0.5		Ω	
Maximum Output Supply Current	$I_{ISO(MAX)}$	100	140		mA	$f \leq 1\text{ MHz}$, $V_{ISO} = 15.0\text{ V}$
Efficiency at Maximum Output Current			70		%	$I_{ISO} = I_{ISO(MAX)}$, $f \leq 1\text{ MHz}$

¹ V_{DD1} is the power supply for the push-pull transformer.

² V_{DDA} is the power supply of Side 1 of the ADuM3070.

PACKAGE CHARACTERISTICS

Table 5.

Parameter	Symbol	Min	Typ	Max	Unit	Test Conditions/Comments
RESISTANCE Input to Output ¹	R _{I-O}		10 ¹²		Ω	
CAPACITANCE Input to Output ¹	C _{I-O}		2.2		pF	f = 1 MHz
THERMAL IC Junction-to-Ambient Thermal Resistance ²	θ _{JA}		76		°C/W	
Thermal Shutdown Threshold	T _{SD}		150		°C	T _J rising
Hysteresis	T _{SD-HYS}		20		°C	

¹ The device is considered a 2-terminal device: Pin 1 to Pin 8 is shorted together, and Pin 9 to Pin 16 is shorted together.

² The thermocouple is located at the center of the package underside.

REGULATORY APPROVALS (PENDING)

Table 6.

UL	CSA	VDE
Recognized under the UL 1577 Component Recognition Program ¹ Single Protection, 2500 V rms Isolation Voltage File E214100	Approved under CSA Component Acceptance Notice #5A Basic insulation per CSA 60950-1-03 and IEC 60950-1, 400 V rms (848 V peak) maximum working voltage File 205078	Certified according to DIN V VDE V 0884-10 (VDE V 0884-10):2006-12 ² Reinforced insulation, 560 V peak File 2471900-4880-0001

¹ In accordance with UL 1577, each ADuM3070 is proof tested by applying an insulation test voltage of ≥3000 V rms for 1 sec (current leakage detection limit = 10 μA).

² In accordance with DIN V VDE V 0884-10, each ADuM3070 is proof tested by applying an insulation test voltage of ≥1050 V peak for 1 sec (partial discharge detection limit = 5 pC). The asterisk (*) marking branded on the component designates DIN V VDE V 0884-10 approval.

INSULATION AND SAFETY RELATED SPECIFICATIONS

Table 7.

Parameter	Symbol	Value	Unit	Test Conditions/Comments
Rated Dielectric Insulation Voltage		2500	V rms	1-minute duration
Minimum External Air Gap (Clearance)	L(I01)	>3.8	mm	Measured from input terminals to output terminals along the printed circuit board (PCB) seating plane
Minimum External Tracking (Creepage)	L(I02)	>3.1	mm	Measured from input terminals to output terminals, shortest distance path along body
Minimum Internal Gap (Internal Clearance)		0.017 min	mm	Distance through insulation
Tracking Resistance (Comparative Tracking Index)	CTI	>400	V	DIN IEC 112/VDE 0303 Part 1
Isolation Group		II		Material Group (DIN VDE 0110, 1/89, Table 1)

DIN V VDE V 0884-10 (VDE V 0884-10) INSULATION CHARACTERISTICS

These isolators are suitable for reinforced electrical isolation only within the safety limit data. Protective circuits ensure maintenance of the safety data. The asterisk (*) marking on packages denotes DIN V VDE V 0884-10 approval.

Table 8.

Parameter	Test Conditions/Comments	Symbol	Characteristic	Unit
Installation Classification per DIN VDE 0110 For Rated Mains Voltage ≤ 150 V rms For Rated Mains Voltage ≤ 300 V rms For Rated Mains Voltage ≤ 400 V rms			I to IV I to III I to II	
Climatic Classification			40/105/21	
Pollution Degree per DIN VDE 0110, Table 1			2	
Maximum Working Insulation Voltage		V _{IORM}	560	V _{PEAK}
Input-to-Output Test Voltage, Method b1	V _{IORM} × 1.875 = V _{pd(m)} , 100% production test, t _{ini} = t _m = 1 sec, partial discharge < 5 pC	V _{pd(m)}	1050	V _{PEAK}
Input-to-Output Test Voltage, Method a After Environmental Tests Subgroup 1	V _{IORM} × 1.5 = V _{pd(m)} , t _{ini} = 60 sec, t _m = 10 sec, partial discharge < 5 pC	V _{pd(m)}	840	V _{PEAK}
After Input and/or Safety Test Subgroup 2 and Subgroup 3	V _{IORM} × 1.2 = V _{pd(m)} , t _{ini} = 60 sec, t _m = 10 sec, partial discharge < 5 pC	V _{pd(m)}	672	V _{PEAK}
Highest Allowable Overvoltage		V _{IOTM}	3500	V _{PEAK}
Withstand Isolation Voltage	1 minute withstand rating	V _{ISO}	2500	V _{RMS}
Surge Isolation Voltage	V _{PEAK} = 10 kV, 1.2 μs rise time, 50 μs, 50% fall time	V _{IOSM}	6000	V _{PEAK}
Safety Limiting Values	Maximum value allowed in the event of a failure (see Figure 2)			
Case Temperature		T _S	150	°C
Side 1, Side 2 P _{VDDA} , P _{VREG} Power Dissipation		P _{VDDA} , P _{VREG}	1.65	W
Insulation Resistance at T _S	V _{IO} = 500 V	R _S	>10 ⁹	Ω

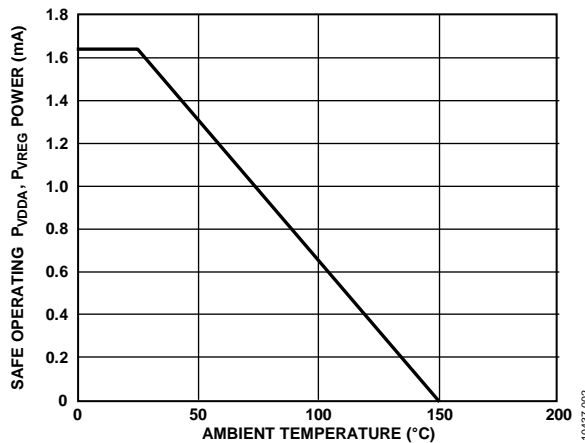

Figure 2. Thermal Derating Curve, Dependence of Safety Limiting Values on Ambient Temperature, per DIN V VDE V 0884-10

RECOMMENDED OPERATING CONDITIONS

Table 9.

Parameter	Symbol	Min	Max	Unit
TEMPERATURE				
Operating Temperature	T _A	-40	+105	°C
LOAD				
Minimum Load	I _{ISO (MIN)}	10		mA

ABSOLUTE MAXIMUM RATINGS

$T_A = 25^\circ\text{C}$, unless otherwise noted.

Table 10.

Parameter	Rating
Storage Temperature Range (T_{ST})	-55°C to $+150^\circ\text{C}$
Ambient Operating Temperature Range (T_A)	-40°C to $+105^\circ\text{C}$
Supply Voltages	
V_{DDA} , V_{DD2} ^{1,2}	-0.5 V to $+7.0\text{ V}$
V_{REG} , X1, X2 ¹	-0.5 V to $+20.0\text{ V}$
Common-Mode Transients ³	$-100\text{ kV}/\mu\text{s}$ to $+100\text{ kV}/\mu\text{s}$

¹ All voltages are relative to their respective ground.

² V_{DD1} is the power supply for the push-pull transformer, and V_{DDA} is the power supply of Side 1 of the ADuM3070.

³ Refers to common-mode transients across the insulation barrier. Common-mode transients exceeding the absolute maximum ratings may cause latch-up or permanent damage.

Stresses above those listed under Absolute Maximum Ratings may cause permanent damage to the device. This is a stress rating only; functional operation of the device at these or any other conditions above those indicated in the operational section of this specification is not implied. Exposure to absolute maximum rating conditions for extended periods may affect device reliability.

Table 11. Maximum Continuous Working Voltage Supporting 50-Year Minimum Lifetime¹

Parameter	Max	Unit	Applicable Certification
AC Voltage			
Bipolar Waveform	565	V peak	50-year minimum lifetime, all certifications
Unipolar Waveform			
Basic Insulation	848	V peak	Working voltage per IEC 60950-1
DC Voltage			
Basic Insulation	848	V peak	Working voltage per IEC 60950-1

¹ Refers to the continuous voltage magnitude imposed across the isolation barrier. See the Insulation Lifetime section for more information.

ESD CAUTION



ESD (electrostatic discharge) sensitive device. Charged devices and circuit boards can discharge without detection. Although this product features patented or proprietary protection circuitry, damage may occur on devices subjected to high energy ESD. Therefore, proper ESD precautions should be taken to avoid performance degradation or loss of functionality.

PIN CONFIGURATION AND FUNCTION DESCRIPTIONS

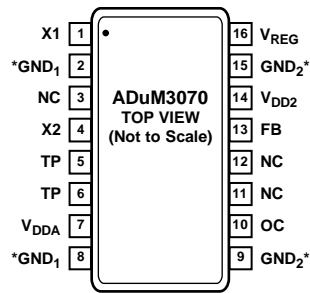

*PIN 2 AND PIN 8 ARE INTERNALLY CONNECTED, AND CONNECTING BOTH TO GND₁ IS RECOMMENDED. PIN 9 AND PIN 15 ARE INTERNALLY CONNECTED, AND CONNECTING BOTH TO GND₂ IS RECOMMENDED.

NOTES

1. NC = NO CONNECT. DO NOT CONNECT TO THIS PIN.
2. TP = TEST POINT. DO NOT CONNECT TO THIS PIN.

10437-003

Figure 3. Pin Configuration

See Application Note [AN-1109](#) for specific layout guidelines.

Table 12. Pin Function Descriptions

Pin No.	Mnemonic	Description
1	X1	Transformer Driver Output 1.
2, 8	GND ₁	Ground Reference for Primary Side.
3, 11, 12	NC	No Connect. Do not connect to this pin.
5, 6	TP	Test Point. Do not connect to this pin.
4	X2	Transformer Driver Output 2.
7	V _{DDA}	Primary Supply Voltage 3.0 V to 5.5 V. Connect to V _{DD1} . Connect a 0.1 μF bypass capacitor from V _{DDA} to GND ₁ .
9, 15	GND ₂	Ground Reference for Secondary Side.
10	OC	Oscillator Control Pin. When OC = logic high = V _{DD2} , the secondary controller runs open-loop. To regulate the output voltage, connect a resistor between the OC pin and GND ₂ , and the secondary controller runs at a frequency of 200 kHz to 1 MHz, as programmed by the resistor value.
13	FB	Feedback Input from the Secondary Output Voltage V _{ISO} . Use a resistor divider from V _{ISO} to the FB pin to make the V _{FB} voltage equal to the 1.25 V internal reference level using the $V_{ISO} = V_{FB} \times (R1 + R2)/R2$ formula. The resistor divider is required even in open-loop mode to provide soft start.
14	V _{DD2}	Internal Supply Voltage Pin for the Secondary Side Controller. When a sufficient external voltage is supplied to V _{REG} , the internal regulator regulates the V _{DD2} pin to 5.0 V. Otherwise, V _{DD2} should be in the 3.0 V to 5.5 V range. Connect a 0.1 μF bypass capacitor from V _{DD2} to GND ₂ .
16	V _{REG}	Input of the Internal Regulator to Power the Secondary Side Controller. V _{REG} should be in the 5.5 V to 15 V range to regulate the V _{DD2} output to 5.0 V.

TYPICAL PERFORMANCE CHARACTERISTICS

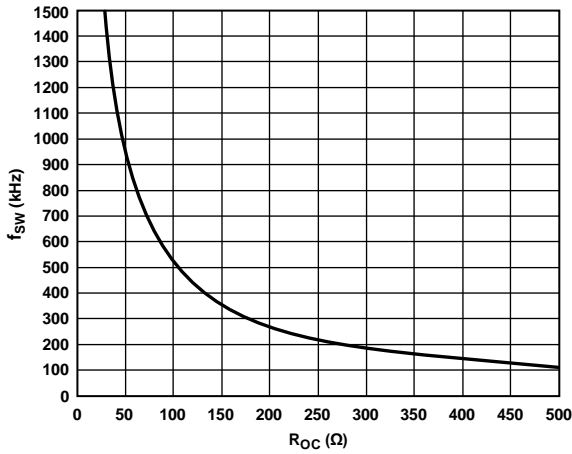

Figure 4. Switching Frequency (f_{sw}) vs. R_{oc} Resistance

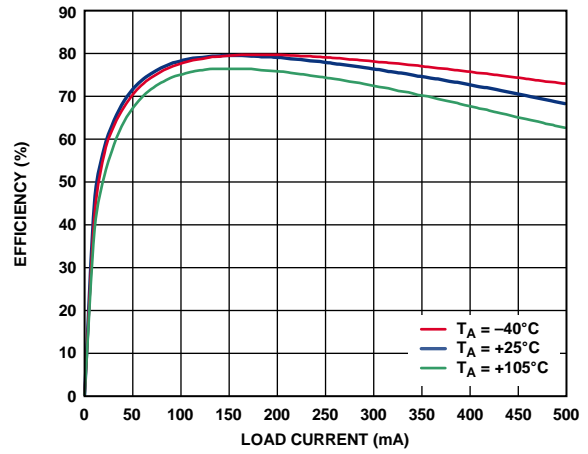

Figure 7. 5 V In to 5 V Out Efficiency over Temperature with 1:2 Coilcraft Transformer (JA4631-BL) at 500 kHz f_{sw}

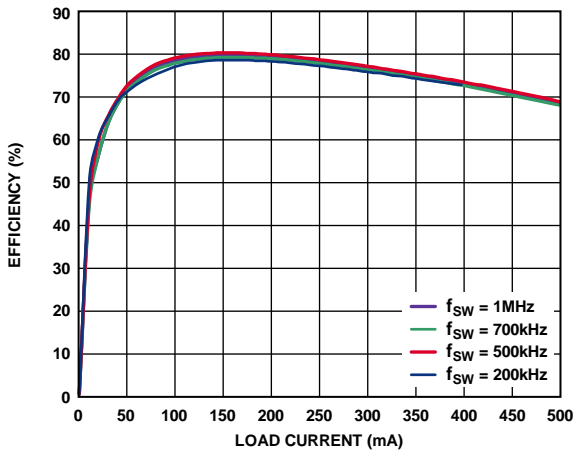

Figure 5. Typical Efficiency at 5 V In to 5 V Out at Various Switching Frequencies with 1:2 Coilcraft Transformer (JA4631-BL)

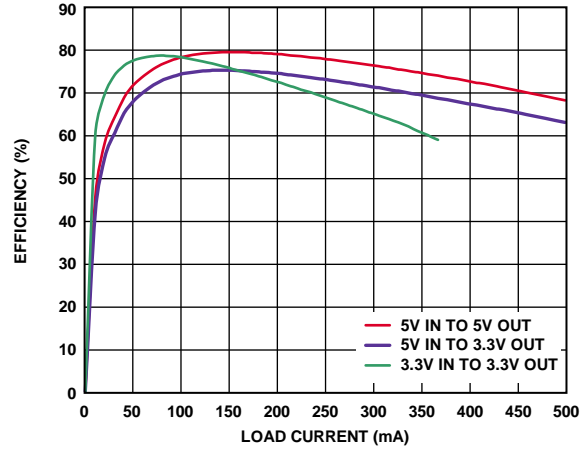

Figure 8. Single-Supply Efficiency with 1:2 Coilcraft Transformer (JA4631-BL) at 500 kHz f_{sw}

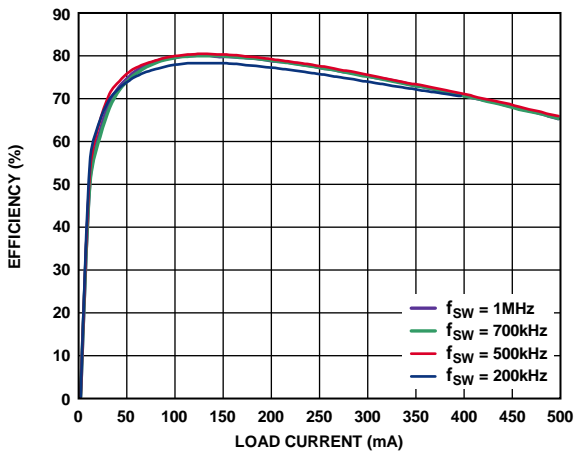

Figure 6. Typical Efficiency at 5 V In to 5 V Out at Various Switching Frequencies with 1:2 Halo Transformer (TGSAD-260V6LF)

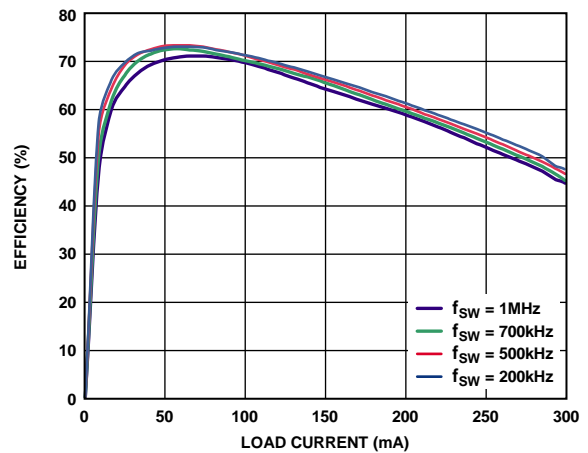

Figure 9. Typical Efficiency at 3.3 V In to 5 V Out at Various Switching Frequencies with 1:3 Halo Transformer (TGSAD-290V6LF)

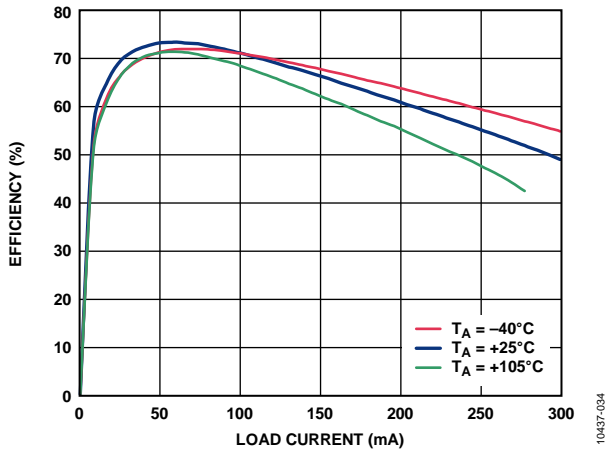

Figure 10. Typical Efficiency at 3.3 V In to 5 V Out over Temperature with 1:3 Halo Transformer (TGSAD-290V6LF) at 500 kHz f_{sw}

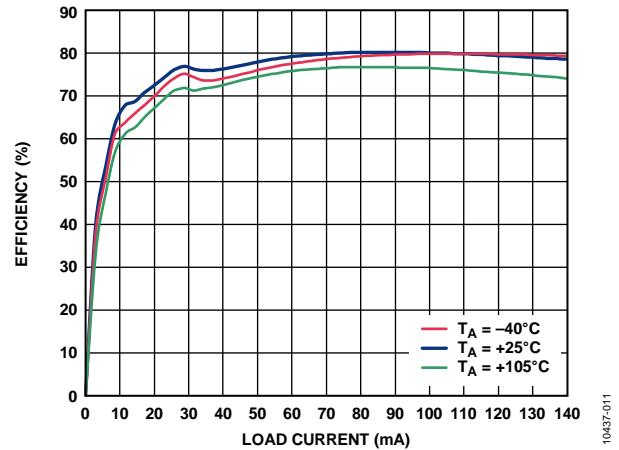

Figure 13. 5 V In to 15 V Out Efficiency over Temperature with 1:3 Coilcraft Transformer (JA4650-BL) at 500 kHz f_{sw}

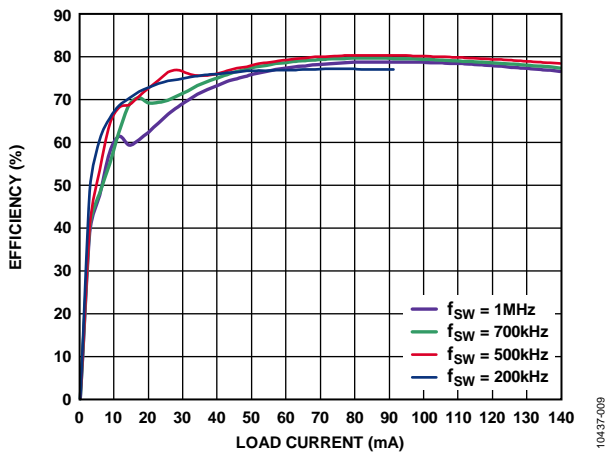

Figure 11. 5 V In to 15 V Out Efficiency at Various Switching Frequencies with 1:3 Coilcraft Transformer (JA4650-BL)

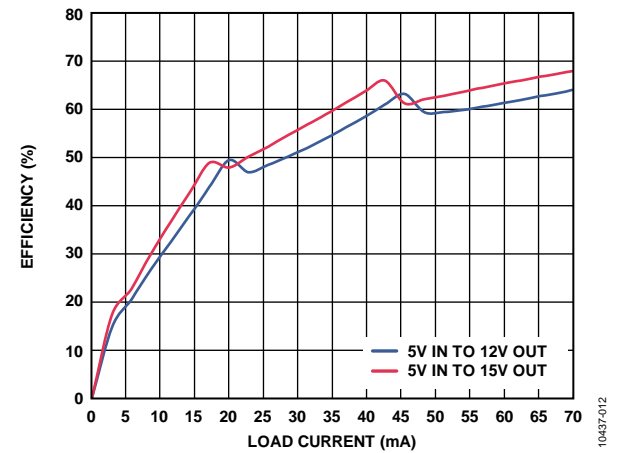

Figure 14. Double-Supply Efficiency with 1:5 Coilcraft Transformer (KA4976-AL) at 500 kHz f_{sw}

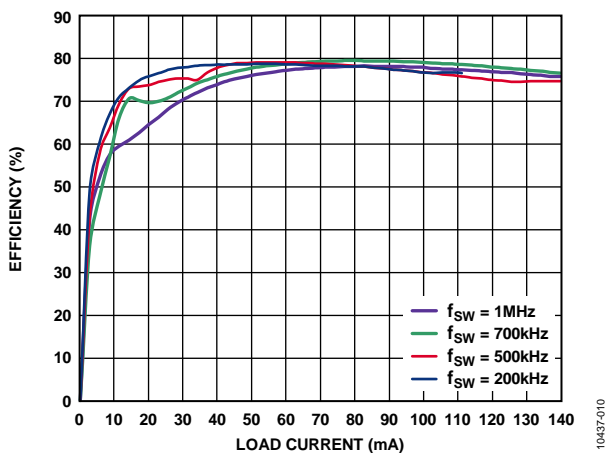

Figure 12. 5 V In to 15 V Out Efficiency at Various Switching Frequencies with 1:3 Halo Transformer (TGSAD-290V6LF)

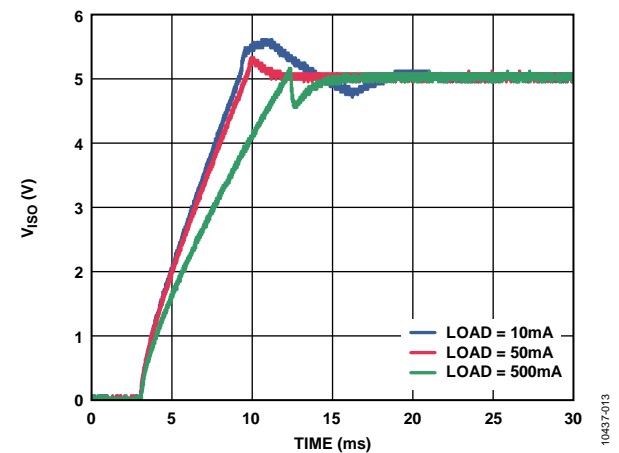

Figure 15. Typical V_{iso} Startup at 5 V In to 5 V Out with 10 mA, 50 mA, and 500 mA Output Load

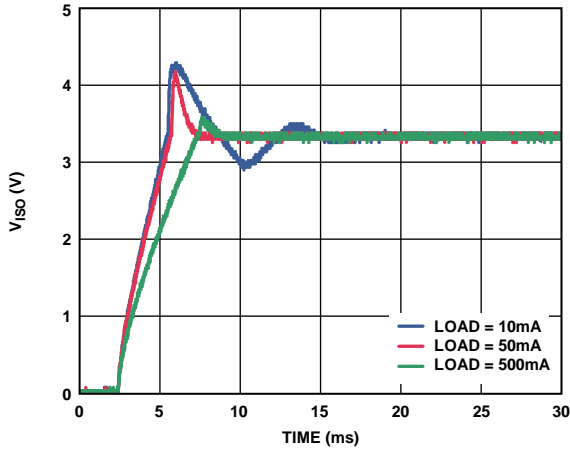

Figure 16. Typical V_{ISO} Startup at 5 V In to 3.3 V Out with 10 mA, 50 mA, and 500 mA Output Load

10437-014

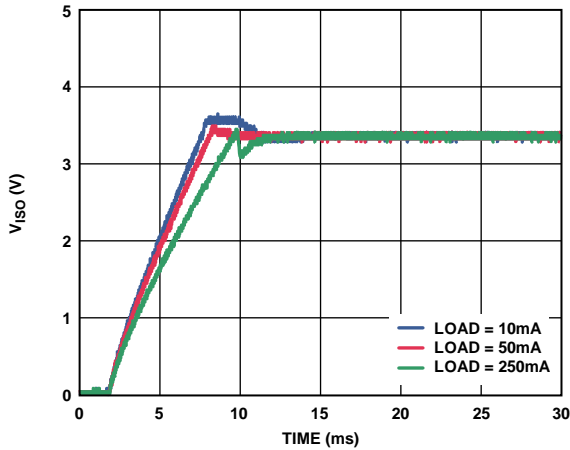

Figure 17. Typical V_{ISO} Startup at 3.3 V In to 3.3 V Out with 10 mA, 50 mA, and 250 mA Output Load

10437-015

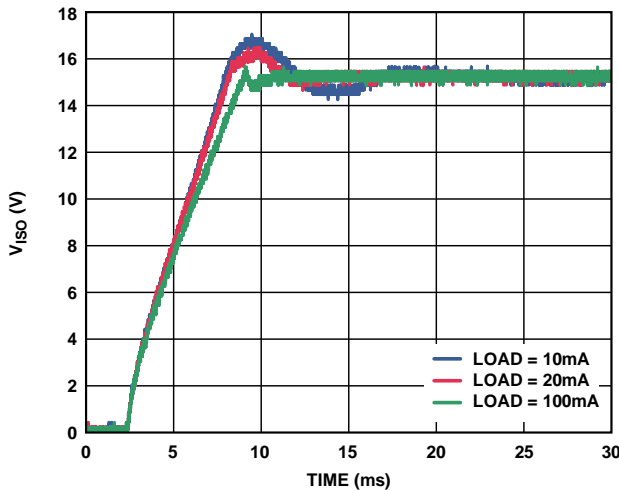

Figure 18. Typical V_{ISO} Startup at 5 V In to 15 V Out with 10 mA, 20 mA, and 100 mA Output Load

10437-016

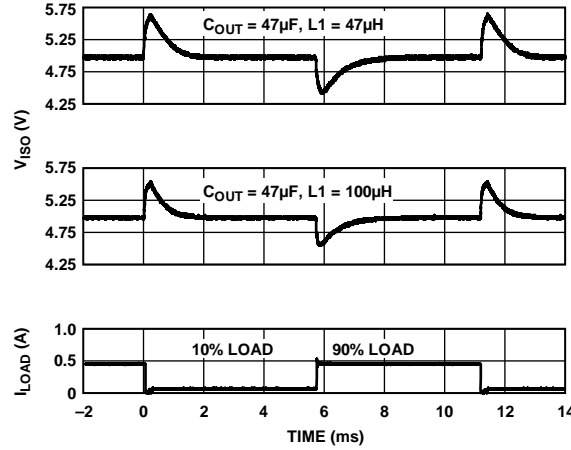

Figure 19. Typical V_{ISO} Load Transient Response, 5 V In to 5 V Out at 10% to 90% of 500 mA Load at 500 kHz f_{SW}

10437-017

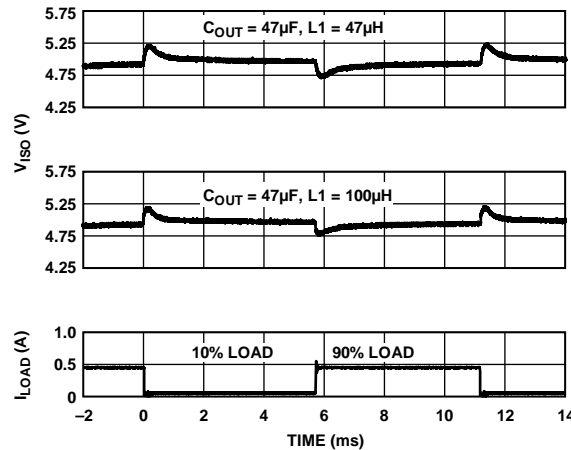

Figure 20. Typical V_{ISO} Load Transient Response, 5 V In to 5 V Out at 10% to 90% of 500 mA Load at 500 kHz f_{SW} with 0.1 μ F Feedback Capacitor

10437-035

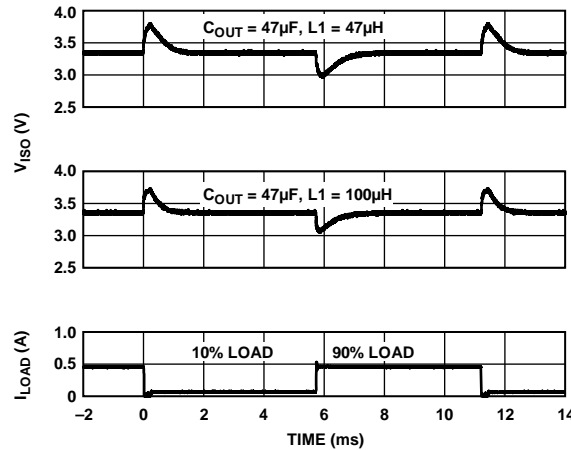

Figure 21. Typical V_{ISO} Load Transient Load Response, 5 V In to 3.3 V Out at 10% to 90% Load of 500 mA Load at 500 kHz f_{SW}

10437-018

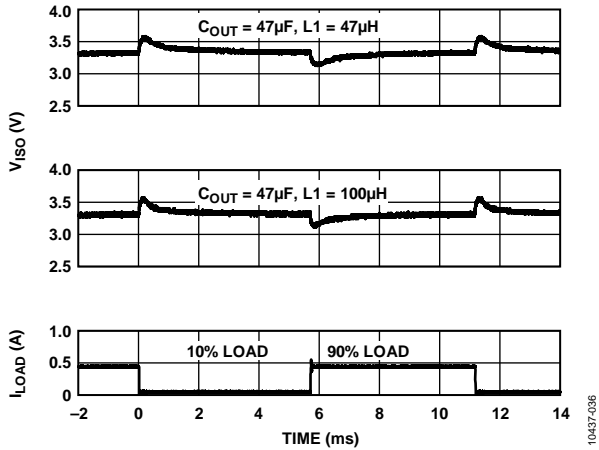

Figure 22. Typical V_{ISO} Load Transient Load Response, 5 V In to 3.3 V Out at 10% to 90% Load of 500 mA Load at 500 kHz f_{sw} with 0.1 μ F Feedback Capacitor

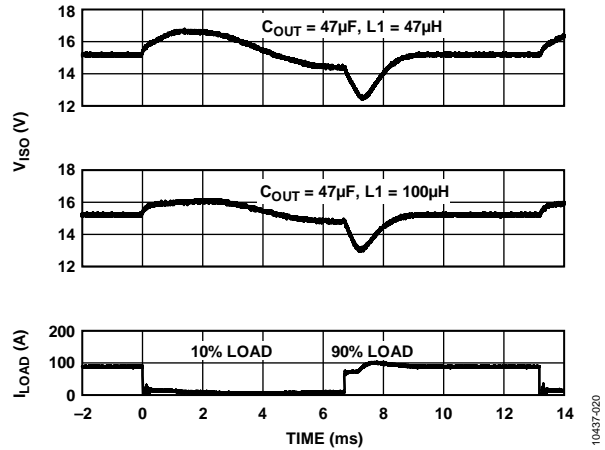

Figure 25. Typical V_{ISO} Load Transient Response, 5 V In to 15 V Out at 10% to 90% of 100 mA Load at 500 kHz f_{sw}

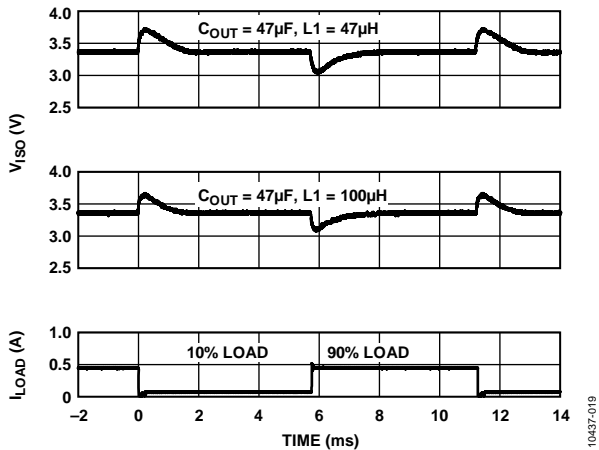

Figure 23. Typical V_{ISO} Load Transient Response, 3.3 V In to 3.3 V Out at 10% to 90% of 250 mA Load at 500 kHz f_{sw}

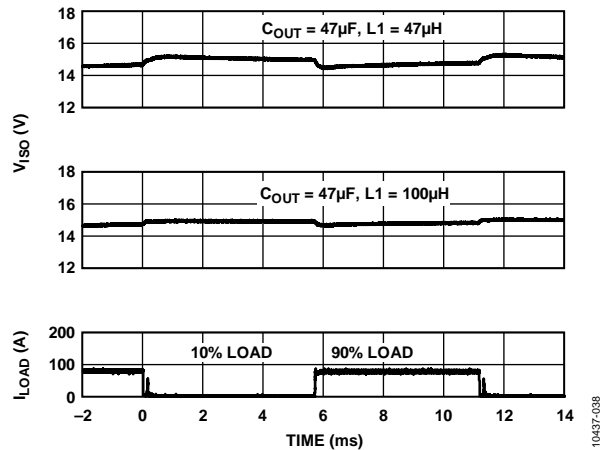

Figure 26. Typical V_{ISO} Load Transient Response, 5 V In to 15 V Out at 10% to 90% of 100 mA Load at 500 kHz f_{sw} with 0.1 μ F Feedback Capacitor

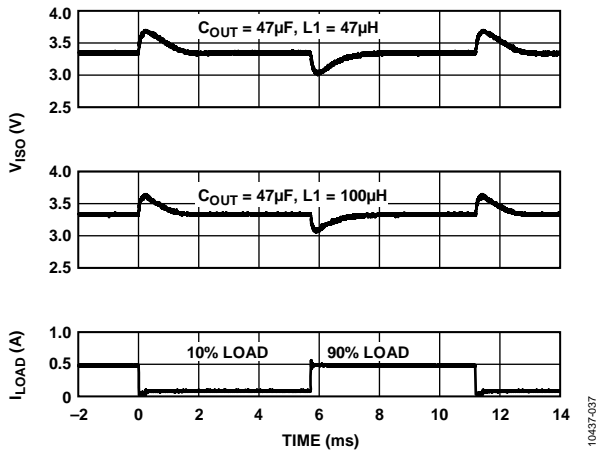

Figure 24. Typical V_{ISO} Load Transient Response, 3.3 V In to 3.3 V Out at 10% to 90% of 250 mA Load at 500 kHz f_{sw} with 0.1 μ F Feedback Capacitor

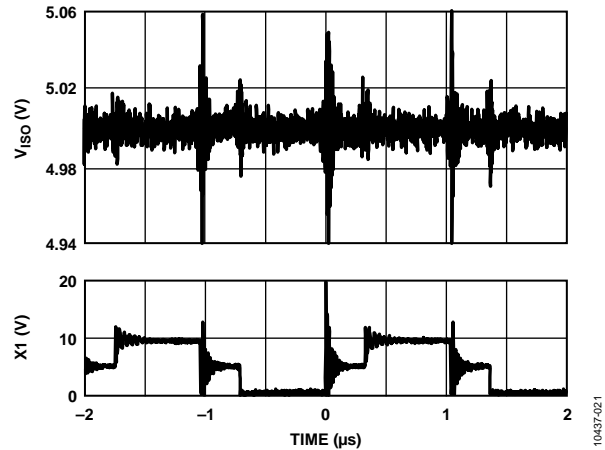

Figure 27. Typical V_{ISO} Output Ripple, 5 V In to 5 V Out at 500 mA Load at 500 kHz f_{sw}

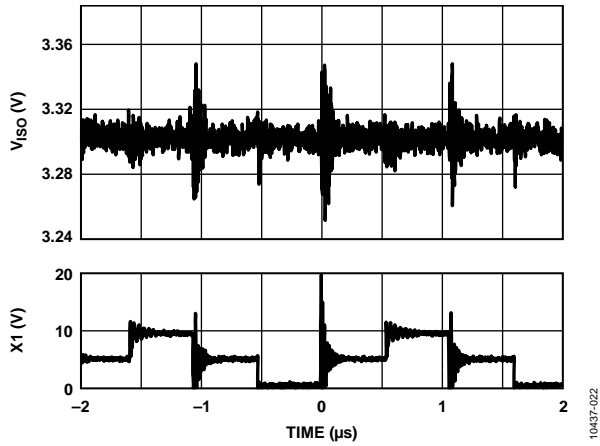

Figure 28. Typical V_{ISO} Output Ripple, 5 V In to 3.3 V Out at 500 mA Load at 500 kHz f_{sw}

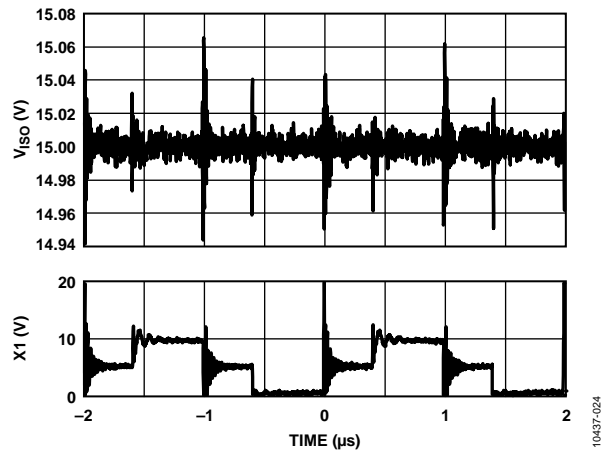

Figure 30. Typical V_{ISO} Output Ripple, 5 V In to 15 V Out at 100 mA Load at 500 kHz f_{sw}

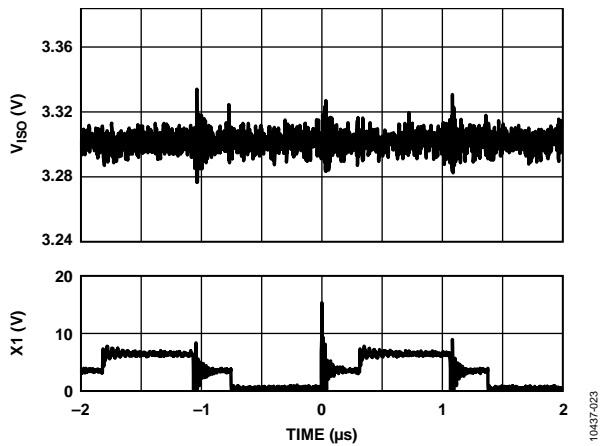

Figure 29. Typical V_{ISO} Output Ripple, 3.3 V In to 3.3 V Out at 250 mA Load at 500 kHz f_{sw}

APPLICATIONS INFORMATION

The dc-to-dc converter section of the ADuM3070 uses a secondary side controller architecture with isolated pulse-width modulation (PWM) feedback. V_{DD1} power is supplied to an oscillating circuit that switches current to the primary side of an external power transformer using internal push-pull switches at the X1 and X2 pins. Power transferred to the secondary side of the transformer is full-wave rectified with external Schottky diodes (D1 and D2), filtered with the L1 inductor and C_{OUT} capacitor, and regulated to the isolated power supply voltage from 3.3 V to 15 V. The secondary (V_{ISO}) side controller regulates the output by using a feedback voltage V_{FB} from a resistor divider on the output and creating a PWM control signal that is sent to the primary (V_{CC}) side by a dedicated iCoupler data channel labeled V_{FB}. The primary side PWM converter varies the duty cycle of the X1 and X2 switches to modulate the oscillator circuit and control the power being sent to the secondary side. This feedback allows for significantly higher power and efficiency.

The ADuM3070 implements undervoltage lockout (UVLO) with hysteresis on the V_{DD1} power input. This feature ensures that the converter does not enter oscillation due to noisy input power or slow power-on ramp rates.

A minimum load current of 10 mA is recommended to ensure optimum load regulation. Smaller loads can generate excess noise on the output because of short or erratic PWM pulses. Excess noise generated from smaller loads can cause regulation problems, in some circumstances.

APPLICATION SCHEMATICS

The ADuM3070 has three main application schematics, as shown in Figure 31 to Figure 33. Figure 31 has a center-tapped secondary and two Schottky diodes providing full wave rectification for a single output, typically for power supplies of 3.3 V, 5 V, 12 V, and 15 V. For single supplies when V_{ISO} = 3.3 V or V_{ISO} = 5 V, see the note in Figure 31 about connecting together V_{REG}, V_{DD2}, and V_{ISO}. Figure 32 is a voltage doubling circuit that can be used for a single supply whose output exceeds 15 V, which is the largest supply that can be connected to the regulator input, V_{REG} (Pin 16), of the part. With Figure 32, the output voltage can be as high as 24 V and the V_{REG} pin is only about 12 V. When using the circuit shown in Figure 32, to obtain an output voltage lower than 10 V (for example, V_{DD1} = 3.3 V, V_{ISO} = 5 V), connect V_{REG} to V_{ISO} directly. Figure 33, which also uses a voltage doubling secondary circuit, is shown as an example of a coarsely regulated, positive power supply and an unregulated, negative power supply for outputs of approximately ±5 V, ±12 V, and ±15 V. For any circuit in Figure 31, Figure 32, or Figure 33, the isolated output voltage (V_{ISO}) can be set using the voltage dividers, R1 and R2 (values 1 kΩ to 100 kΩ), using the following equation:

$$V_{ISO} = V_{FB} \times \frac{R1 + R2}{R2}$$

where V_{FB} is the internal feedback voltage, which is approximately 1.25 V.

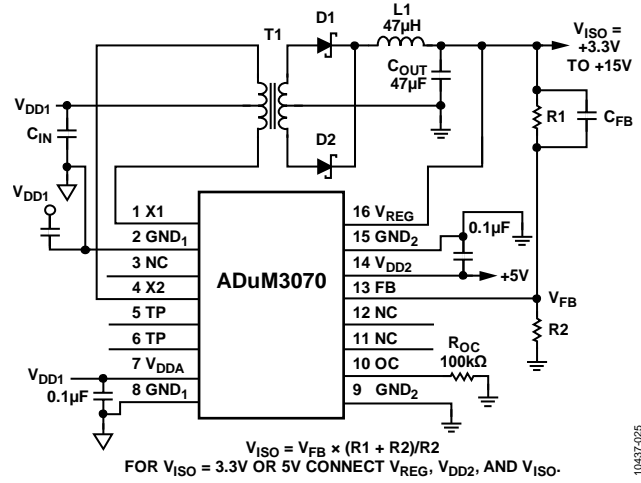

Figure 31. Single Power Supply

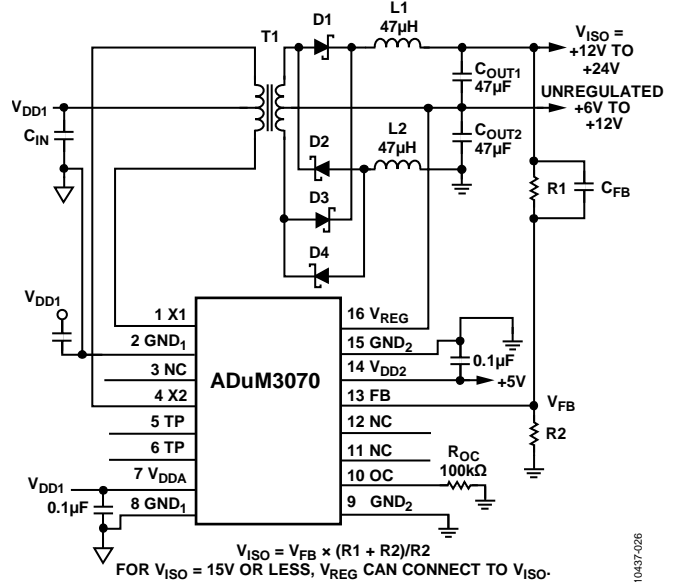

Figure 32. Doubling Power Supply

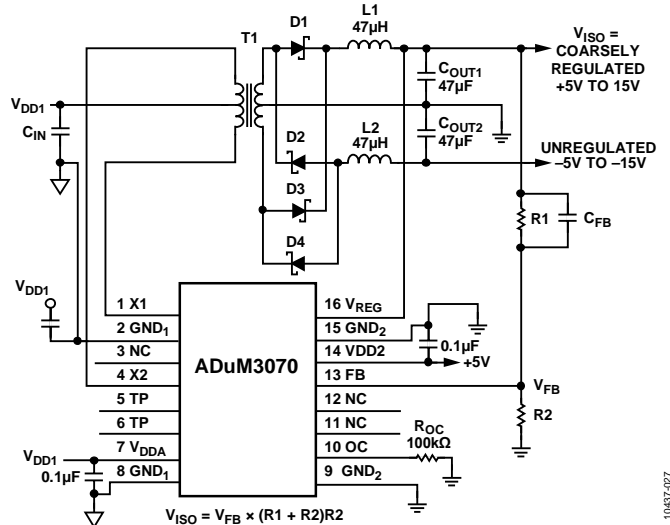

Figure 33. Positive and Unregulated Negative Supply

TRANSFORMER DESIGN

Transformers have been designed for use in the circuits shown in Figure 31, Figure 32, and Figure 33 and are listed in Table 13. The design of a transformer for the ADuM3070 can differ from some isolated dc-to-dc converter designs that do not regulate the output voltage. The output voltage is regulated by a PWM controller in the ADuM3070 that varies the duty cycle of the primary side switches in response to a secondary side feedback voltage, V_{FB} , received through an isolated digital channel. The internal controller has a limit of 40% maximum duty cycle.

TRANSFORMER TURNS RATIO

To determine the transformer turns ratio, and taking into account the losses for the primary switches and the losses for the secondary diodes and inductors, the external transformer turns ratio for the ADuM3070 can be calculated by

$$\frac{N_S}{N_P} = \frac{V_{ISO} + V_D}{V_{DD1(MIN)} \times D \times 2}$$

where:

N_S/N_P is the primary to secondary turns ratio.

V_{ISO} is the isolated output supply voltage.

V_D is the Schottky diode voltage drop (0.5 V maximum).

$V_{DD1(MIN)}$ is the minimum input supply voltage.

D is the duty cycle = 0.30 for a 30% typical duty cycle, 40% is maximum, and a multiplier factor of 2 is used for the push-pull switching cycle.

For Figure 31, the 5 V to 5 V reference design in Table 13, with $V_{DD1(MIN)} = 4.5$ V, the turns ratio is $N_S/N_P = 2$.

For a similar 3.3 V input to 3.3 V output, isolated single power supply and with $V_{DD1(MIN)} = 3.0$ V, the turns ratio is also $N_S/N_P = 2$. Therefore, the same transformer turns ratio $N_S/N_P = 2$ can be used for the three single power applications (5 V to 5 V, 5 V to 3.3 V, and 3.3 V to 3.3 V).

For Figure 32, the circuit uses double windings and diode pairs to create a doubler circuit; therefore, half the output voltage, $V_{ISO}/2$, is used in the equation.

$$\frac{N_S}{N_P} = \frac{\frac{V_{ISO}}{2} + V_D}{V_{DD1(MIN)} \times D \times 2}$$

N_S/N_P is the primary to secondary turns ratio.

$V_{ISO}/2$ is used in the equation because the circuit uses two pairs of diodes creating a doubler circuit.

V_D is the Schottky diode voltage drop (0.5 V maximum).

$V_{DD1(MIN)}$ is the minimum input supply voltage.

D is the duty cycle, which is 0.30 for a 30% typical duty cycle and 0.40 for a 40% maximum duty cycle, and a multiplier factor of two is used for the push-pull switching cycle.

For Figure 32, the 5 V to 15 V reference design in Table 13, with $V_{DD1(MIN)} = 4.5$ V, results in a turns ratio of $N_S/N_P = 3$.

For Figure 33, the circuit also uses double windings and diode pairs to create a doubler circuit; however, because a positive and negative output voltage is created, V_{ISO} is used in the equation.

$$\frac{N_S}{N_P} = \frac{V_{ISO} + V_D}{V_{DD1(MIN)} \times D \times 2}$$

where:

N_S/N_P is the primary to secondary turns ratio.

V_{ISO} is the isolated output supply voltage and is used in the equation because the circuit uses two pairs of diodes creating a doubler circuit with a positive and negative output.

V_D is the Schottky diode voltage drop (0.5 V maximum).

$V_{DD1(MIN)}$ is the minimum input supply voltage, and a multiplier factor of 2 is used for the push-pull switching cycle.

D is the duty cycle; in this case, a higher duty cycle of $D = 0.35$ for a 35% typical duty cycle (40% maximum duty cycle) was used in the Figure 33 circuit to reduce the maximum voltages seen by the diodes for a ± 15 V supply.

For Figure 33, the +5 V to ± 15 V reference design in Table 13, with $V_{DD1(MIN)} = 4.5$ V, results in a turns ratio of $N_S/N_P = 5$.

TRANSFORMER ET CONSTANT

The next transformer design factor to consider is the ET constant. This constant determines the minimum $V \times \mu s$ constant of the transformer over the operating temperature. ET values of $14 V \times \mu s$ and $18 V \times \mu s$ were selected for the ADuM3070 designs listed in Table 13 using the following equation:

$$ET(MIN) = \frac{V_{DD1(MAX)}}{f_{SW(MIN)} \times 2}$$

where:

$V_{DD1(MAX)}$ is the maximum input supply voltage.

$f_{SW(MIN)}$ is the minimum primary switching frequency = 300 kHz in startup, and a multiplier factor of 2 is used for the push-pull switching cycle.

TRANSFORMER PRIMARY INDUCTANCE AND RESISTANCE

Another important characteristic of the transformer for designs with the ADuM3070 is the primary inductance. Transformers for the ADuM3070 are recommended to have between 60 μH to 100 μH of inductance per primary winding. Values of primary inductance in this range are needed for smooth operation of the ADuM3070 pulse-by-pulse current-limit circuit, which can help protect against build up of saturation currents in the transformer. If the inductance is specified for the total of both primary windings, for example, as 400 μH , the inductance of one winding is $\frac{1}{4}$ of two equal windings, or 100 μH .

Another important characteristic of the transformer for designs with the ADuM3070 is primary resistance. Primary resistance as low as is practical (less than 1 Ω) helps reduce losses and improves efficiency. The total primary resistance can be measured and specified, and is shown for the transformers in Table 13.

Table 13. Transformer Reference Designs

Part No.	Manufacturer	Turns Ratio, PRI:SEC	ET Constant (V × μs Min)	Total Primary Inductance (μH)	Total Primary Resistance (Ω)	Isolation Voltage (rms)	Isolation Type	Reference
JA4631-BL	Coilcraft	1CT:2CT	18	255	0.2	2500	Basic	Figure 31
JA4650-BL	Coilcraft	1CT:3CT	18	255	0.2	2500	Basic	Figure 32
KA4976-AL	Coilcraft	1CT:5CT	18	255	0.2	2500	Basic	Figure 33
TGSAD-260V6LF	Halo Electronics	1CT:2CT	14	389	0.8	2500	Supplemental	Figure 31
TGSAD-290V6LF	Halo Electronics	1CT:3CT	14	389	0.8	2500	Supplemental	Figure 32
TGSAD-292V6LF	Halo Electronics	1CT:5CT	14	389	0.8	2500	Supplemental	Figure 33
TGAD-260NARL	Halo Electronics	1CT:2CT	14	389	0.8	1500	Functional	Figure 31
TGAD-290NARL	Halo Electronics	1CT:3CT	14	389	0.8	1500	Functional	Figure 32
TGAD-292NARL	Halo Electronics	1CT:5CT	14	389	0.8	1500	Functional	Figure 33

TRANSFORMER ISOLATION VOLTAGE

Isolation voltage and isolation type should be determined for the requirements of the application and then specified. The transformers in Table 13 have been specified for 2500 V rms for supplemental or basic isolation and for 1500 V rms for functional isolation. Other isolation levels and isolation voltages can be specified and requested from the manufacturers that are listed in Table 13 or from other manufacturers.

SWITCHING FREQUENCY

The ADuM3070 switching frequency can be adjusted from 200 kHz to 1 MHz by changing the value of the R_{OC} resistor shown in Figure 31, Figure 32, and Figure 33. The value of the R_{OC} resistor needed for the desired switching frequency can be determined from the switching frequency vs. R_{OC} resistance curve shown in Figure 4. The output filter inductor value and output capacitor value for the ADuM3070 application schematics have been designed to be stable over the switching frequency range from 500 kHz to 1 MHz, when loaded from 10% to 90% of the maximum load.

The ADuM3070 also has an open-loop mode where the output voltage is not regulated and is dependent on the transformer turns ratio, N_s/N_p, and the conditions of the output including output load current and the losses in the dc-to-dc converter circuit. This open-loop mode is selected when the OC pin is connected high to the V_{DD2} pin. In open-loop mode, the switching frequency is 318 kHz.

TRANSIENT RESPONSE

The load transient response of the output voltage of the ADuM3070 for 10% to 90% of the full load is shown in Figure 19 to Figure 26 for the application schematics in Figure 31 and Figure 32. The response shown is slow but stable and can have more output change than desired for some applications. The output voltage change with load transient has been reduced, and the output has been shown to remain stable by adding more inductance to the output circuits, as shown in the second V_{ISO} output waveform in Figure 19 to Figure 26.

For additional improvement in transient response, add a 0.1 μF ceramic capacitor (C_{FB}) in parallel with the high feedback resistor. As shown in Figure 19 to Figure 26, this value helps reduce the overshoot and undershoot during load transients.

COMPONENT SELECTION

Power supply bypassing is required at the input and output supply pins. Note that a low ESR ceramic bypass capacitor of 0.1 μF is required on Side 1 between Pin 7 and Pin 8, and on Side 2 between Pin 14 and Pin 15, as close to the chip pads as possible.

The power supply section of the ADuM3070 uses a high oscillator frequency to efficiently pass power through the external power transformer. Bypass capacitors are required for several operating frequencies. Noise suppression requires a low inductance, high frequency capacitor; ripple suppression and proper regulation require a large value capacitor. To suppress noise and reduce ripple, large valued ceramic capacitors of X5R or X7R dielectric type are recommended. The recommended capacitor value is 10 μF for V_{DD1} and 47 μF for V_{ISO}. These capacitors have a low ESR and are available in moderate 1206 or 1210 sizes for voltages up to 10 V. For output voltages larger than 10 V, two 22 μF ceramic capacitors can be used in parallel. See Table 14 for recommended components.

Inductors must be selected based on the value and supply current needed. Most applications with switching frequencies between 500 kHz and 1 MHz and load transients between 10% and 90% of full load are stable with the 47 μH inductor value listed in Table 14. Values as large as 200 μH can be used for power supply applications with a switching frequency as low as 200 kHz to help stabilize the output voltage or for improved load transient response (see Figure 19 to Figure 26). Inductors in a small 1212 or 1210 size are listed in Table 14 with a 47 μH value and a 0.41 A current rating to handle the majority of applications below a 400 mA load, and with a 100 μH value and a 0.34 A current rating to handle a load to 300 mA.

Schottky diodes are recommended for their low forward voltage to reduce losses and their high reverse voltage of up to 40 V to withstand the peak voltages available in the doubling circuit shown in Figure 32 and Figure 33.

Table 14. Recommended Components

Part Number	Manufacturer	Value
GRM32ER71A476KE15L	Murata	47 μF, 10 V, X7R, 1210
GRM32ER71C226KEA8L	Murata	22 μF, 16 V, X7R, 1210
GRM31CR71A106KA01L	Murata	10 μF, 10 V, X7R, 1206
MBR0540T1/D	ON Semiconductor	0.5 A, 40 V, Schottky, SOD-123
LQH3NPN470MM0	Murata	47 μH, 0.41 A, 1212
ME3220-104KL	Coilcraft	100 μH, 0.34 A, 1210

PRINTED CIRCUIT BOARD (PCB) LAYOUT

Note that the total lead length between the ends of the low ESR capacitor and the V_{DDx} and GND_x pins must not exceed 2 mm. See Figure 34 for the recommended PCB layout.

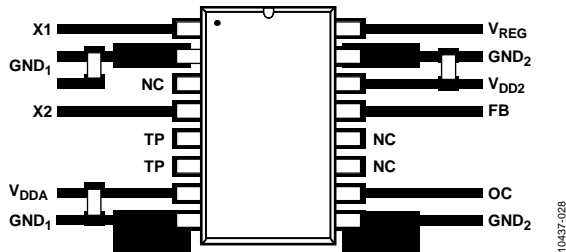

Figure 34. Recommended PCB Layout

In applications involving high common-mode transients, ensure that board coupling across the isolation barrier is minimized. Furthermore, design the board layout such that any coupling that does occur equally affects all pins on a given component side. Failure to ensure this can cause voltage differentials between pins, exceeding the absolute maximum ratings specified in Table 10, thereby leading to latch-up and/or permanent damage.

The ADuM3070 is a power device that dissipates about 1 W of power when fully loaded. Because it is not possible to apply a heat sink to an isolation device, the device primarily depends on heat dissipation into the PCB through the GND_x pins. If the device is used at high ambient temperatures, care must be taken to provide a thermal path from the GND_x pins to the PCB ground plane.

The board layout shows enlarged pads for the GND_x pins (Pin 2 and Pin 8) on Side 1 and (Pin 9 and Pin 15) on Side 2. Implement large diameter vias from the pad to the ground planes and power planes to increase thermal conductivity and to reduce inductance. Multiple vias in the thermal pads can significantly reduce temperatures inside the chip. The dimensions of the expanded pads are left to the discretion of the designer and the available board space.

THERMAL ANALYSIS

The ADuM3070 parts consist of two internal die attached to a split lead frame with two die attach paddles. For the purposes of thermal analysis, the die is treated as a thermal unit, with the highest junction temperature reflected in the θ_{JA} from Table 5. The value of θ_{JA} is based on measurements taken with the devices mounted on a JEDEC standard, 4-layer board with fine width traces and still air. Under normal operating conditions, the ADuM3070 devices operate at full load across the full temperature range without derating the output current. However, following the recommendations in the Printed Circuit Board (PCB) Layout section decreases thermal resistance to the PCB, allowing increased thermal margins in high ambient temperatures. The ADuM3070 has a thermal shutdown circuit that shuts down the dc-to-dc converter of the ADuM3070 when a die temperature of about 160°C is reached. When the die cools below about 140°C, the ADuM3070 dc-to-dc converter turns on again.

POWER CONSUMPTION

The total input supply current is equal to the sum of the I_{DD1} primary transformer current and the ADuM3070 input current, I_{DDA}.

The following relationship allows the total I_{IN} current to be:

$$I_{IN} = (I_{ISO} \times V_{ISO}) / (E \times V_{DD1}) \tag{1}$$

where:

I_{IN} is the total supply input current.

I_{ISO} is the current drawn by the secondary side external load.

E is the power supply efficiency at the given output load from Figure 8 or Figure 14 at the V_{ISO} and V_{DD1} condition of interest.

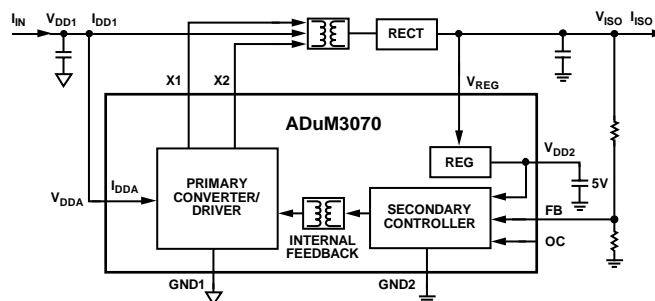

- NOTES
1. V_{DD1} IS THE POWER SUPPLY FOR THE PUSH-PULL TRANSFORMER.
 2. V_{DDA} IS THE POWER SUPPLY OF SIDE 1 OF THE ADuM3070.

Figure 35. Supply Currents

POWER CONSIDERATIONS

Soft Start Mode and Current-Limit Protection

When the ADuM3070 first receives power from V_{DD1} , it is in soft start mode, and the output voltage, V_{ISO} , is increased gradually while it is below the startup threshold. In soft start mode, to limit the peak current during V_{ISO} power-up, the primary converter gradually increases the width of the PWM signal. When the output voltage is larger than the start-up threshold, the PWM signal can be transferred from the secondary controller to the primary converter, and the dc-to-dc converter switches from soft start mode to the normal PWM control mode. If a short circuit occurs, the push-pull converter shuts down for about 2 ms and then enters soft start mode. If, at the end of soft start, a short circuit still exists, the process is repeated, which is called hiccup mode. If the short circuit is cleared, the ADuM3070 enters normal operation.

The ADuM3070 has a pulse-by-pulse current limit, which is active at startup and during normal operation, that protects the primary switches, X1 and X2, from exceeding approximately 1.3 A peak, protecting the transformer windings.

INSULATION LIFETIME

All insulation structures eventually break down when subjected to voltage stress over a sufficiently long period. The rate of insulation degradation is dependent on the characteristics of the voltage waveform applied across the insulation. Analog Devices, Inc., conducts an extensive set of evaluations to determine the lifetime of the insulation structure within the ADuM3070. Accelerated life testing is performed using voltage levels higher than the rated continuous working voltage. Acceleration factors for several operating conditions are determined, allowing calculation of the time to failure at the working voltage of interest. The values shown in Table 11 summarize the peak voltages for 50 years of service life in several operating conditions. In many cases, the working voltage approved by agency testing is higher than the 50-year service life voltage. Operation at working voltages higher than the service life voltage listed leads to premature insulation failure.

The insulation lifetime of the ADuM3070 depends on the voltage waveform type imposed across the isolation barrier. The iCoupler insulation structure degrades at different rates, depending on whether the waveform is bipolar ac, dc, or unipolar ac. Figure 36, Figure 37, and Figure 38 illustrate these different isolation voltage waveforms.

Bipolar ac voltage is the most stringent environment. A 50-year operating lifetime under the bipolar ac condition determines the Analog Devices recommended maximum working voltage.

In the case of unipolar ac or dc voltage, the stress on the insulation is significantly lower. This allows operation at higher working voltages while still achieving a 50-year service life. The working voltages listed in Table 11 can be applied while maintaining the 50-year minimum lifetime, if the voltage conforms to either the unipolar ac or dc voltage cases. Treat any cross-insulation voltage waveform that does not conform to Figure 37 or Figure 38 as a bipolar ac waveform, and limit its peak voltage to the 50-year lifetime voltage value listed in Table 11.

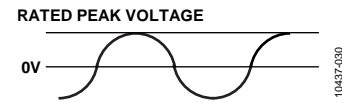

Figure 36. Bipolar AC Waveform

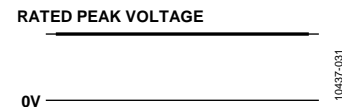
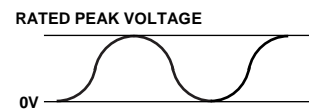

Figure 37. DC Waveform



NOTES
1. THE VOLTAGE IS SHOWN SINUSOIDAL FOR ILLUSTRATION PURPOSES ONLY. IT IS MEANT TO REPRESENT ANY VOLTAGE WAVEFORM VARYING BETWEEN 0 AND SOME LIMITING VALUE. THE LIMITING VALUE CAN BE POSITIVE OR NEGATIVE, BUT THE VOLTAGE CANNOT CROSS 0V.

Figure 38. Unipolar AC Waveform

OUTLINE DIMENSIONS

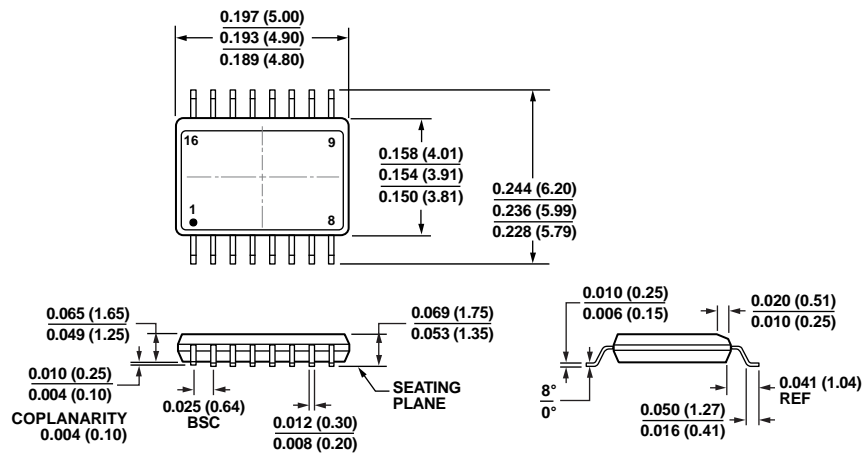

COMPLIANT TO JEDEC STANDARDS MO-137-AB
 CONTROLLING DIMENSIONS ARE IN INCHES; MILLIMETER DIMENSIONS
 (IN PARENTHESES) ARE ROUNDED-OFF INCH EQUIVALENTS FOR
 REFERENCE ONLY AND ARE NOT APPROPRIATE FOR USE IN DESIGN.

Figure 39. 16-Lead Shrink Small Outline Package [QSOP]
 (RQ-16)

Dimension shown in inches and (millimeters)

01-28-2008-A

ORDERING GUIDE

Model ^{1,2}	Temperature Range	Package Description	Package Option
ADuM3070ARQZ	-40°C to +105°C	16-Lead Shrink Small Outline Package [QSOP]	RQ-16
EVAL-ADuM3070EBZ		Evaluation Board	

¹ Tape and reel are available. The addition of an -RL7 suffix designates a 7" (1000 units) tape and reel option.

² Z = RoHS Compliant Part.

NOTES