

PLEASE CHECK WWW.MOLEX.COM FOR LATEST PART INFORMATION

Part Number: [63881-1800](#)
Status: **Active**
Description: Mini-Mac™ Applicator

Documents:

[RoHS Certificate of Compliance \(PDF\)](#)

General

Product Family	Application Tooling
Series	T9999
Function	Crimp
Geographic Area	Global
Level of Automation	Automatic, Semi-Automatic
More Detailed Tech Information	applicationtooling@molex.com
Product Name	Mini-Mac™
Survey	www.molex.com//review/apptool_survey.html
Tool Type	Mini-Mac Applicator
UPC	822348765416

Material Info

Reference - Drawing Numbers

Application Tooling Documents

638811800, TM-638800000, TM-638800000SP,
 TM-640160065, TM-640160065CN, TM-640160065DE,
 TM-640160065FR, TM-640160065IT,
 TM-640160065JP, TM-640160065KR,
 TM-640160065MY, TM-640160065PL,
 TM-640160065RU, TM-640160065SK,
 TM-640160065SP, TM-640160065TH,
 TM-640160065TW, TM-640160065VN

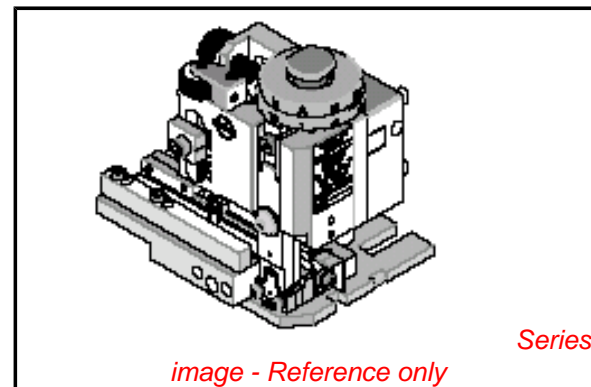

image - Reference only

EU RoHS **China RoHS**

Compliance Status

Not Reviewed

REACH SVHC

Not Reviewed

Low-Halogen Status

Not Reviewed

Need more information on product environmental compliance?

Email productcompliance@molex.com
 For a multiple part number RoHS Certificate of Compliance, [click here](#)

Please visit the [Contact Us](#) section for any non-product compliance questions.

Search Parts in this Series

[T9999Series](#)

Use With

Molex TM-3000™: [63801-7200](#) ,
[63801-7300](#) , Molex TM-4000™:
[63801-7600](#) , Molex TM-2000™:
[63800-8300](#) , [63800-8400](#) , and Most
 Industry Standard Presses or Wire Process
 Machines