

## ISL81387, ISL41387

±15kV ESD Protected, 5V, Dual Protocol (RS-232/RS-485) Transceivers

FN6201  
Rev 4.00  
June 9, 2014

These devices are BiCMOS interface ICs that are user configured as either a single RS-422, RS-485 differential transceiver, or as a dual (2 Tx, 2 Rx) RS-232 transceiver.

In RS-232 mode, the on-board charge pump generates RS-232 compliant ±5V Tx output levels, from a supply as low as 4.5V. Four small 0.1µF capacitors are required for the charge pump. The transceivers are RS-232 compliant, with the Rx inputs handling up to ±25V, and the Tx outputs handling ±12V.

In RS-485 mode, the transceivers support both the RS-485 and RS-422 differential communication standards. The RS-485 receiver features "full fail-safe" operation, so the Rx output remains in a high state if the inputs are open or shorted together. The RS-485 transmitter supports up to three data rates, two of which are slew rate limited for problem free communications. The charge pump disables in RS-485 mode, thereby saving power, minimizing noise, and eliminating the charge pump capacitors.

Both RS-232, RS-485 modes feature loopback and shutdown functions. The loopback mode internally connects the Tx outputs to the corresponding Rx input, which facilitates the implementation of board level self test functions. The outputs remain connected to the loads during loopback, so connection problems (e.g., shorted connectors or cables) can be detected. The shutdown mode disables the Tx and Rx outputs, disables the charge pump if in RS-232 mode, and places the IC in a low current (35µA) mode.

The ISL41387 is a QFN packaged device that offers additional functionality, including a lower speed and edge rate option (115kbps) for EMI sensitive designs, or to allow longer bus lengths. It also features a logic supply voltage pin (V<sub>L</sub>) that sets the V<sub>OH</sub> level of logic outputs, and the switching points of logic inputs, to be compatible with another supply voltage in mixed voltage systems. The QFN's choice of active high or low Rx enable pins increases design flexibility, allowing Tx/Rx direction control via a single signal by connecting DEN and RXEN together.

For a dual port version of these devices, please see the [ISL81334, ISL41334 datasheet](#).

## Features

- 5V powered, user selectable RS-232 or RS-485, RS-422 interface port (two RS-232 transceivers or one RS-485, RS-422 transceiver)
- ±15kV (HBM) ESD protected bus pins (RS-232 or RS-485)
- True flow-through pinouts simplify board layouts
- Pb-Free (RoHS compliant)
- Large (2.7V) differential V<sub>OUT</sub> for improved noise immunity in RS-485, RS-422 networks
- Full fail-safe (open/short) Rx in RS-485, RS-422 mode
- Loopback mode facilitates board self test functions
- User selectable RS-485 data rates . . . . . 20Mbps
  - Slew rate limited . . . . . 460kbps
  - Slew rate limited (ISL41387 only) . . . . . 115kbps
- Fast RS-232 data rate . . . . . up to 650kbps
- Low current shutdown mode . . . . . 35µA
- QFN package saves board space (ISL41387 only)
- Logic supply pin (V<sub>L</sub>) eases operation in mixed supply systems (ISL41387 only)

## Applications

- Gaming applications (e.g., slot machines)
- Single board computers
- Factory automation
- Security networks
- Industrial/process control networks
- Level translators (e.g., RS-232 to RS-422)
- Point of sale equipment

## Related Literature

- [AN1378](#), "Implementing a Three Pin, Half-Duplex, Dual Protocol (RS-232/RS-485) Interface Using the ISL81387 or ISL41387."

TABLE 1. SUMMARY OF FEATURES

PART NUMBER	NO. OF PORTS	PACKAGE OPTIONS	RS-485 DATA RATE (bps)	RS-232 DATA RATE (kbps)	V <sub>L</sub> PIN?	ACTIVE H or L Rx ENABLE?	LOW POWER SHUTDOWN?
ISL81387	1	20 Ld SOIC, 20 Ld SSOP	20M, 460k	650	NO	H	YES
ISL41387	1	40 Ld QFN (6mmx6mm)	20M, 460k, 115k	650	YES	BOTH	YES

## Ordering Information

PART NUMBER (Notes 1, 2)	PART MARKING	TEMP. RANGE (°C)	PACKAGE (Pb-Free)	PKG. DWG. #
ISL81387IAZ	81387 IAZ	-40 to +85	20 Ld SSOP	M20.209
ISL81387IBZ	ISL81387IBZ	-40 to +85	20 Ld SOIC	M20.3
ISL41387IRZ	41387 IRZ	-40 to +85	40 Ld QFN	L40.6x6

**NOTES:**

1. Add "-T\*" suffix for tape and reel. Please refer to TB347 for details on reel specifications.
2. These Intersil Pb-free plastic packaged products employ special Pb-free material sets, molding compounds/die attach materials, and 100% matte tin plate plus anneal (e3 termination finish, which is RoHS compliant and compatible with both SnPb and Pb-free soldering operations). Intersil Pb-free products are MSL classified at Pb-free peak reflow temperatures that meet or exceed the Pb-free requirements of IPC/JEDEC J STD-020.

## Pin Configurations



TABLE 2. ISL81387 FUNCTION TABLE

INPUTS					RECEIVER OUTPUTS		DRIVER OUTPUTS		DRIVER SPEED (Mbps)	CHARGE PUMPS (Note 3)	LOOPBACK (Note 4)	MODE
485/232	ON	RXEN	DEN	SLEW	R <sub>A</sub>	R <sub>B</sub>	Y	Z				
0	1	0	0	N.A.	High-Z	High-Z	High-Z	High-Z	-	ON	OFF	RS-232
0	1	0	1	N.A.	High-Z	High-Z	ON	ON	0.46	ON	OFF	RS-232
0	1	1	0	N.A.	ON	ON	High-Z	High-Z	-	ON	OFF	RS-232
0	1	1	1	N.A.	ON	ON	ON	ON	0.46	ON	OFF	RS-232
0	0	0	1	N.A.	High-Z	High-Z	ON	High-Z	0.46	ON	OFF	RS-232
0	0	1	0	N.A.	High-Z	ON	ON	High-Z	0.46	ON	OFF	RS-232
0	0	1	1	N.A.	ON	ON	ON	ON	0.46	ON	ON	RS-232
X	0	0	0	X	High-Z	High-Z	High-Z	High-Z	-	OFF	OFF	Shutdown
1	1	0	0	X	High-Z	High-Z	High-Z	High-Z	-	OFF	OFF	RS-485
1	X	0	1	1/0	High-Z	High-Z	ON	ON	20/0.46	OFF	OFF	RS-485
1	X	1	0	X	ON	High-Z	High-Z	High-Z	-	OFF	OFF	RS-485
1	1	1	1	1/0	ON	High-Z	ON	ON	20/0.46	OFF	OFF	RS-485
1	0	1	1	1/0	ON	High-Z	ON	ON	20/0.46	OFF	ON	RS-485

NOTES:

- 3. Charge pumps are on if in RS-232 mode and ON or DEN or RXEN are high.
- 4. Loopback is enabled when ON = 0, and DEN = RXEN = 1.

### ISL81387 Truth Tables

RS-232 TRANSMITTING MODE					
INPUTS (ON = 1)				OUTPUTS	
485/232	DEN	D <sub>Y</sub>	D <sub>Z</sub>	Y	Z
0	1	0	0	1	1
0	1	0	1	1	0
0	1	1	0	0	1
0	1	1	1	0	0
0	0	X	X	High-Z	High-Z

RS-232 RECEIVING MODE					
INPUTS (ON = 1)				OUTPUT	
485/232	RXEN	A	B	R <sub>A</sub>	R <sub>B</sub>
0	1	0	0	1	1
0	1	0	1	1	0
0	1	1	0	0	1
0	1	1	1	0	0
0	1	Open	Open	1	1
0	0	X	X	High-Z	High-Z

RS-485 TRANSMITTING MODE						
INPUTS (ON = 1)				OUTPUTS		
485/232	DEN	D <sub>Y</sub>	SLEW	Y	Z	DATA RATE (Mbps)
1	1	0	1	1	0	20
1	1	1	1	0	1	20
1	1	0	0	1	0	0.46
1	1	1	0	0	1	0.46
1	0	X	X	High-Z	High-Z	-

RS-485 RECEIVING MODE					
INPUTS (ON = 1)				OUTPUT	
485/232	RXEN	B-A		R <sub>A</sub>	R <sub>B</sub>
1	1	≥ -40mV		1	High-Z
1	1	≤ -200mV		0	High-Z
1	1	Open or Shorted together		1	High-Z
1	0	X		High-Z	High-Z

TABLE 3. ISL41387 FUNCTION TABLE

INPUTS						RECEIVER OUTPUTS		DRIVER OUTPUTS		DRIVER DATA RATE (Mbps)	CHARGE PUMPS (Note 5)	MODE
485/232	ON	R $\overline{\text{XEN}}$ and/or RXEN	DEN	SLEW	SPB	R <sub>A</sub>	R <sub>B</sub>	Y	Z			
0	1	1 and 0	0	N.A.	N.A.	High-Z	High-Z	High-Z	High-Z	-	ON	RS-232
0	1	1 and 0	1	N.A.	N.A.	High-Z	High-Z	ON	ON	0.46	ON	RS-232
0	1	0 or 1	0	N.A.	N.A.	ON	ON	High-Z	High-Z	-	ON	RS-232
0	1	0 or 1	1	N.A.	N.A.	ON	ON	ON	ON	0.46	ON	RS-232
0	0	1 and 0	1	N.A.	N.A.	High-Z	High-Z	ON	High-Z	0.46	ON	RS-232
0	0	0 or 1	0	N.A.	N.A.	High-Z	ON	ON	High-Z	0.46	ON	RS-232
0	0	0 or 1	1	N.A.	N.A.	ON	ON	ON	ON	0.46	ON	RS-232 (Note 6)
X	0	1 and 0	0	X	X	High-Z	High-Z	High-Z	High-Z	-	OFF	Shutdown
1	1	1 and 0	0	X	X	High-Z	High-Z	High-Z	High-Z	-	OFF	RS-485
1	X	1 and 0	1	0	1/0	High-Z	High-Z	ON	ON	0.46/0.115	OFF	RS-485
1	X	1 and 0	1	1	X	High-Z	High-Z	ON	ON	20	OFF	RS-485
1	X	0 or 1	0	X	X	ON	High-Z	High-Z	High-Z	-	OFF	RS-485
1	1	0 or 1	1	0	1/0	ON	High-Z	ON	ON	0.46/0.115	OFF	RS-485
1	1	0 or 1	1	1	X	ON	High-Z	ON	ON	20	OFF	RS-485
1	0	0 or 1	1	0	1/0	ON	High-Z	ON	ON	0.46/0.115	OFF	RS-485 (Note 6)
1	0	0 or 1	1	1	X	ON	High-Z	ON	ON	20	OFF	RS-485 (Note 6)

NOTES:

- 5. Charge pumps are on if in RS-232 mode and ON or DEN or RXEN is high, or  $\overline{\text{RXEN}}$  is low.
- 6. Loopback is enabled when ON = 0, and DEN = 1, and (RXEN = 1 or  $\overline{\text{RXEN}}$  = 0).

### ISL41387 Truth Tables

RS-232 TRANSMITTING MODE					
INPUTS (ON = 1)				OUTPUTS	
485/232	DEN	D <sub>Y</sub>	D <sub>Z</sub>	Y	Z
0	1	0	0	1	1
0	1	0	1	1	0
0	1	1	0	0	1
0	1	1	1	0	0
0	0	X	X	High-Z	High-Z

RS-232 RECEIVING MODE					
INPUTS (ON = 1)				OUTPUT	
485/232	R $\overline{\text{XEN}}$ and/or RXEN	A	B	R <sub>A</sub>	R <sub>B</sub>
0	0 or 1	0	0	1	1
0	0 or 1	0	1	1	0
0	0 or 1	1	0	0	1
0	0 or 1	1	1	0	0
0	0 or 1	Open	Open	1	1
0	1 and 0	X	X	High-Z	High-Z

RS-485 TRANSMITTING MODE							
INPUTS (ON = 1)					OUTPUTS		DATA
485/232	DEN	SLEW	SPB	D <sub>Y</sub>	Y	Z	Mbps
1	1	0	0	0/1	1/0	0/1	0.115
1	1	0	1	0/1	1/0	0/1	0.460
1	1	1	X	0/1	1/0	0/1	20
1	0	X	X	X	High-Z	High-Z	-

RS-485 RECEIVING MODE				
INPUTS (ON = 1)			OUTPUT	
485/232	R $\overline{\text{XEN}}$ and/or RXEN	B-A	R <sub>A</sub>	R <sub>B</sub>
1	0 or 1	≥ -40mV	1	High-Z
1	0 or 1	≤ -200mV	0	High-Z
1	0 or 1	Open or Shorted together	1	High-Z
1	1 and 0	X	High-Z	High-Z

## Pin Descriptions

PIN	MODE	FUNCTION
485/ $\overline{232}$	BOTH	Interface mode select input. High for RS-485 Mode and low for RS-232 Mode.
DEN	BOTH	Driver output enable. The driver outputs, Y and Z, are enabled by bringing DEN high. They are high impedance when DEN is low.
GND	BOTH	Ground connection. This is also the potential of the QFN's thermal exposed pad (EP).
NC	BOTH	No Connection.
ON	BOTH	In RS-232 mode only, ON high enables the charge pumps. ON low, with DEN and RXEN low (and $\overline{RXEN}$ high if QFN), turns off the charge pumps (in RS-232 mode), and in either mode places the device in low power shutdown. In both modes, when ON is low, and DEN is high, and RXEN is high or $\overline{RXEN}$ is low, loopback is enabled.
RXEN	BOTH	Receiver output enable. Rx is enabled when RXEN is high; Rx is high impedance when RXEN is low and, if using the QFN package, $\overline{RXEN}$ is high. When using the QFN and the active high Rx enable function, RXEN should be high or floating.
$\overline{RXEN}$	BOTH	Active low receiver output enable. Rx is enabled when $\overline{RXEN}$ is low; Rx is high impedance when $\overline{RXEN}$ is high and RXEN is low (i.e., to use active low Rx enable function, tie RXEN to GND). For single signal Tx/Rx direction control, connect $\overline{RXEN}$ to DEN. Internally pulled high. (QFN only)
V <sub>CC</sub>	BOTH	System power supply input (5V).
V <sub>L</sub>	BOTH	Logic-Level Supply. All TTL/CMOS inputs and outputs are powered by this supply. (QFN only)
A	RS-232	Receiver input with $\pm 15$ kV ESD protection. A low on A forces R <sub>A</sub> high; a high on A forces R <sub>A</sub> low.
	RS-485	Inverting receiver input with $\pm 15$ kV ESD protection.
B	RS-232	Receiver input with $\pm 15$ kV ESD protection. A low on B forces R <sub>B</sub> high; a high on B forces R <sub>B</sub> low.
	RS-485	Noninverting receiver input with $\pm 15$ kV ESD protection.
D <sub>Y</sub>	RS-232	Driver input. A low on D <sub>Y</sub> forces output Y high. Similarly, a high on D <sub>Y</sub> forces output Y low.
	RS-485	Driver input. A low on D <sub>Y</sub> forces output Y high and output Z low. Similarly, a high on D <sub>Y</sub> forces output Y low and output Z high.
D <sub>Z</sub>	RS-232	Driver input. A low on D <sub>Z</sub> forces output Z high. Similarly, a high on D <sub>Z</sub> forces output Z low.
SLEW	RS-485	Slew rate control. With the SLEW pin high, the drivers run at the maximum slew rate (20Mbps). With the SLEW pin low, the drivers run at a reduced slew rate (460kbps). On the QFN version, works in conjunction with SPB to select one of three RS-485 data rates. Internally pulled high in RS-485 mode.
SPB	RS-485	Speed control. Works in conjunction with the SLEW pin to select the 20Mbps, 460kbps or 115kbps RS-485 data rate. Internally pulled high. (QFN only)
R <sub>A</sub>	RS-232	Receiver output.
	RS-485	Receiver output: If B > A by at least -40mV, R <sub>A</sub> is high; If B < A by -200mV or more, R <sub>A</sub> is low; R <sub>A</sub> = High if A and B are unconnected (floating) or shorted together (i.e., full fail-safe).
R <sub>B</sub>	RS-232	Receiver output.
	RS-485	Not used. Output is high impedance, and unaffected by $\overline{RXEN}$ and RXEN.
Y	RS-232	Driver output with $\pm 15$ kV ESD protection.
	RS-485	Inverting driver output with $\pm 15$ kV ESD protection.
Z	RS-232	Driver output with $\pm 15$ kV ESD protection.
	RS-485	Noninverting driver output with $\pm 15$ kV ESD protection.
C1+	RS-232	External capacitor (voltage doubler) is connected to this lead. Not needed in RS-485 Mode.
C1-	RS-232	External capacitor (voltage doubler) is connected to this lead. Not needed in RS-485 Mode.
C2+	RS-232	External capacitor (voltage inverter) is connected to this lead. Not needed in RS-485 Mode.
C2-	RS-232	External capacitor (voltage inverter) is connected to this lead. Not needed in RS-485 Mode.
V+	RS-232	Internally generated positive RS-232 transmitter supply (+5.5V). C <sub>3</sub> not needed in RS-485 Mode.
V-	RS-232	Internally generated negative RS-232 transmitter supply (-5.5V). C <sub>4</sub> not needed in RS-485 Mode.

# Typical Operating Circuit

RS-232 MODE WITHOUT LOOPBACK



NOTE: PINOUT FOR SOIC AND SSOP

RS-232 MODE WITH LOOPBACK



NOTE: PINOUT FOR SOIC AND SSOP

RS-485 MODE WITHOUT LOOPBACK



NOTE: PINOUT FOR SOIC AND SSOP

RS-485 MODE WITH LOOPBACK

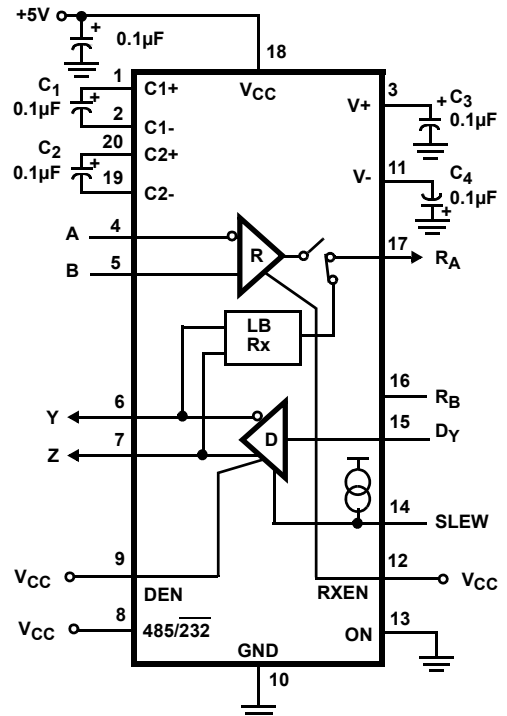

NOTE: PINOUT FOR SOIC AND SSOP

### Absolute Maximum Ratings (T<sub>A</sub> = +25 °C)

V <sub>CC</sub> to Ground	7V
V <sub>L</sub> (QFN Only)	-0.5V to V <sub>CC</sub> + 0.5V
Input Voltages	
All Except A, B	-0.5V to 7V
Input/Output Voltages	
A, B (Any Mode)	-25V to +25V
Y, Z (Any Mode, <a href="#">Note 7</a> )	-12.5V to +12.5V
R <sub>A</sub> , R <sub>B</sub> (non-QFN Package)	-0.5V to (V <sub>CC</sub> + 0.5V)
R <sub>A</sub> , R <sub>B</sub> (QFN Package)	-0.5V to (V <sub>L</sub> + 0.5V)
Output Short Circuit Duration	
Y, Z, R <sub>A</sub> , R <sub>B</sub>	Indefinite
ESD Rating	See Specification Table

### Thermal Information

Thermal Resistance	θ <sub>JA</sub> (°C/W)
20 Ld SOIC Package ( <a href="#">Note 9</a> )	65
20 Ld SSOP Package ( <a href="#">Note 9</a> )	60
40 Ld QFN Package ( <a href="#">Note 8</a> )	32
Maximum Junction Temperature (Plastic Package)	+150 °C
Maximum Storage Temperature Range	-65 °C to +150 °C
Pb-Free Reflow Profile	see <a href="#">TB493</a>

### Operating Conditions

Temperature Range	-40 °C to +85 °C
-------------------	------------------

**CAUTION:** Do not operate at or near the maximum ratings listed for extended periods of time. Exposure to such conditions may adversely impact product reliability and result in failures not covered by warranty.

**NOTES:**

- One output at a time, I<sub>OUT</sub> ≤ 100mA for ≤ 10 mins.
- θ<sub>JA</sub> is measured in free air with the component mounted on a high effective thermal conductivity test board with “direct attach” features. See Tech Brief [TB379](#).
- θ<sub>JA</sub> is measured with the component mounted on a high effective thermal conductivity test board in free air. See Tech Brief [TB379](#) for details.

### Electrical Specifications

Test Conditions: V<sub>CC</sub> = 4.5V to 5.5V, C<sub>1</sub> - C<sub>4</sub> = 0.1µF, V<sub>L</sub> = V<sub>CC</sub> (for QFN only), Unless Otherwise Specified.

Typicals are at V<sub>CC</sub> = 5V, T<sub>A</sub> = +25 °C ([Note 10](#)).

PARAMETER	SYMBOL	TEST CONDITIONS	TEMP (°C)	MIN ( <a href="#">Note 17</a> )	TYP	MAX ( <a href="#">Note 17</a> )	UNITS	
<b>DC CHARACTERISTICS - RS-485 DRIVER (485/232 = V<sub>CC</sub>)</b>								
Driver Differential V <sub>OUT</sub> (no load)	V <sub>OD1</sub>		Full	-	-	V <sub>CC</sub>	V	
Driver Differential V <sub>OUT</sub> (with load)	V <sub>OD2</sub>	R = 50Ω (RS-422) ( <a href="#">Figure 1</a> )	Full	2.5	3.1	-	V	
		R = 27Ω (RS-485) ( <a href="#">Figure 1</a> )	Full	2.2	2.7	5	V	
	V <sub>OD3</sub>	R <sub>D</sub> = 60Ω, R = 375Ω, V <sub>CM</sub> = -7V to 12V ( <a href="#">Figure 1</a> )	Full	2	2.7	5	V	
Change in Magnitude of Driver Differential V <sub>OUT</sub> for Complementary Output States	ΔV <sub>OD</sub>	R = 27Ω or 50Ω ( <a href="#">Figure 1</a> )	Full	-	0.01	0.2	V	
Driver Common-Mode V <sub>OUT</sub>	V <sub>OC</sub>	R = 27Ω or 50Ω ( <a href="#">Figure 1</a> ) ( <a href="#">Note 14</a> )	Full	-	-	3.1	V	
Change in Magnitude of Driver Common-Mode V <sub>OUT</sub> for Complementary Output States	ΔV <sub>OC</sub>	R = 27Ω or 50Ω ( <a href="#">Figure 1</a> ) ( <a href="#">Note 14</a> )	Full	-	0.01	0.2	V	
Driver Short-Circuit Current, V <sub>OUT</sub> = High or Low	I <sub>OS</sub>	-7V ≤ (V <sub>Y</sub> or V <sub>Z</sub> ) ≤ 12V ( <a href="#">Note 12</a> )	Full	35	-	250	mA	
Driver Three-State Output Leakage Current (Y, Z)	I <sub>OZ</sub>	Outputs Disabled, V <sub>CC</sub> = 0V or 5.5V	V <sub>OUT</sub> = 12V	Full	-	-	150	µA
			V <sub>OUT</sub> = -7V	Full	-150	-	-	µA
<b>DC CHARACTERISTICS - RS-232 DRIVER (485/232 = 0V)</b>								
Driver Output Voltage Swing	V <sub>O</sub>	All T <sub>OUTS</sub> Loaded with 3kΩ to Ground	Full	±5.0	+6/-7	-	V	
Driver Output Short-Circuit Current	I <sub>OS</sub>	V <sub>OUT</sub> = 0V	Full	-60	25/-35	60	mA	
<b>DC CHARACTERISTICS - LOGIC PINS (i.e., DRIVER AND CONTROL INPUT PINS)</b>								
Input High Voltage	V <sub>IH1</sub>	V <sub>L</sub> = V <sub>CC</sub> if QFN	Full	2	1.6	-	V	
	V <sub>IH2</sub>	V <sub>L</sub> = 3.3V (QFN Only)	Full	2	1.2	-	V	
	V <sub>IH3</sub>	V <sub>L</sub> = 2.5V (QFN Only)	Full	1.5	1	-	V	

**Electrical Specifications** Test Conditions:  $V_{CC} = 4.5V$  to  $5.5V$ ,  $C_1 - C_4 = 0.1\mu F$ ,  $V_L = V_{CC}$  (for QFN only), Unless Otherwise Specified.  
Typicals are at  $V_{CC} = 5V$ ,  $T_A = +25^\circ C$  (Note 10). (Continued)

PARAMETER	SYMBOL	TEST CONDITIONS	TEMP (°C)	MIN (Note 17)	TYP	MAX (Note 17)	UNITS	
Input Low Voltage	$V_{IL1}$	$V_L = V_{CC}$ if QFN	Full	-	1.4	0.8	V	
	$V_{IL2}$	$V_L = 3.3V$ (QFN Only)	Full	-	1	0.7	V	
	$V_{IL3}$	$V_L = 2.5V$ (QFN Only)	Full	-	0.8	0.5	V	
Input Current	$I_{IN1}$	Except SLEW, $\overline{RXEN}$ (QFN), and SPB (QFN)	Full	-2	-	2	$\mu A$	
	$I_{IN2}$	SLEW (Note 15), $\overline{RXEN}$ (QFN), and SPB (QFN)	Full	-25	-	25	$\mu A$	
<b>DC CHARACTERISTICS - RS-485 RECEIVER INPUTS (485/232 = <math>V_{CC}</math>)</b>								
Receiver Differential Threshold Voltage	$V_{TH}$	$-7V \leq V_{CM} \leq 12V$ , Full fail-safe	Full	-0.2	-	-0.04	V	
Receiver Input Hysteresis	$\Delta V_{TH}$	$V_{CM} = 0V$	25	-	35	-	mV	
Receiver Input Current (A, B)	$I_{IN}$	$V_{CC} = 0V$ or $4.5V$ to $5.5V$	$V_{IN} = 12V$	Full	-	-	0.8	mA
			$V_{IN} = -7V$	Full	-0.64	-	-	mA
Receiver Input Resistance	$R_{IN}$	$-7V \leq V_{CM} \leq 12V$ , $V_{CC} = 0$ (Note 13), or $4.5V \leq V_{CC} \leq 5.5V$	Full	15	-	-	k $\Omega$	
<b>DC CHARACTERISTICS - RS-232 RECEIVER INPUTS (485/232 = GND)</b>								
Receiver Input Voltage Range	$V_{IN}$		Full	-25	-	25	V	
Receiver Input Threshold	$V_{IL}$		Full	-	1.4	0.8	V	
	$V_{IH}$		Full	2.4	1.9	-	V	
Receiver Input Hysteresis	$\Delta V_{TH}$		25	-	0.5	-	V	
Receiver Input Resistance	$R_{IN}$	$V_{IN} = \pm 15V$ , $V_{CC}$ Powered up (Note 13)	Full	3	5	7	k $\Omega$	
<b>DC CHARACTERISTICS - RECEIVER OUTPUTS (485 OR 232 MODE)</b>								
Receiver Output High Voltage	$V_{OH1}$	$I_O = -2mA$ ( $V_L = V_{CC}$ if QFN)	Full	3.5	4.6	-	V	
	$V_{OH2}$	$I_O = -650\mu A$ , $V_L = 3V$ (QFN Only)	Full	2.6	2.9	-	V	
	$V_{OH3}$	$I_O = -500\mu A$ , $V_L = 2.5V$ (QFN Only)	Full	2	2.4	-	V	
Receiver Output Low Voltage	$V_{OL}$	$I_O = 3mA$	Full	-	0.1	0.4	V	
Receiver Short-Circuit Current	$I_{OSR}$	$0V \leq V_O \leq V_{CC}$	Full	7	-	85	mA	
Receiver Three-State Output Current	$I_{OZR}$	Output Disabled, $0V \leq V_O \leq V_{CC}$ (or $V_L$ for QFN)	Full	-	-	$\pm 10$	$\mu A$	
<b>POWER SUPPLY CHARACTERISTICS</b>								
No-Load Supply Current (Note 11)	$I_{CC232}$	$485/\overline{232} = 0V$ , $ON = V_{CC}$	Full	-	3.7	7	mA	
	$I_{CC485}$	$485/\overline{232} = V_{CC}$ , $ON = V_{CC}$	Full	-	1.6	5	mA	
Shutdown Supply Current	$I_{SHDN232}$	$ON = DEN = RXEN = 0V$ ( $\overline{RXEN} = SPB = V_{CC}$ if QFN)	Full	-	5	30	$\mu A$	
	$I_{SHDN485}$	$ON = DEN = RXEN = SLEW = 0V$ ( $\overline{RXEN} = V_{CC}$ , $SPB = 0V$ if QFN)	Full	-	35	60	$\mu A$	
<b>ESD CHARACTERISTICS</b>								
Bus Pins (A, B, Y, Z) Any Mode		Human Body Model	25	-	15	-	kV	
All Other Pins		Human Body Model	25	-	4	-	kV	
<b>RS-232 DRIVER and RECEIVER SWITCHING CHARACTERISTICS (485/232 = 0V, ALL VERSIONS AND SPEEDS)</b>								
Driver Output Transition Region Slew Rate	SR	$R_L = 3k\Omega$ , Measured From 3V to -3V or -3V to 3V	$C_L \geq 15pF$	Full	-	18	30	V/ $\mu s$
			$C_L \leq 2500pF$	Full	4	12	-	V/ $\mu s$



**Electrical Specifications** Test Conditions:  $V_{CC} = 4.5V$  to  $5.5V$ ,  $C_1 - C_4 = 0.1\mu F$ ,  $V_L = V_{CC}$  (for QFN only), Unless Otherwise Specified. Typical values are at  $V_{CC} = 5V$ ,  $T_A = +25^\circ C$  (Note 10). (Continued)

PARAMETER	SYMBOL	TEST CONDITIONS	TEMP (°C)	MIN (Note 17)	TYP	MAX (Note 17)	UNITS
Driver Output Transition Time	$t_r, t_f$	$R_L = 3k\Omega, C_L = 2500pF, 10\%$ to $90\%$	Full	0.22	1.2	3.1	$\mu s$
Driver Propagation Delay	$t_{DPHL}$	$R_L = 3k\Omega, C_L = 1000pF$ (Figure 6)	Full	-	1	2	$\mu s$
	$t_{DPLH}$		Full	-	1.2	2	$\mu s$
Driver Propagation Delay Skew	$t_{DSKEW}$	$t_{DPHL} - t_{DPLH}$ (Figure 6)	Full	-	240	400	ns
Driver Enable Time	$t_{DEN}$		25	-	800	-	ns
Driver Disable Time	$t_{DDIS}$	$R_L = 5k\Omega$ , Measured at $V_{OUT} = \pm 3V$	25	-	500	-	ns
Driver Enable Time from Shutdown	$t_{DENS D}$	$V_{OUT} = \pm 3.0V$ (Note 16)	25	-	20	-	$\mu s$
Driver Maximum Data Rate	$DR_D$	$R_L = 3k\Omega, C_L = 1000pF$ , One Transmitter Switching	Full	460	650	-	kbps
Receiver Propagation Delay	$t_{RPHL}$	$C_L = 15pF$ (Figure 7)	Full	-	50	120	ns
	$t_{RPLH}$		Full	-	40	120	ns
Receiver Propagation Delay Skew	$t_{RSKEW}$	$t_{RPHL} - t_{RPLH}$ (Figure 7)	Full	-	10	40	ns
Receiver Maximum Data Rate	$DR_R$	$C_L = 15pF$	Full	0.46	2	-	Mbps
<b>RS-485 DRIVER SWITCHING CHARACTERISTICS (FAST DATA RATE (20Mbps), <math>485/232 = V_{CC}</math>, SLEW = <math>V_{CC}</math>, ALL VERSIONS)</b>							
Driver Differential Input to Output Delay	$t_{DLH}, t_{DHL}$	$R_{DIFF} = 54\Omega, C_L = 100pF$ (Figure 2)	Full	15	30	50	ns
Driver Output Skew	$t_{SKEW}$	$R_{DIFF} = 54\Omega, C_L = 100pF$ (Figure 2)	Full	-	0.5	10	ns
Driver Differential Rise or Fall Time	$t_R, t_F$	$R_{DIFF} = 54\Omega, C_L = 100pF$ (Figure 2)	Full	3	11	20	ns
Driver Enable to Output Low	$t_{ZL}$	$C_L = 100pF, SW = V_{CC}$ (Figure 3)	Full	-	27	60	ns
Driver Enable to Output High	$t_{ZH}$	$C_L = 100pF, SW = GND$ (Figure 3)	Full	-	24	60	ns
Driver Disable from Output Low	$t_{LZ}$	$C_L = 15pF, SW = V_{CC}$ (Figure 3)	Full	-	31	60	ns
Driver Disable from Output High	$t_{HZ}$	$C_L = 15pF, SW = GND$ (Figure 3)	Full	-	24	60	ns
Driver Enable from Shutdown to Output Low	$t_{ZL(SHDN)}$	$R_L = 500\Omega, C_L = 100pF, SW = V_{CC}$ (Figure 3) (Note 16)	Full	-	65	250	ns
Driver Enable from Shutdown to Output High	$t_{ZH(SHDN)}$	$R_L = 500\Omega, C_L = 100pF, SW = GND$ (Figure 3) (Note 16)	Full	-	152	250	ns
Driver Maximum Data Rate	$f_{MAX}$	$R_{DIFF} = 54\Omega, C_L = 100pF$ (Figure 2)	Full	-	30	-	Mbps
<b>RS-485 DRIVER SWITCHING CHARACTERISTICS (MEDIUM DATA RATE (460kbps), <math>485/232 = V_{CC}</math>, SLEW = <math>0V</math>, SPB = <math>V_{CC}</math> (QFN Only), ALL VERSIONS)</b>							
Driver Differential Input to Output Delay	$t_{DLH}, t_{DHL}$	$R_{DIFF} = 54\Omega, C_L = 100pF$ (Figure 2)	Full	200	490	1000	ns
Driver Output Skew	$t_{SKEW}$	$R_{DIFF} = 54\Omega, C_L = 100pF$ (Figure 2)	Full	-	110	400	ns
Driver Differential Rise or Fall Time	$t_R, t_F$	$R_{DIFF} = 54\Omega, C_L = 100pF$ (Figure 2)	Full	300	600	1100	ns
Driver Enable to Output Low	$t_{ZL}$	$C_L = 100pF, SW = V_{CC}$ (Figure 3)	Full	-	30	300	ns
Driver Enable to Output High	$t_{ZH}$	$C_L = 100pF, SW = GND$ (Figure 3)	Full	-	128	300	ns
Driver Disable from Output Low	$t_{LZ}$	$C_L = 15pF, SW = V_{CC}$ (Figure 3)	Full	-	31	60	ns
Driver Disable from Output High	$t_{HZ}$	$C_L = 15pF, SW = GND$ (Figure 3)	Full	-	24	60	ns
Driver Enable from Shutdown to Output Low	$t_{ZL(SHDN)}$	$R_L = 500\Omega, C_L = 100pF, SW = V_{CC}$ (Figure 3) (Note 16)	Full	-	65	500	ns
Driver Enable from Shutdown to Output High	$t_{ZH(SHDN)}$	$R_L = 500\Omega, C_L = 100pF, SW = GND$ (Figure 3) (Note 16)	Full	-	255	500	ns
Driver Maximum Data Rate	$f_{MAX}$	$R_{DIFF} = 54\Omega, C_L = 100pF$ (Figure 2)	Full	-	2000	-	kbps

**Electrical Specifications** Test Conditions:  $V_{CC} = 4.5V$  to  $5.5V$ ,  $C_1 - C_4 = 0.1\mu F$ ,  $V_L = V_{CC}$  (for QFN only), Unless Otherwise Specified. Typical values are at  $V_{CC} = 5V$ ,  $T_A = +25^\circ C$  (Note 10). (Continued)

PARAMETER	SYMBOL	TEST CONDITIONS	TEMP (°C)	MIN (Note 17)	TYP	MAX (Note 17)	UNITS	
<b>RS-485 DRIVER SWITCHING CHARACTERISTICS (SLOW DATA RATE (115kbps, QFN ONLY), <math>485/\overline{232} = V_{CC}</math>, SLEW = SPB = GND)</b>								
Driver Differential Input to Output Delay	$t_{DLH}, t_{DHL}$	$R_{DIFF} = 54\Omega$ , $C_L = 100pF$ (Figure 2)	Full	800	1500	2500	ns	
Driver Output Skew	$t_{SKEW}$	$R_{DIFF} = 54\Omega$ , $C_L = 100pF$ (Figure 2)	Full	-	350	1250	ns	
Driver Differential Rise or Fall Time	$t_R, t_F$	$R_{DIFF} = 54\Omega$ , $C_L = 100pF$ (Figure 2)	Full	1000	2000	3100	ns	
Driver Enable to Output Low	$t_{ZL}$	$C_L = 100pF$ , SW = $V_{CC}$ (Figure 3)	Full	-	32	600	ns	
Driver Enable to Output High	$t_{ZH}$	$C_L = 100pF$ , SW = GND (Figure 3)	Full	-	300	600	ns	
Driver Disable from Output Low	$t_{LZ}$	$C_L = 15pF$ , SW = $V_{CC}$ (Figure 3)	Full	-	31	60	ns	
Driver Disable from Output High	$t_{HZ}$	$C_L = 15pF$ , SW = GND (Figure 3)	Full	-	24	60	ns	
Driver Enable from Shutdown to Output Low	$t_{ZL(SHDN)}$	$R_L = 500\Omega$ , $C_L = 100pF$ , SW = $V_{CC}$ (Figure 3) (Note 16)	Full	-	65	800	ns	
Driver Enable from Shutdown to Output High	$t_{ZH(SHDN)}$	$R_L = 500\Omega$ , $C_L = 100pF$ , SW = GND (Figure 3) (Note 16)	Full	-	420	800	ns	
Driver Maximum Data Rate	$f_{MAX}$	$R_{DIFF} = 54\Omega$ , $C_L = 100pF$ (Figure 2)	Full	-	800	-	kbps	
<b>RS-485 RECEIVER SWITCHING CHARACTERISTICS (<math>485/\overline{232} = V_{CC}</math>, ALL VERSIONS AND SPEEDS)</b>								
Receiver Input to Output Delay	$t_{PLH}, t_{PHL}$	(Figure 4)	Full	20	50	90	ns	
Receiver Skew   $t_{PLH} - t_{PHL}$	$t_{SKEW}$	(Figure 4)	Full	-	3	10	ns	
Receiver Maximum Data Rate	$f_{MAX}$		Full	-	40	-	Mbps	
<b>RECEIVER ENABLE/DISABLE CHARACTERISTICS (ALL MODES AND VERSIONS AND SPEEDS)</b>								
Receiver Enable to Output Low	$t_{ZL}$	$C_L = 15pF$ , SW = $V_{CC}$ (Figure 5)	Full	-	22	60	ns	
Receiver Enable to Output High	$t_{ZH}$	$C_L = 15pF$ , SW = GND (Figure 5)	Full	-	23	60	ns	
Receiver Disable from Output Low	$t_{LZ}$	$C_L = 15pF$ , SW = $V_{CC}$ (Figure 5)	Full	-	24	60	ns	
Receiver Disable from Output High	$t_{HZ}$	$C_L = 15pF$ , SW = GND (Figure 5)	Full	-	25	60	ns	
Receiver Enable from Shutdown to Output Low	$t_{ZLSHDN}$	$C_L = 15pF$ , SW = $V_{CC}$ (Figure 5) (Note 16)	RS-485 Mode	Full	-	260	700	ns
			RS-232 Mode	25	-	35	-	ns
Receiver Enable from Shutdown to Output High	$t_{ZHSHDN}$	$C_L = 15pF$ , SW = GND (Figure 5) (Note 16)	RS-485 Mode	Full	-	260	700	ns
			RS-232 Mode	25	-	25	-	ns

## NOTES:

- All currents into device pins are positive; all currents out of device pins are negative. All voltages are referenced to device ground unless otherwise specified.
- Supply current specification is valid for loaded drivers when DEN = 0V.
- Applies to peak current. See "Typical Performance Curves" beginning on page 18 for more information.
- $R_{IN}$  defaults to RS-485 mode ( $>15k\Omega$ ) when the device is unpowered ( $V_{CC} = 0V$ ), or in SHDN, regardless of the state of the  $485/\overline{232}$  pin.
- $V_{CC} \leq 5.25V$ .
- The Slew pin has a pull-up resistor that enables only when in RS-485 mode ( $485/\overline{232} = V_{CC}$ ).
- ON, RXEN, and DEN all simultaneously switched Low-to-High.
- Parameters with MIN and/or MAX limits are 100% tested at  $+25^\circ C$ , unless otherwise specified. Temperature limits established by characterization and are not production tested.

# Test Circuits and Waveforms



FIGURE 1. RS-485 DRIVER  $V_{OD}$  AND  $V_{OC}$  TEST CIRCUIT



FIGURE 2A. TEST CIRCUIT

FIGURE 2. RS-485 DRIVER PROPAGATION DELAY AND DIFFERENTIAL TRANSITION TIMES



$$\text{SKEW} = |t_{PLH}(\text{Y OR Z}) - t_{PHL}(\text{Z OR Y})|$$

FIGURE 2B. MEASUREMENT POINTS



FOR SHDN TESTS, SWITCH ON AND DEN L- H SIMULTANEOUSLY

PARAMETER	OUTPUT	RXEN	DY	SW	CL (pF)
$t_{HZ}$	Y/Z	X	0/1	GND	15
$t_{LZ}$	Y/Z	X	1/0	$V_{CC}$	15
$t_{ZH}$	Y/Z	X	0/1	GND	100
$t_{ZL}$	Y/Z	X	1/0	$V_{CC}$	100
$t_{ZH}(\text{SHDN})$	Y/Z	0	0/1	GND	100
$t_{ZL}(\text{SHDN})$	Y/Z	0	1/0	$V_{CC}$	100

FIGURE 3A. TEST CIRCUIT

FIGURE 3. RS-485 DRIVER ENABLE AND DISABLE TIMES



FIGURE 3B. MEASUREMENT POINTS

## Test Circuits and Waveforms (Continued)



FIGURE 4A. TEST CIRCUIT

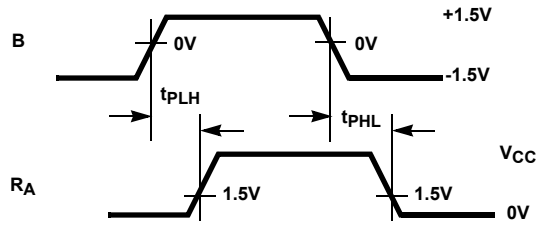
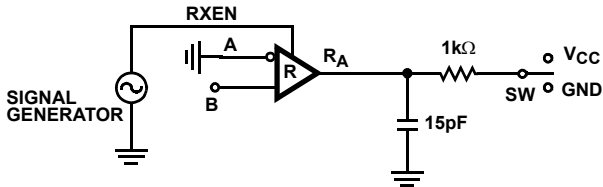

FIGURE 4B. MEASUREMENT POINTS

FIGURE 4. RS-485 RECEIVER PROPAGATION DELAY



FOR SHDN TESTS, SWITCH ON AND RXEN L-H SIMULTANEOUSLY

PARAMETER	DEN	B	SW
$t_{HZ}$	X	+1.5V	GND
$t_{LZ}$	X	-1.5V	$V_{CC}$
$t_{ZH}$	X	+1.5V	GND
$t_{ZL}$	X	-1.5V	$V_{CC}$
$t_{ZH(SHDN)}$	0	+1.5V	GND
$t_{ZL(SHDN)}$	0	-1.5V	$V_{CC}$

FIGURE 5A. TEST CIRCUIT

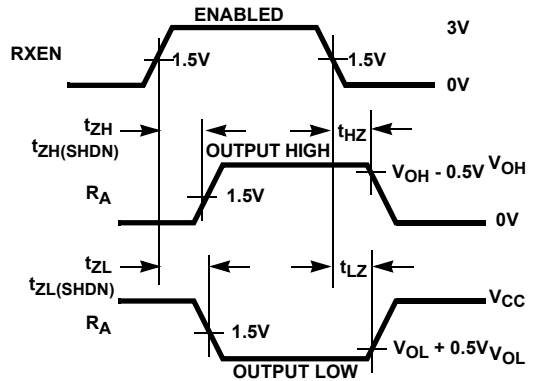

FIGURE 5B. MEASUREMENT POINTS

FIGURE 5. RS-485 RECEIVER ENABLE AND DISABLE TIMES



FIGURE 6A. TEST CIRCUIT



FIGURE 6B. MEASUREMENT POINTS

FIGURE 6. RS-232 DRIVER PROPAGATION DELAY



FIGURE 7A. TEST CIRCUIT



FIGURE 7B. MEASUREMENT POINTS

FIGURE 7. RS-232 RECEIVER PROPAGATION DELAY

## Detailed Description

The ISL81387, ISL41387 port supports dual protocols: RS-485, RS-422, and RS-232. RS-485 and RS-422 are differential (balanced) data transmission standards for use in high speed (up to 20Mbps) networks, or long haul and noisy environments. The differential signalling, coupled with RS-485's requirement for extended common mode range (CMR) of +12V to -7V make these transceivers extremely tolerant of ground potential differences, as well as voltages induced in the cable by external fields. Both of these effects are real concerns when communicating over the RS-485, RS-422 maximum distance of 4000' (1220m). **It is important to note that the ISL81387, ISL41387 don't follow the RS-485 convention whereby the inverting I/O is labelled "B/Z", and the non-inverting I/O is "A/Y". Thus, in the following application diagrams, the ISL81387, ISL41387 A/Y (B/Z) pins connect to the B/Z (A/Y) pins of the generic RS-485, RS-422 ICs.**

RS-422 is typically a point-to-point (one driver talking to one receiver on a bus), or a point-to-multipoint (multidrop) standard that allows only one driver and up to 10 receivers on each bus.

Because of the one driver per bus limitation, RS-422 networks use a two bus, full duplex structure for bidirectional communication, and the Rx inputs and Tx outputs (no tri-state required) connect to different busses, as shown in Figure 9. Tx and Rx enables aren't required, so connect RXEN and DEN to V<sub>CC</sub> through a 1kΩ resistor.

Conversely, RS-485 is a true multipoint standard, which allows up to 32 devices (any combination of drivers- must be tri-statable - and receivers) on each bus. Now bidirectional communication takes place on a single bus, so the Rx inputs and Tx outputs of a port connect to the same bus lines, as shown in Figure 8. A port set to RS-485, RS-422 mode includes one Rx and one Tx. See application note AN1378 for details on implementing a three pin, selectable RS-232/ half duplex RS-485 port.

RS-232 is a point-to-point, singled ended (signal voltages referenced to GND) communication protocol targeting fairly short (<150', 46m) and low data rate (<1Mbps) applications. A port contains two transceivers (2 Tx and 2 Rx) in RS-232 mode.

Protocol selection is handled via the 485/232 logic pin.



FIGURE 8. TYPICAL HALF DUPLEX RS-485 NETWORK

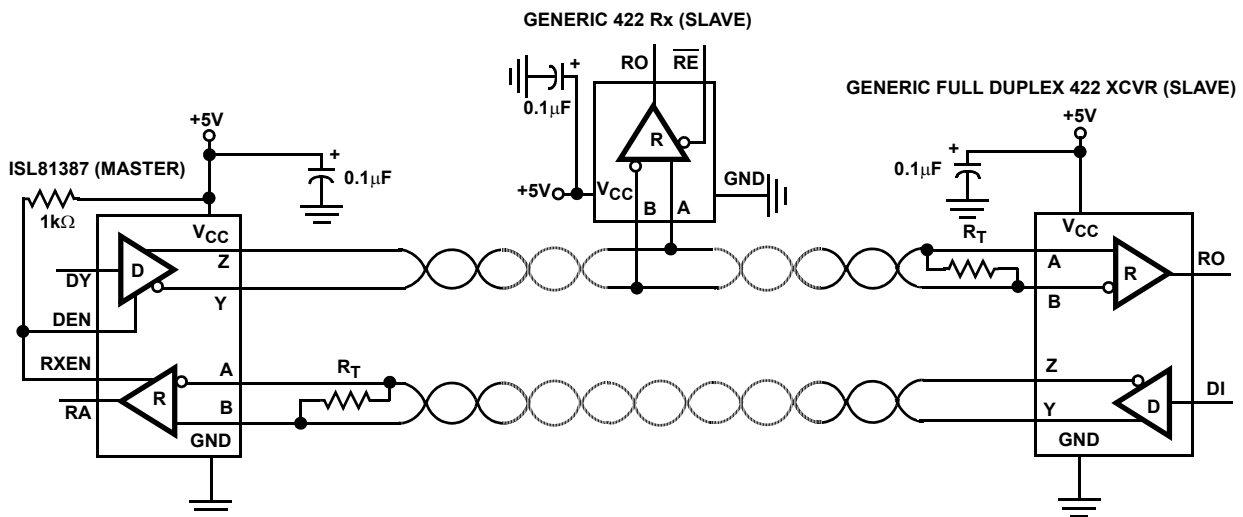

FIGURE 9. TYPICAL RS-422 NETWORK

## ISL81387, ISL41387 Advantages

These dual protocol ICs offer many parametric improvements versus those offered on competing dual protocol devices. Some of the major improvements are:

- 15kV Bus Pin ESD - Eases board level requirements
- 2.7V Diff  $V_{OUT}$  - Better Noise immunity and/or distance
- Full fail-safe RS-485 Rx - Eliminates bus biasing
- Selectable RS-485 Data Rate - Up to 20Mbps, or slewrate limited for low EMI and fewer termination issues
- High RS-232 Data Rate - >460kbps
- Lower Tx and Rx Skews - Wider, consistent bit widths
- Lower  $I_{CC}$  - Max  $I_{CC}$  is 2x to 4x lower than competition
- Flow-Thru Pinouts - Tx, Rx bus pins on one side/logic pins on the other, for easy routing to connector/UART
- Smaller (SSOP and QFN) and Pb-free packaging

## RS-232 Mode

### RX FEATURES

RS-232 receivers invert and convert RS-232 input levels ( $\pm 3V$  to  $\pm 25V$ ) to the standard TTL/CMOS levels required by a UART, ASIC, or  $\mu$ controller serial port. Receivers are designed to operate at faster data rates than the drivers, and they feature very low skews (10ns) so the receivers contribute negligibly to bit width distortion. Inputs include the standard required  $3k\Omega$  to  $7k\Omega$  pull-down resistor, so unused inputs may be left unconnected. Rx inputs also have built-in hysteresis to increase noise immunity, and to decrease erroneous triggering due to slowly transitioning input signals.

Rx outputs are short circuit protected, and are tri-statable via the active high  $R_{XEN}$  pin, when the IC is shutdown (SHDN; see [Tables 2 and 3](#), and [“Low Power Shutdown \(SHDN\) Mode” on page 16](#)), or via the active low  $\overline{R_{XEN}}$  pin available on the QFN package option (see [“ISL41387 \(QFN Package\) Special Features” on page 17](#) for more details).

### TX FEATURES

RS-232 drivers invert and convert the standard TTL/CMOS levels from a UART, or  $\mu$ controller serial port to RS-232 compliant levels ( $\pm 5V$  minimum). The Tx delivers these compliant output levels even at data rates of 650kbps, and with loads of 1000pF. The drivers are designed for low skew (typically 12% of the 500kbps bit width), and are compliant to the RS-232 slew rate spec ( $4V/\mu s$  to  $30V/\mu s$ ) for a wide range of load capacitances. Tx inputs float if left unconnected, and may cause  $I_{CC}$  increases. For the best results, connect unused inputs to GND.

Tx outputs are short circuit protected, and incorporate a thermal SHDN feature to protect the IC in situations of severe power dissipation. See the RS-485 section for more details. Drivers tri-state via the active high DEN pin, in SHDN (see [Tables 2 and 3](#), and [“Low Power Shutdown \(SHDN\) Mode” on page 16](#)), or when the 5V power supply is off.

## CHARGE PUMPS

The on-chip charge pumps create the RS-232 transmitter power supplies (typically  $+6/-7V$ ) from a single supply as low as 4.5V, and are enabled only if the port is configured for RS-232 operation, and not in SHDN. The efficient design requires only four small 0.1 $\mu$ F capacitors for the voltage doubler and inverter functions. By operating discontinuously (i.e., turning off as soon as V+ and V- pump up to the nominal values), the charge pump contribution to RS-232 mode  $I_{CC}$  is reduced significantly. Unlike competing devices that require the charge pump in RS-485 mode, disabling the charge pump saves power, and minimizes noise. If the application is a dedicated RS-485 port, then the charge pump capacitors aren't even required.

## DATA RATES AND CABLING

Drivers operate at data rates up to 650kbps, and are guaranteed for data rates up to 460kbps. The charge pumps and drivers are designed such that one driver can be operated at the rated load, and at 460kbps (see [Figure 33](#)). [Figure 33](#) also shows that drivers can easily drive several thousands of picofarads at data rates up to 250kbps, while still delivering compliant  $\pm 5V$  output levels.

Receivers operate at data rates up to 2Mbps. They are designed for a higher data rate to facilitate faster factory downloading of software into the final product, thereby improving the user's manufacturing throughput.

[Figures 36](#) and [37](#) illustrate driver and receiver waveforms at 250kbps, and 500kbps, respectively. For these graphs, one driver drives the specified capacitive load, and a receiver.

RS-232 doesn't require anything special for cabling; just a single bus wire per transmitter and receiver, and another wire for GND. So an ISL81387, ISL41387 RS-232 port uses a five conductor cable for interconnection. Bus terminations are not required, nor allowed, by the RS-232 standard.

## RS-485 Mode

### RX FEATURES

RS-485 receivers convert differential input signals as small as 200mV, as required by the RS-485 and RS-422 standards, to TTL/CMOS output levels. The differential Rx provides maximum sensitivity, noise immunity, and common mode rejection. Per the RS-485 standard, receiver inputs function with common mode voltages as great as  $\pm 7V$  outside the power supplies (i.e.,  $+12V$  and  $-7V$ ), making them ideal for long networks where induced voltages are a realistic concern. Each RS-485, RS-422 port includes a single receiver (RA), and the unused Rx output (RB) is disabled.

Worst case receiver input currents are 20% lower than the 1 “unit load” (1mA) RS-485 limit, which translates to a 15k $\Omega$  minimum input resistance.

These receivers include a “full fail-safe” function that guarantees a high level receiver output if the receiver inputs are unconnected (floating), shorted together, or if the bus is terminated but undriven (i.e., differential voltage collapses to near zero due to termination). Fail-safe with shorted, or terminated and undriven inputs is accomplished by setting the Rx upper switching point at

-40mV, thereby ensuring that the Rx recognizes a 0V differential as a high level.

All the Rx outputs are short circuit protected, and are tri-statable via the active high RXEN pin, or when the IC is shutdown (see [Tables 2 and 3](#), and [“Low Power Shutdown \(SHDN\) Mode” on page 16](#)). ISL41387 (QFN) receiver outputs are also tri-statable via an active low RXEN input (see [“ISL41387 \(QFN Package\) Special Features” on page 17](#) for more details).

For the ISL41387 (QFN), when using the active high RXEN function, the RXEN pin may be left floating (internally pulled high), or should be connected to V<sub>CC</sub> through a 1kΩ resistor. If using the active low RXEN, then the RXEN pin must be connected to GND.

## TX FEATURES

The RS-485, RS-422 driver is a differential output device that delivers at least 2.2V across a 54Ω load (RS-485), and at least 2.5V across a 100Ω load (RS-422). Both levels significantly exceed the standards requirements, and these exceptional output voltages increase system noise immunity, and/or allow for transmission over longer distances. The drivers feature low propagation delay skew to maximize bit widths, and to minimize EMI.

To allow multiple drivers on a bus, the RS-485 specification requires that drivers survive worst case bus contentions undamaged. The ISL81387, ISL41387 drivers meet this requirement via driver output short circuit current limits, and on-chip thermal shutdown circuitry. The output stages incorporate current limiting circuitry that ensures that the output current never exceeds the RS-485 specification, even at the common mode voltage range extremes. In the event of a major short circuit condition, devices also include a thermal shutdown feature that disables the drivers whenever the die temperature becomes excessive. This eliminates the power dissipation, allowing the die to cool. The drivers automatically re-enable after the die temperature drops about 15°. If the contention persists, the thermal shutdown/re-enable cycle repeats until the fault is cleared. Receivers stay operational during thermal shutdown.

RS-485 multi-driver operation also requires drivers to include tri-state functionality, so the port has a DEN pin to control this function. If the driver is used in an RS-422 network, such that driver tri-state isn't required, then the DEN pin should connect to V<sub>CC</sub> through a 1kΩ resistor. Drivers are also tri-stated when the IC is in SHDN, or when the 5V power supply is off.

## SPEED OPTIONS

The ISL81387 (SOIC/SSOP) features two speed options that are user selectable via the SLEW pin: a high slew rate setting optimized for 20Mbps data rates (Fast), and a slew rate limited option for operation up to 460kbps (Med). The ISL41387 (QFN) offers an additional, more slew rate limited, option for data rates up to 115kbps (Slow). See [“Data Rate, Cables and Terminations” on page 15](#) and [“RS-485 Slew Rate Limited Data Rates” on page 17](#) for more information.

Receiver performance is the same for all three speed options.

## DATA RATE, CABLES AND TERMINATIONS

RS-485, RS-422 are intended for network lengths up to 4000' (1220m), but the maximum system data rate decreases as the transmission length increases. Devices operating at the maximum data rate of 20Mbps are limited to lengths of 20' to 30' (6m to 9m), while devices operating at or below 115kbps can operate at the maximum length of 4000' (1220m).

Higher data rates require faster edges, so both the ISL81387, ISL41387 versions offer an edge rate capable of 20Mbps data rates. They both have a second option for 460kbps, but the ISL41387 also offers another, very slew rate limited, edge rate to minimize problems at slow data rates. Nevertheless, for the best jitter performance when driving long cables, the faster speed settings may be preferable, even at low data rates. See [“RS-485 Slew Rate Limited Data Rates” on page 17](#) for details.

Twisted pair is the cable of choice for RS-485, RS-422 networks. Twisted pair cables tend to pick up noise and other electromagnetically induced voltages as common mode signals, which are effectively rejected by the differential receivers in these ICs.

The preferred cable connection technique is “daisy-chaining”, where the cable runs from the connector of one device directly to the connector of the next device, such that cable stub lengths are negligible. A “backbone” structure, where stubs run from the main backbone cable to each device's connector, is the next best choice, but care must be taken to ensure that each stub is electrically “short”. See [Table 4](#) for recommended maximum stub lengths for each speed option.

TABLE 4. RECOMMENDED STUB LENGTHS

SPEED OPTION	MAXIMUM STUB LENGTH ft (m)
SLOW	350 to 500 (107 to 152)
MED	100 to 150 (30.5 to 46)
FAST	1 to 3 (0.3 to 0.9)

Proper termination is imperative to minimize reflections when using the 20Mbps speed option. Short networks using the medium and slow speed options need not be terminated, but terminations are recommended unless power dissipation is an overriding concern. Note that the RS-485 specification allows a maximum of two terminations on a network, otherwise the Tx output voltage may not meet the required V<sub>OD</sub>.

In point-to-point, or point-to-multipoint (RS-422) networks, the main cable should be terminated in its characteristic impedance (typically 120Ω) at the end farthest from the driver. In multi-receiver applications, stubs connecting receivers to the main cable should be kept as short as possible, but definitely shorter than the limits shown in [Table 4](#). Multipoint (RS-485) systems require that the main cable be terminated in its characteristic impedance at both ends. Again, keep stubs connecting a transceiver to the main cable as short as possible, and refer to [Table 4](#). Avoid “star”, and other configurations, where there are many “ends” which would require more than the two allowed terminations to prevent reflections.

## High ESD

All pins on the ISL81387, ISL41387 include ESD protection structures rated at  $\pm 4\text{kV}$  (HBM), which is good enough to survive ESD events commonly seen during manufacturing. But the bus pins (Tx outputs and Rx inputs) are particularly vulnerable to ESD events because they connect to an exposed port on the exterior of the finished product. Simply touching the port pins, or connecting a cable, can destroy an unprotected port. ISL81387, ISL41387 bus pins are fitted with advanced structures that deliver ESD protection in excess of  $\pm 15\text{kV}$  (HBM), without interfering with any signal in the RS-485 or the RS-232 range. This high level of protection may eliminate the need for board level protection, or at the very least will increase the robustness of any board level scheme.

## Small Packages

Many competing dual protocol ICs are available only in monstrously large 24 to 28 Ld SOIC packages. The ISL81387's 20 Ld SSOP is more than 50% smaller than even a 24 Ld SOIC, and the ISL41387's tiny 6mmx6mm QFN is 80% smaller than a 28 Ld SOIC.

## Flow-Through Pinouts

Even the ISL81387, ISL41387 pinouts are features, in that the "flow-through" design simplifies board layout. Having the bus pins all on one side of the package for easy routing to a cable connector, and the Rx outputs and Tx inputs on the other side for easy connection to a UART, avoids costly and problematic crossovers. [Figure 10](#) illustrates the flow-through nature of the pinout.



FIGURE 10. ILLUSTRATION OF FLOW-THROUGH PINOUT

## Low Power Shutdown (SHDN) Mode

The ISL81387, ISL41387 enter the SHDN mode when  $ON = 0$ , and the Tx and Rx are disabled ( $DEN = 0$ ,  $R Xen = 0$ , and  $\overline{RXEN} = 1$ ), and the already low supply current drops to as low as  $5\mu\text{A}$ . SHDN disables the Tx and Rx outputs, and disables the charge pumps if the port is in RS-232 mode, so  $V+$  collapses to  $V_{CC}$ , and  $V-$  collapses to GND.

All but  $5\mu\text{A}$  of SHDN  $I_{CC}$  current is due to control input (SPB, SLEW) pull-up resistors ( $\sim 20\mu\text{A}/\text{resistor}$ ), so SHDN  $I_{CC}$  varies depending on the ISL81387, ISL41387 configuration. The specification tables indicate the worst case values, but careful selection of the configuration yields lower currents. For example, in RS-232 mode the SPB pin isn't used, so floating it or tying it high minimizes SHDN  $I_{CC}$ .

On the ISL41387, the SHDN  $I_{CC}$  increases as  $V_L$  decreases.  $V_L$  powers each control pin input stage and sets its  $V_{OH}$  at  $V_L$  rather than  $V_{CC}$ .  $V_{CC}$  powers the second stage, but the second stage input isn't driven to the rail, so some  $I_{CC}$  current flows. See [Figure 20](#) for details.

When enabling from SHDN in RS-232 mode, allow at least  $20\mu\text{s}$  for the charge pumps to stabilize before transmitting data. If fast enables are required, and  $I_{CC}$  isn't the greatest concern, disable the drivers with the DEN pin to keep the charge pumps active. The charge pumps aren't used in RS-485 mode, so the transceiver is ready to send or receive data in less than  $1\mu\text{s}$ , which is much faster than competing devices that require the charge pump for all modes of operation.

## Internal Loopback Mode

Setting  $ON = 0$ ,  $DEN = 1$ , and  $R Xen = 1$  or  $\overline{RXEN} = 0$  (QFN only), places the port in the loopback mode, a mode that facilitates implementing board level self test functions. In loopback, internal switches disconnect the Rx inputs from the Rx outputs, and feed back the Tx outputs to the appropriate Rx output. This way the data driven at the Tx input appears at the corresponding Rx output (refer to ["Typical Operating Circuit" on page 6](#)). The Tx outputs remain connected to their terminals, so the external loads are reflected in the loopback performance. This allows the loopback function to potentially detect some common bus faults such as one or both driver outputs shorted to GND, or outputs shorted together.

Note that the loopback mode uses an additional set of receivers, as shown in ["Typical Operating Circuit" on page 6](#). These loopback receivers are not standards compliant, so the loopback mode can't be used to implement a half-duplex RS-485 transceiver. See application note [AN1378](#) for specific details on implementing a three pin, half duplex dual protocol port.



# ISL41387 (QFN Package) Special Features

## Logic Supply (V<sub>L</sub> Pin)

The ISL41387 (QFN) includes a V<sub>L</sub> pin that powers the logic inputs (Tx inputs and control pins) and Rx outputs. These pins interface with “logic” devices such as UARTs, ASICs, and μcontrollers, and today most of these devices use power supplies significantly lower than 5V. Thus, a 5V output level from a 5V powered dual protocol IC might seriously overdrive and damage the logic device input. Similarly, the logic device’s low V<sub>OH</sub> might not exceed the V<sub>IH</sub> of a 5V powered dual protocol input. Connecting the V<sub>L</sub> pin to the power supply of the logic device (as shown in Figure 11) limits the ISL41387’s Rx output V<sub>OH</sub> to V<sub>L</sub> (see Figure 14), and reduces the Tx and control input switching points to values compatible with the logic device output levels. Tailoring the logic pin input switching points and output levels to the supply voltage of the UART, ASIC, or μcontroller eliminates the need for a level shifter/translator between the two ICs.

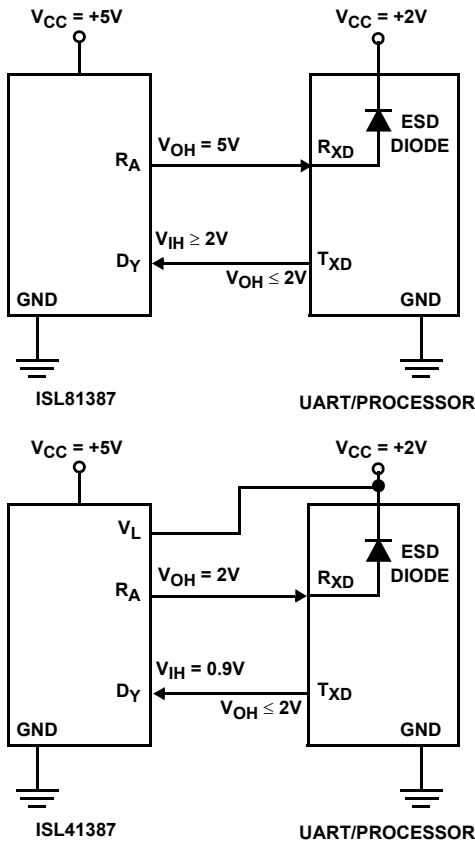

FIGURE 11. USING V<sub>L</sub> PIN TO ADJUST LOGIC LEVELS

V<sub>L</sub> can be anywhere from V<sub>CC</sub> down to 1.65V, but the input switching points may not provide enough noise margin when V<sub>L</sub> < 1.8V. Table 5 indicates typical V<sub>IH</sub> and V<sub>IL</sub> values for various

V<sub>L</sub> values so the user can ascertain whether or not a particular V<sub>L</sub> voltage meets his or her needs.

TABLE 5. V<sub>IH</sub> AND V<sub>IL</sub> vs V<sub>L</sub> FOR V<sub>CC</sub> = 5V

V <sub>L</sub> (V)	V <sub>IH</sub> (V)	V <sub>IL</sub> (V)
1.65V	0.79	0.50
1.8V	0.82	0.60
2.0V	0.87	0.69
2.5V	0.99	0.86
3.3V	1.19	1.05

The V<sub>L</sub> supply current (I<sub>L</sub>) is typically less than 60μA, as shown in Figures 19 and 20. All of the DC V<sub>L</sub> current is due to inputs with internal pull-up resistors (SPB, SLEW, RXEN) being driven to the low input state. The worst case I<sub>L</sub> current occurs when all three of the inputs are low (see Figure 19), due to the I<sub>L</sub> through the pull-up resistors. I<sub>IL</sub> through an input pull-up resistor is ~20μA, so the I<sub>L</sub> in Figure 19 drops by about 40μA (at V<sub>L</sub> = 5V) when the SPB is high and 232 mode disables the SLEW pin pull-up (middle vs top curve). When all three inputs are driven high, I<sub>L</sub> drops to ~10nA, so to minimize power dissipation drive these inputs high when unneeded (e.g., SPB isn’t used in RS-232 mode, so drive it high).

## Active Low Rx Enable (RXEN)

In many RS-485 applications, especially half duplex configurations, users like to accomplish “echo cancellation” by disabling the corresponding receiver while its driver is transmitting data. This function is available on the QFN package via an active low RXEN pin. The active low function also simplifies direction control, by allowing a single Tx/Rx direction control line. If the active high RXEN were used, either two valuable I/O pins would be used for direction control, or an external inverter is required between DEN and RXEN. Figure 12 details the advantage of using the RXEN pin. When using RXEN, ensure that RXEN is tied to GND.

## RS-485 Slew Rate Limited Data Rates

The ISL81387, ISL41387 FAST speed option (SLEW = High) utilizes Tx output transitions optimized for a 20Mbps data rate. These fast edges may increase EMI and reflection issues, even though fast transitions aren’t required at the lower data rates used by many applications. With the SLEW pin low, both product types switch to a moderately slew rate limited output transition targeted for 460kbps (MED) data rates. The ISL41387 (QFN version) offers an additional, slew rate limited data rate that is optimized for 115kbps (SLOW), and is selected when SLEW = 0 and SPB = 0 (see Table 3). The slew limited edges permit longer unterminated networks, or longer stubs off terminated busses, and help minimize EMI and reflections. Nevertheless, for the best jitter performance when driving long cables, the faster speed options may be preferable, even at lower data rates. The faster output transitions deliver less variability (jitter) when loaded with the large capacitance associated with long cables. Figures 42, 43, and 44 detail the jitter performance of the three speed options while driving three different cable lengths. The figures show that under all conditions the faster the edge rate, the better

the jitter performance. Of course, faster transitions require more attention to ensuring short stub lengths, and quality terminations, so there are trade-offs to be made. Assuming a jitter budget of 10%, it is likely better to go with the slow speed option for data rates of 115kbps or less, to minimize fast edge effects. Likewise, the medium speed option is a good choice for data rates between 115kbps and 460kbps. For higher data rates, or when the absolute best jitter is required, use the high speed option.

## Evaluation Board

An evaluation board, part number ISL41387EVAL1, is available to assist in assessing the dual protocol IC's performance. The evaluation board contains a QFN packaged device, but because the same die is used in all packages, the board is also useful for evaluating the functionality of the other versions. The board's design allows for evaluation of all standard features, plus the QFN specific features. Refer to the evaluation board application note for details and contact your sales rep for ordering information.



FIGURE 12. USING ACTIVE LOW vs ACTIVE HIGH RX ENABLE

## Typical Performance Curves

$V_{CC} = V_L = 5V$ ,  $T_A = +25^\circ C$ ; Unless Otherwise Specified.

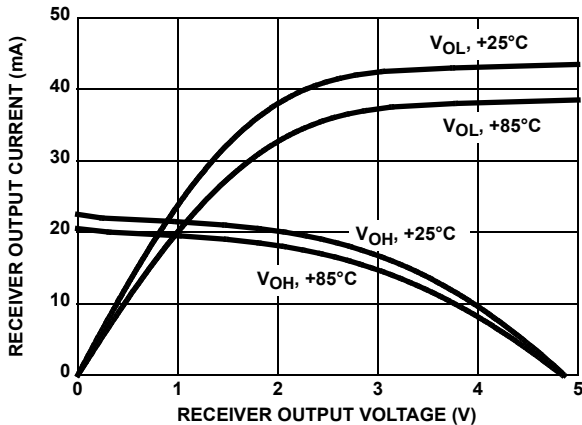

FIGURE 13. RECEIVER OUTPUT CURRENT vs RECEIVER OUTPUT VOLTAGE

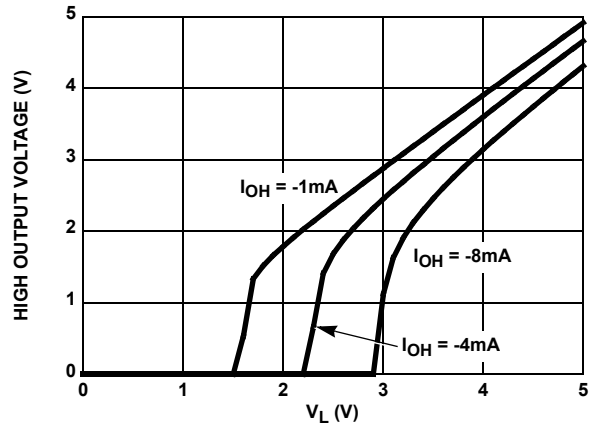

FIGURE 14. RECEIVER HIGH OUTPUT VOLTAGE vs LOGIC SUPPLY VOLTAGE ( $V_L$ ) (QFN ONLY)

**Typical Performance Curves**  $V_{CC} = V_L = 5V, T_A = +25^\circ C$ ; Unless Otherwise Specified. (Continued)



FIGURE 15. RS-485, DRIVER OUTPUT CURRENT vs DIFFERENTIAL OUTPUT VOLTAGE



FIGURE 16. RS-485, DRIVER DIFFERENTIAL OUTPUT VOLTAGE vs TEMPERATURE



FIGURE 17. RS-485, DRIVER OUTPUT CURRENT vs SHORT CIRCUIT VOLTAGE



FIGURE 18. SUPPLY CURRENT vs TEMPERATURE



FIGURE 19.  $V_L$  SUPPLY CURRENT vs  $V_L$  VOLTAGE (QFN ONLY)



FIGURE 20.  $V_{CC}$  AND  $V_L$  SHDN SUPPLY CURRENTS vs  $V_L$  VOLTAGE (QFN ONLY)

**Typical Performance Curves**  $V_{CC} = V_L = 5V, T_A = +25^\circ C$ ; Unless Otherwise Specified. (Continued)



FIGURE 21. RS-485, DRIVER PROPAGATION DELAY vs TEMPERATURE (SLOW DATA RATE, QFN ONLY)



FIGURE 22. RS-485, DRIVER SKEW vs TEMPERATURE (SLOW DATA RATE, QFN ONLY)



FIGURE 23. RS-485, DRIVER PROPAGATION DELAY vs TEMPERATURE (MEDIUM DATA RATE)



FIGURE 24. RS-485, DRIVER SKEW vs TEMPERATURE (MEDIUM DATA RATE)



FIGURE 25. RS-485, DRIVER PROPAGATION DELAY vs TEMPERATURE (FAST DATA RATE)

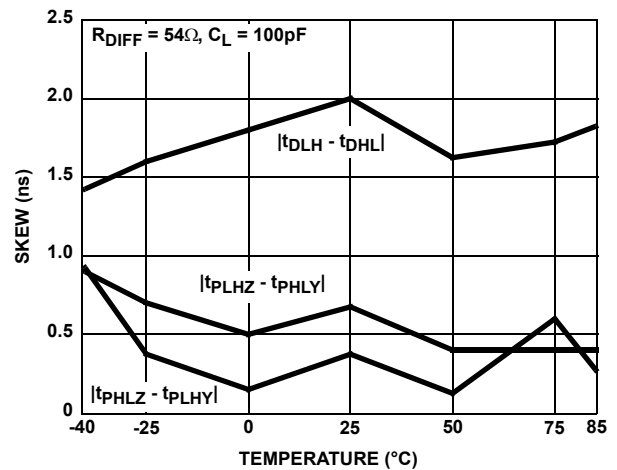

FIGURE 26. RS-485, DRIVER SKEW vs TEMPERATURE (FAST DATA RATE)

**Typical Performance Curves**  $V_{CC} = V_L = 5V, T_A = +25^\circ C$ ; Unless Otherwise Specified. (Continued)

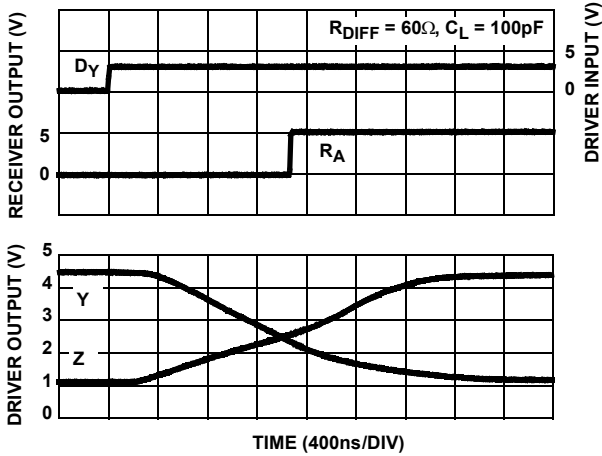

FIGURE 27. RS-485, DRIVER AND RECEIVER WAVEFORMS, LOW TO HIGH (SLOW DATA RATE, QFN ONLY)



FIGURE 28. RS-485, DRIVER AND RECEIVER WAVEFORMS, HIGH TO LOW (SLOW DATA RATE, QFN ONLY)

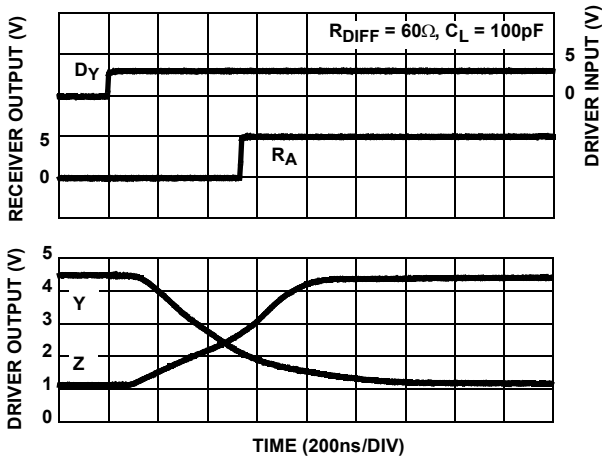

FIGURE 29. RS-485, DRIVER AND RECEIVER WAVEFORMS, LOW TO HIGH (MEDIUM DATA RATE)



FIGURE 30. RS-485, DRIVER AND RECEIVER WAVEFORMS, HIGH TO LOW (MEDIUM DATA RATE)

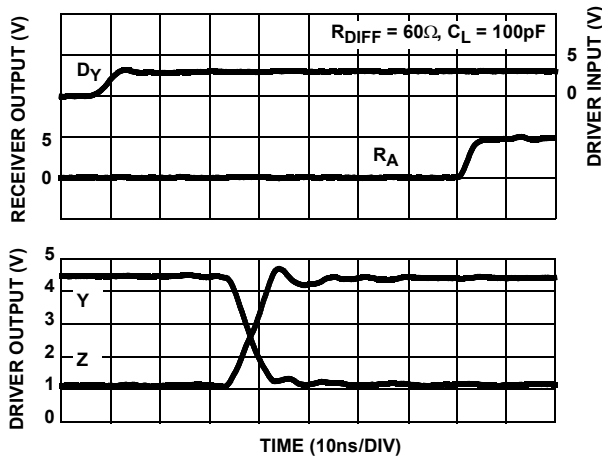

FIGURE 31. RS-485, DRIVER AND RECEIVER WAVEFORMS, LOW TO HIGH (FAST DATA RATE)



FIGURE 32. RS-485, DRIVER AND RECEIVER WAVEFORMS, HIGH TO LOW (FAST DATA RATE)

**Typical Performance Curves**  $V_{CC} = V_L = 5V, T_A = +25^\circ C$ ; Unless Otherwise Specified. (Continued)



FIGURE 33. RS-232, TRANSMITTER OUTPUT VOLTAGE vs LOAD CAPACITANCE

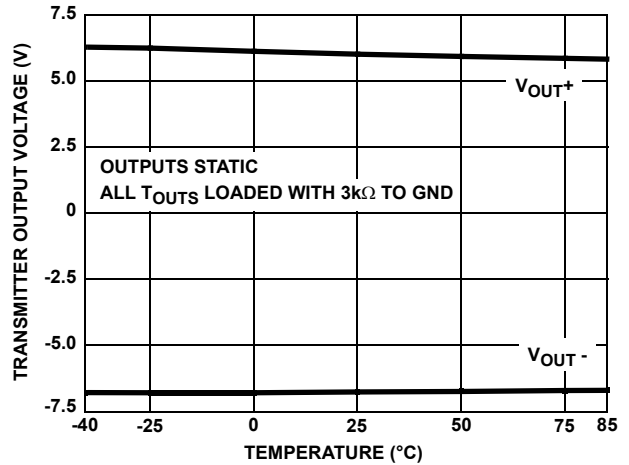

FIGURE 34. RS-232, TRANSMITTER OUTPUT VOLTAGE vs TEMPERATURE



FIGURE 35. RS-232, TRANSMITTER SHORT CIRCUIT CURRENT vs TEMPERATURE

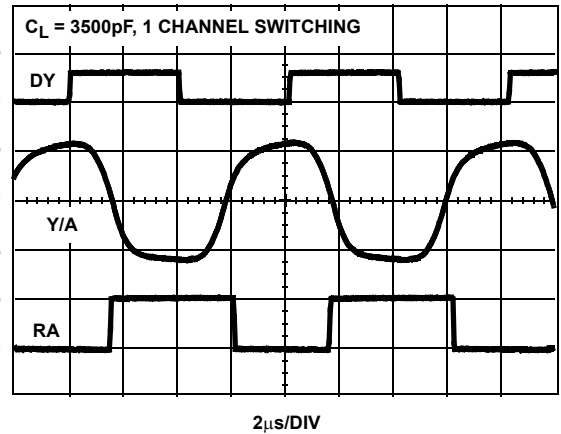

FIGURE 36. RS-232, TRANSMITTER AND RECEIVER WAVEFORMS AT 250kbps



FIGURE 37. RS-232, TRANSMITTER AND RECEIVER WAVEFORMS AT 500kbps

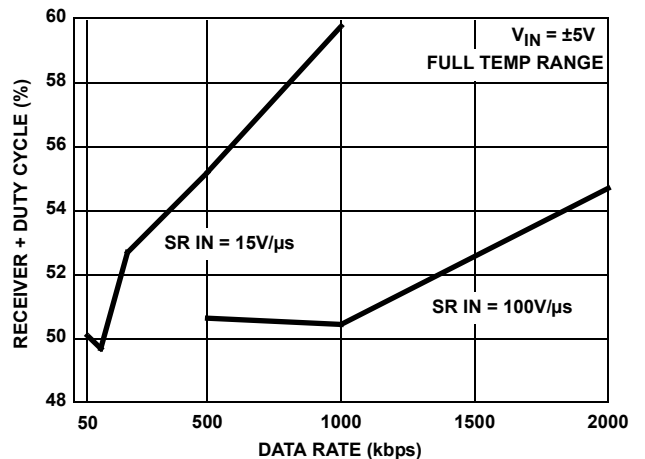

FIGURE 38. RS-232, RECEIVER OUTPUT + DUTY CYCLE vs DATA RATE

**Typical Performance Curves**  $V_{CC} = V_L = 5V, T_A = +25^\circ C$ ; Unless Otherwise Specified. (Continued)

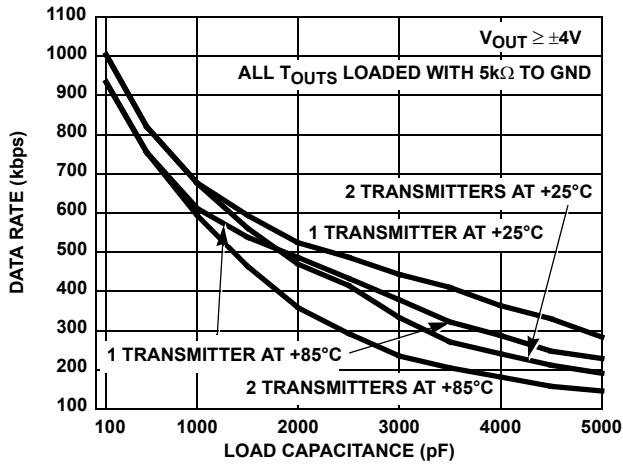

FIGURE 39. RS-232, TRANSMITTER MAXIMUM DATA RATE vs LOAD CAPACITANCE



FIGURE 40. RS-232, TRANSMITTER OUTPUT VOLTAGE vs DATA RATE

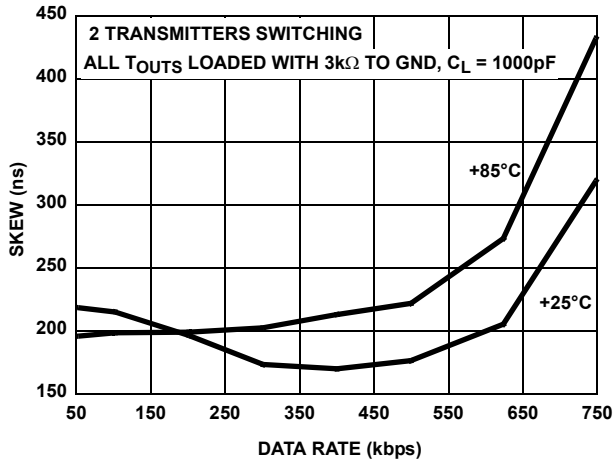

FIGURE 41. RS-232, TRANSMITTER SKEW vs DATA RATE



FIGURE 42. RS-485, TRANSMITTER JITTER vs DATA RATE WITH 2000' CAT-5 CABLE

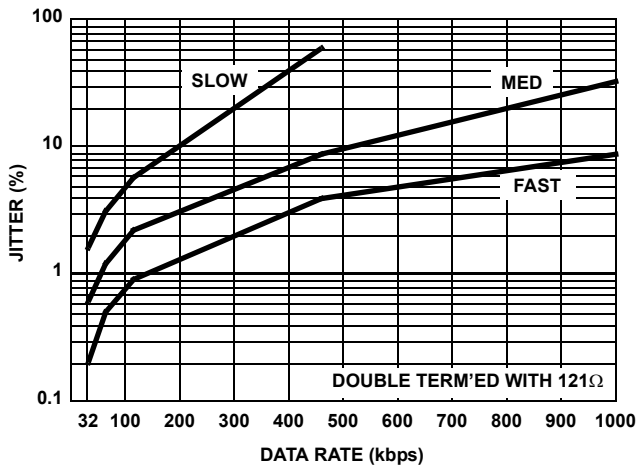

FIGURE 43. RS-485, TRANSMITTER JITTER vs DATA RATE WITH 1000' CAT-5 CABLE

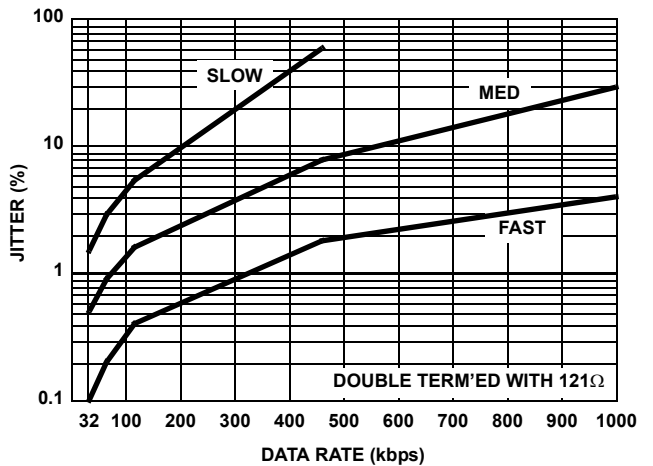

FIGURE 44. RS-485, TRANSMITTER JITTER vs DATA RATE WITH 350' CAT-5 CABLE

## Die Characteristics

### SUBSTRATE AND QFN THERMAL PAD POTENTIAL (POWERED UP):

GND

### TRANSISTOR COUNT:

2490

### PROCESS:

BiCMOS

## Revision History

The revision history provided is for informational purposes only and is believed to be accurate, but not warranted. Please go to the web to make sure that you have the latest revision.

DATE	REVISION	CHANGE
May 12, 2014	FN6201.4	<p>Reformatted entire datasheet to Intersil latest template. Added Revision History</p> <p>Page 1:</p> <ul style="list-style-type: none"> <li>- Changed 20<math>\mu</math>A to 35<math>\mu</math>A in paragraph 4.</li> <li>- Added Related Literature</li> </ul> <p>Updated <a href="#">Note 17</a></p> <p><a href="#">Figure 14</a> added QFN ONLY to figure name.</p> <p><a href="#">Figure 19</a> Removed RS-232 from figure name.</p> <p><a href="#">Figure 20</a> Changed Y-axis units from mA to <math>\mu</math>A.</p> <p><a href="#">Figures 23, 24, 29, and 30</a> removed QFN ONLY from the Figure name.</p> <p>Replaced POD on <a href="#">page 26</a> to latest revision.</p>

## About Intersil

Intersil Corporation is a leading provider of innovative power management and precision analog solutions. The company's products address some of the largest markets within the industrial and infrastructure, mobile computing and high-end consumer markets.

For the most updated datasheet, application notes, related documentation and related parts, please see the respective product information page found at [www.intersil.com](http://www.intersil.com).

You may report errors or suggestions for improving this datasheet by visiting [www.intersil.com/ask](http://www.intersil.com/ask).

Reliability reports are also available from our website at [www.intersil.com/support](http://www.intersil.com/support)

© Copyright Intersil Americas LLC 2005-2014. All Rights Reserved.  
All trademarks and registered trademarks are the property of their respective owners.

For additional products, see [www.intersil.com/en/products.html](http://www.intersil.com/en/products.html)

Intersil products are manufactured, assembled and tested utilizing ISO9001 quality systems as noted in the quality certifications found at [www.intersil.com/en/support/qualandreliability.html](http://www.intersil.com/en/support/qualandreliability.html)

*Intersil products are sold by description only. Intersil may modify the circuit design and/or specifications of products at any time without notice, provided that such modification does not, in Intersil's sole judgment, affect the form, fit or function of the product. Accordingly, the reader is cautioned to verify that datasheets are current before placing orders. Information furnished by Intersil is believed to be accurate and reliable. However, no responsibility is assumed by Intersil or its subsidiaries for its use; nor for any infringements of patents or other rights of third parties which may result from its use. No license is granted by implication or otherwise under any patent or patent rights of Intersil or its subsidiaries.*

For information regarding Intersil Corporation and its products, see [www.intersil.com](http://www.intersil.com)



# Package Outline Drawing

## L40.6x6

40 LEAD QUAD FLAT NO-LEAD PLASTIC PACKAGE

Rev 3, 10/06

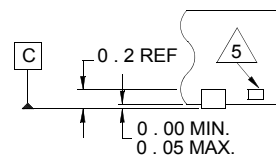
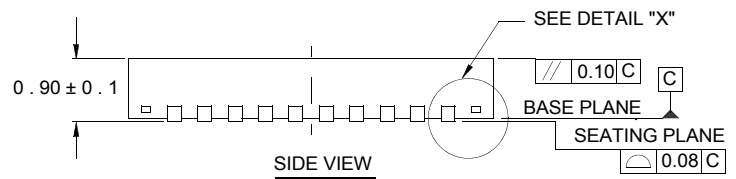
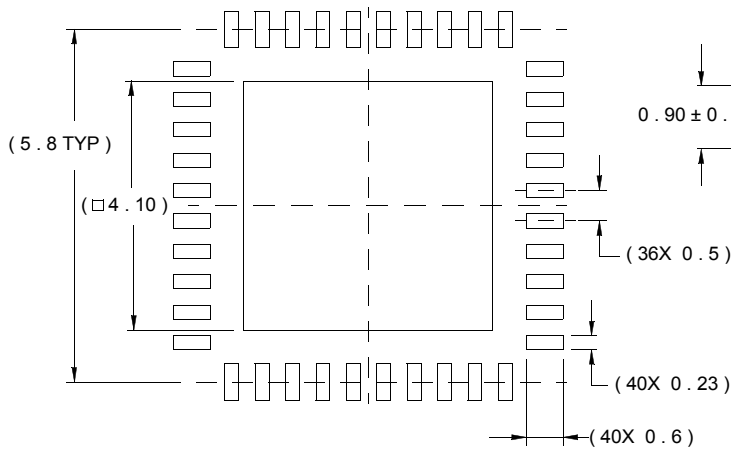
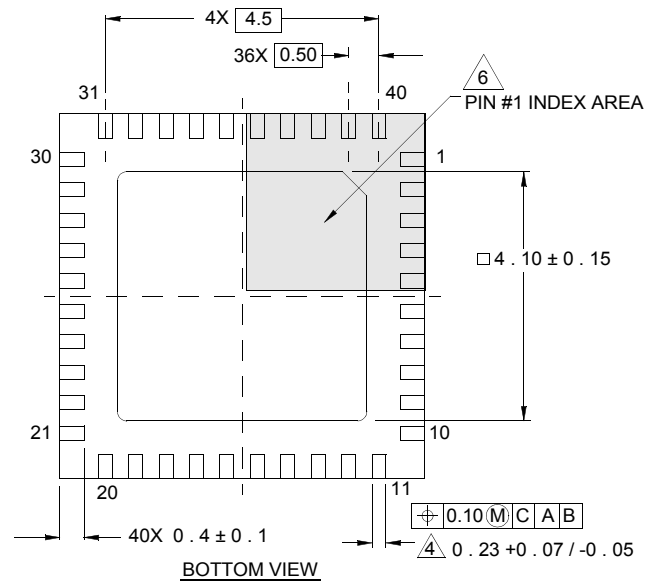
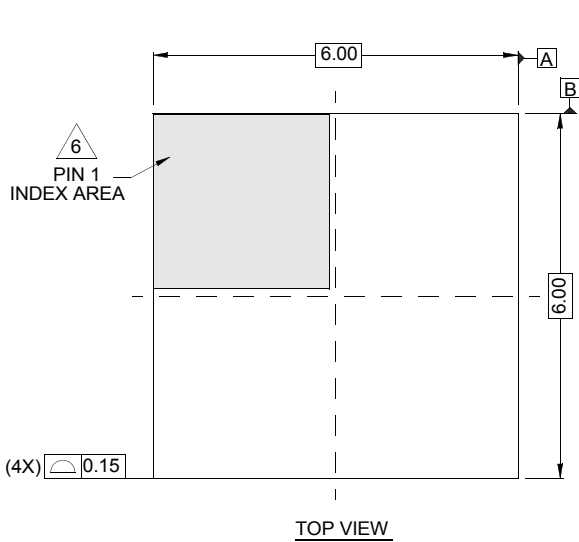

NOTES:

1. Dimensions are in millimeters.  
Dimensions in ( ) for Reference Only.
2. Dimensioning and tolerancing conform to AMSE Y14.5m-1994.
3. Unless otherwise specified, tolerance : Decimal ± 0.05
4. Dimension b applies to the metallized terminal and is measured between 0.15mm and 0.30mm from the terminal tip.
5. Tiebar shown (if present) is a non-functional feature.
6. The configuration of the pin #1 identifier is optional, but must be located within the zone indicated. The pin #1 identifier may be either a mold or mark feature.

# Package Outline Drawing

## M20.3

20 LEAD WIDE BODY SMALL OUTLINE PLASTIC PACKAGE (SOIC)

Rev 3, 2/11



TOP VIEW



SIDE VIEW



DETAIL "X"



TYPICAL RECOMMENDED LAND PATTERN

NOTES:

1. Dimensioning and tolerancing per ASME Y14.5M-1994.
2. Dimension does not include mold flash, protrusions or gate burrs. Mold flash, protrusion and gate burrs shall not exceed 0.15mm (0.006 inch) per side.
3. Dimension does not include interlead lash or protrusions. Interlead flash and protrusions shall not exceed 0.25mm (0.010 inch) per side.
4. The chamfer on the body is optional. If it is not present, a visual index feature must be located within the crosshatched area.
5. Dimension is the length of terminal for soldering to a substrate.
6. Terminal numbers are shown for reference only.
7. The lead width as measured 0.36mm (0.14 inch) or greater above the seating plane, shall not exceed a maximum value of 0.61mm (0.024 inch)
8. Controlling dimension: MILLIMETER.
9. Dimensions in ( ) for reference only.
10. JEDEC reference drawing number: MS-013-AC.

**Shrink Small Outline Plastic Packages (SSOP)**



**M20.209 (JEDEC MO-150-AE ISSUE B)**  
**20 LEAD SHRINK SMALL OUTLINE PLASTIC PACKAGE**

SYMBOL	INCHES		MILLIMETERS		NOTES
	MIN	MAX	MIN	MAX	
A	0.068	0.078	1.73	1.99	
A1	0.002	0.008'	0.05	0.21	
A2	0.066	0.070'	1.68	1.78	
B	0.010'	0.015	0.25	0.38	9
C	0.004	0.008	0.09	0.20'	
D	0.278	0.289	7.07	7.33	3
E	0.205	0.212	5.20'	5.38	4
e	0.026 BSC		0.65 BSC		
H	0.301	0.311	7.65	7.90'	
L	0.025	0.037	0.63	0.95	6
N	20		20		7
alpha	0 deg.	8 deg.	0 deg.	8 deg.	

**NOTES:**

1. Symbols are defined in the "MO Series Symbol List" in Section 2.2 of Publication Number 95.
2. Dimensioning and tolerancing per ANSI Y14.5M-1982.
3. Dimension "D" does not include mold flash, protrusions or gate burrs. Mold flash, protrusion and gate burrs shall not exceed 0.20mm (0.0078 inch) per side.
4. Dimension "E" does not include interlead flash or protrusions. Interlead flash and protrusions shall not exceed 0.20mm (0.0078 inch) per side.
5. The chamfer on the body is optional. If it is not present, a visual index feature must be located within the crosshatched area.
6. "L" is the length of terminal for soldering to a substrate.
7. "N" is the number of terminal positions.
8. Terminal numbers are shown for reference only.
9. Dimension "B" does not include dambar protrusion. Allowable dambar protrusion shall be 0.13mm (0.005 inch) total in excess of "B" dimension at maximum material condition.
10. Controlling dimension: MILLIMETER. Converted inch dimensions are not necessarily exact.

Rev. 3 11/02