



Typical Applications

The HMC734LP5(E) is ideal for:

- Point-to-Point/Multi-Point Radio
- Test Equipment & Industrial Controls
- SATCOM
- Military End-Use

Features

- Dual Output: $F_o = 8.6 - 10.2 \text{ GHz}$
 $F_o/4 = 2.15 - 2.55 \text{ GHz}$
- Pout: +18 dBm
- Phase Noise: -100 dBc/Hz @ 100 kHz Typ.
- No External Resonator Needed
- 32 Lead 5x5mm SMT Package: 25mm²

Functional Diagram

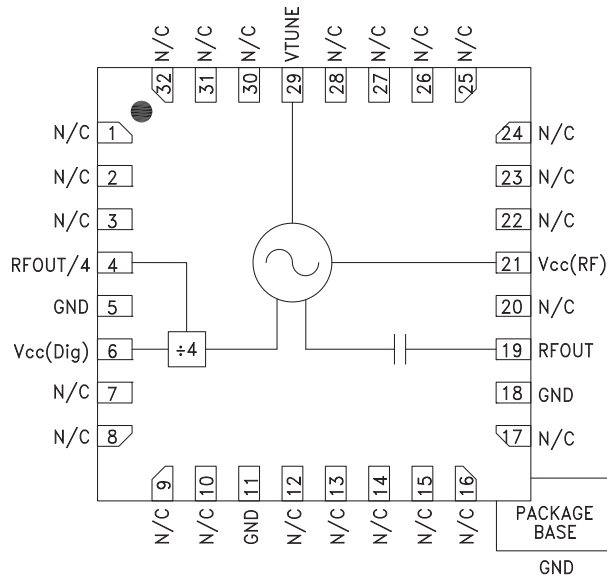

General Description

The HMC734LP5(E) is a GaAs InGaP Heterojunction Bipolar Transistor (HBT) MMIC VCO. The HMC734LP5(E) integrates a resonator, negative resistance device, varactor diode and features a divide-by-4 frequency output. The VCO's phase noise performance is excellent over temperature, shock, and process due to the oscillator's monolithic structure. Power output is +18 dBm typical from a +5V supply voltage. The prescaler function can be disabled to conserve current if not required. The voltage controlled oscillator is packaged in a leadless QFN 5x5 mm surface mount package, and requires no external matching components.

Electrical Specifications, $T_A = +25^\circ \text{C}$, $V_{cc}(\text{Dig})$, $V_{cc}(\text{Amp})$, $V_{cc}(\text{RF}) = +5\text{V}$

| Parameter | Min. | Typ. | Max. | Units | |
|-------------------------------------------------------------------|---------------------------------------------------------------|---------------------------|----------|-----------------------|----|
| Frequency Range | F_o $F_o/4$ | 8.6 - 10.2 2.15 - 2.55 | | GHz GHz | |
| Power Output | RFOUT RFOUT/4 | 15 -8 | 22 -1 | dBm dBm | |
| SSB Phase Noise @ 100 kHz Offset, $V_{tune} = +5\text{V}$ @ RFOUT | | -100 | | dBc/Hz | |
| Tune Voltage | V_{tune} | 1 | 13 | V | |
| Supply Current | $I_{cc}(\text{Dig}) + I_{cc}(\text{Amp}) + I_{cc}(\text{RF})$ | 180 | 218 | 240 | mA |
| Tune Port Leakage Current ($V_{tune} = 13\text{V}$) | | | 10 | μA | |
| Output Return Loss (RFOUT) | | 8 | | dB | |
| Harmonics/Subharmonics | 1/2 2nd 3rd | 66 15 30 | | dBc dBc | |
| Pulling (into a 2.0:1 VSWR) | | 38 | | MHz pp | |
| Pushing @ $V_{tune} = 5\text{V}$ | | 30 | | MHz/V | |
| Frequency Drift Rate | | 1.1 | | MHz/ $^\circ\text{C}$ | |

Information furnished by Analog Devices is believed to be accurate and reliable. However, no responsibility is assumed by Analog Devices for its use, nor for any infringements of patents or other rights of third parties that may result from its use. Specifications subject to change without notice. No license is granted by implication or otherwise under any patent or patent rights of Analog Devices. Trademarks and registered trademarks are the property of their respective owners.

For price, delivery, and to place orders: Analog Devices, Inc., One Technology Way, P.O. Box 9106, Norwood, MA 02062-9106
Phone: 781-329-4700 • Order online at www.analog.com
Application Support: Phone: 1-800-ANALOG-D



**MMIC VCO w/ DIVIDE-BY-4
8.6 - 10.2 GHz**

Frequency vs. Tuning Voltage, Vcc = +5V



Frequency vs. Tuning Voltage, T = 25°C



Sensitivity vs. Tuning Voltage, Vcc = +5V



Output Power vs. Tuning Voltage, Vcc = +5V



SSB Phase Noise vs. Tuning Voltage



SSB Phase Noise @ Vtune = +5V



Information furnished by Analog Devices is believed to be accurate and reliable. However, no responsibility is assumed by Analog Devices for its use, nor for any infringements of patents or other rights of third parties that may result from its use. Specifications subject to change without notice. No license is granted by implication or otherwise under any patent or patent rights of Analog Devices. Trademarks and registered trademarks are the property of their respective owners.

For price, delivery, and to place orders: Analog Devices, Inc., One Technology Way, P.O. Box 9106, Norwood, MA 02062-9106 Phone: 781-329-4700 • Order online at www.analog.com Application Support: Phone: 1-800-ANALOG-D



MMIC VCO w/ DIVIDE-BY-4 8.6 - 10.2 GHz

Divide-by-4 Frequency vs. Tuning Voltage, Vcc = +5V



Divide-by-4 Output Power vs. Tuning Voltage, Vcc = +5V

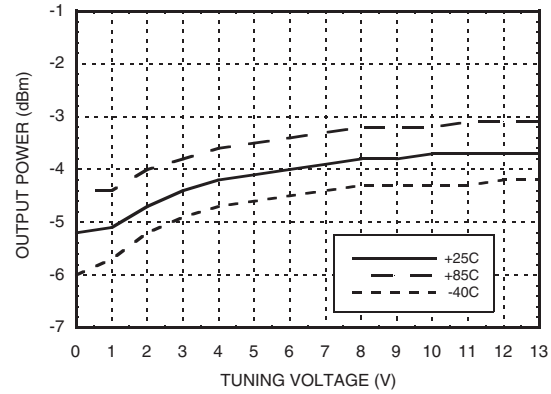

Outline Drawing

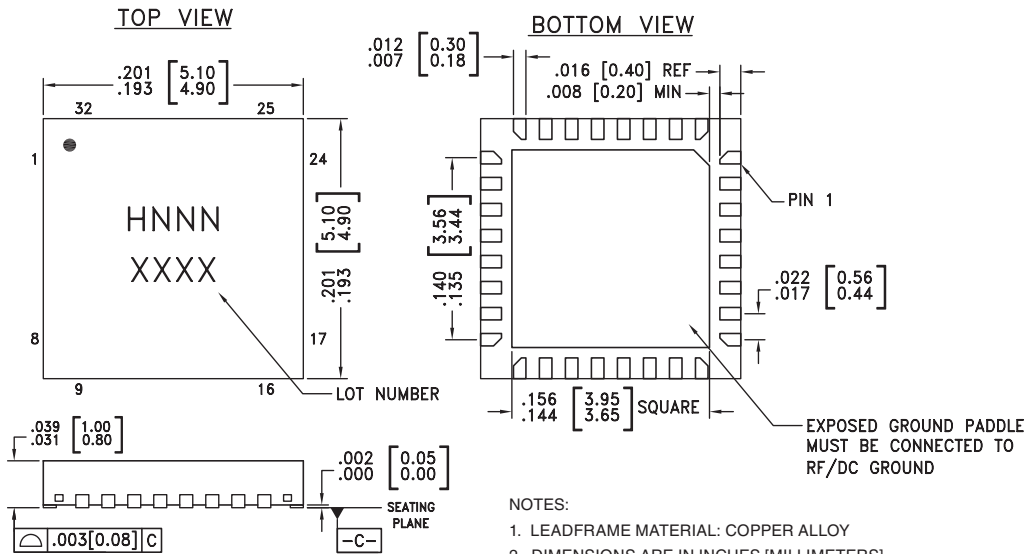

Package Information

| Part Number | Package Body Material | Lead Finish | MSL Rating | Package Marking ^[3] |
|-------------|----------------------------------------------------|---------------|---------------------|--------------------------------|
| HMC734LP5 | Low Stress Injection Molded Plastic | Sn/Pb Solder | MSL3 ^[1] | H734 XXXX |
| HMC734LP5E | RoHS-compliant Low Stress Injection Molded Plastic | 100% matte Sn | MSL3 ^[2] | H734 XXXX |

[1] Max peak reflow temperature of 235 °C

[2] Max peak reflow temperature of 260 °C

[3] 4-Digit lot number XXXX



MMIC VCO w/ DIVIDE-BY-4 8.6 - 10.2 GHz

Absolute Maximum Ratings

| | |
|--------------------------------------------------------------|----------------|
| Vcc(Dig), Vcc(Amp), Vcc(RF) | +5.5 Vdc |
| Vtune | 0 to +15V |
| Junction Temperature | 135 °C |
| Continuous Pdiss (T=85 °C) (derate 25.3 mW/C above 85 °C) | 1.3 W |
| Thermal Resistance (junction to ground paddle) | 39.5 °C/W |
| Storage Temperature | -65 to +150 °C |
| Operating Temperature | -40 to +85 °C |

Typical Supply Current vs. Vcc



| Vcc (V) | Icc (mA) |
|---------|----------|
| 4.75 | 198 |
| 5.00 | 218 |
| 5.25 | 237 |

Note: VCO will operate over full voltage range shown above.

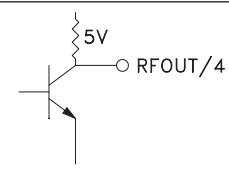
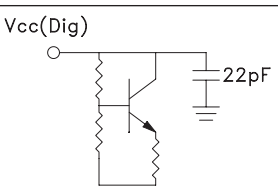
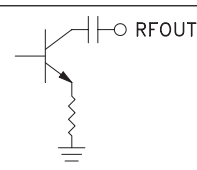
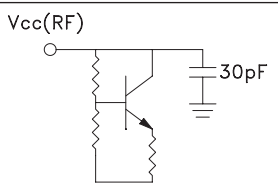
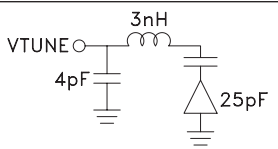

**ELECTROSTATIC SENSITIVE DEVICE
OBSERVE HANDLING PRECAUTIONS**

Pin Descriptions

| Pin Number | Function | Description | Interface Schematic |
|----------------------------------------------------|-----------|---------------------------------------------------------------------------------------------------------------------------------------------------------------------------------------|---------------------------------------------------------------------------------------|
| 1 - 3, 7 - 10, 12 - 17, 20, 22 - 28, 30 - 32 | N/C | No Connection. These pins may be connected to RF/DC ground. Performance will not be affected. | |
| 4 | RFOUT/4 | Divide-by-4 output. DC block required. |  |
| 6 | Vcc (Dig) | Supply voltage for prescaler. If prescaler is not required, this pin may be left open to conserve approximately 100 mA of current. |  |
| 19 | RFOUT | RF output (AC coupled). |  |
| 21 | Vcc (RF) | Supply Voltage, +5V |  |
| 29 | VTUNE | Control voltage and modulation input. Modulation bandwidth dependent on drive source impedance. See "Determining the FM Bandwidth of a Wideband Varactor Tuned VCO" application note. |  |
| 5, 11, 18, Paddle | GND | Package bottom has an exposed metal paddle that must be connected to RF/DC ground. |  |



**MMIC VCO w/ DIVIDE-BY-4
8.6 - 10.2 GHz**

Application Circuit

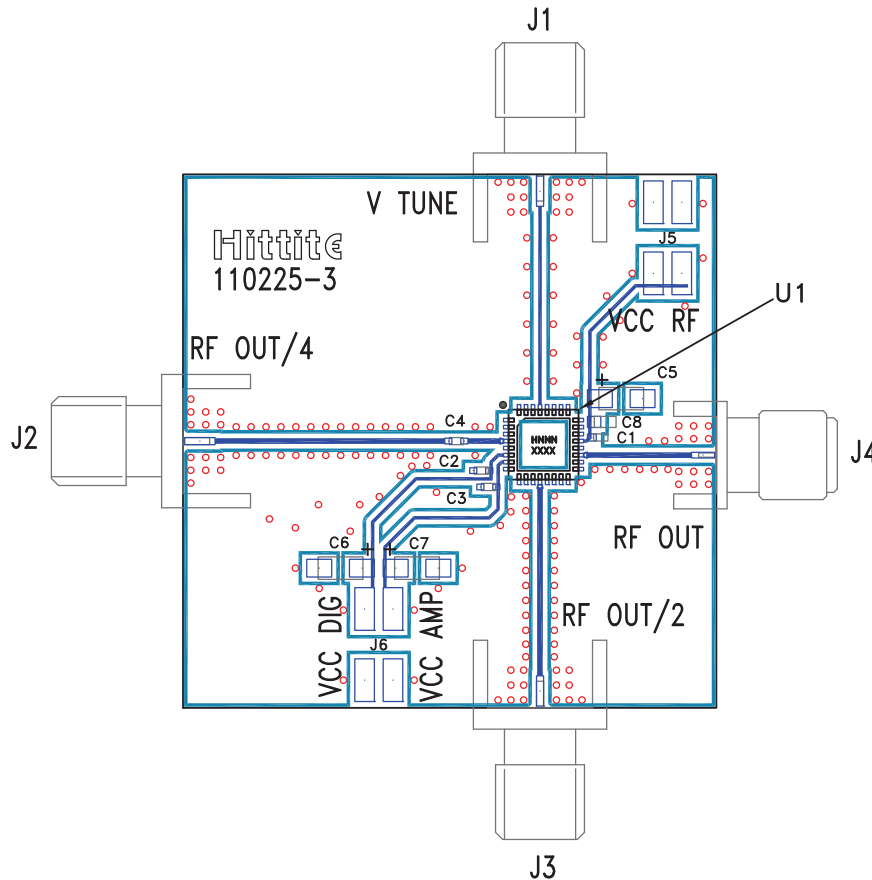

Evaluation PCB

List of Materials for Evaluation PCB 110227 [1]

| Item | Description |
|---------|--------------------------------|
| J1 - J4 | PCB Mount SMA RF Connector |
| J5 - J6 | 2 mm DC Header |
| C1 - C3 | 100 pF Capacitor, 0402 Pkg. |
| C4 | 1,000 pF Capacitor, 0402 Pkg. |
| C5 - C7 | 2.2 μ F Tantalum Capacitor |
| U1 | HMC734LP5(E) VCO |
| PCB [2] | 110225 Eval Board |

[1] Reference this number when ordering complete evaluation PCB

[2] Circuit Board Material: Rogers 4350 or Arlon 25FR

The circuit board used in the application should use RF circuit design techniques. Signal lines should have 50 Ohm impedance while the package ground leads and backside ground paddle should be connected directly to the ground plane similar to that shown. A sufficient number of via holes should be used to connect the top and bottom ground planes. The evaluation circuit board shown is available from Hittite upon request.