

TRB SERIES



*8-pin models UL listed when used in combination with P1011-6 socket only.



8-PIN



11-PIN

Description

The TRB Series combines an isolated, 10A electromechanical relay output with analog timing circuitry. False trigger of the TRB by a transient is unlikely because of the complete isolation of the circuit from the line prior to initiation. The initiate contact is common to one side of the line and may be utilized to operate other loads. Installation is easy due to the TRB's industry standard 8- or 11-pin plug-in base wiring.

Operation (Delay-on-Break)

Input voltage must be applied before and during timing. Upon closure of the initiate switch, the output relay energizes. The time delay begins when the initiate switch is opened (trailing edge triggered). The output remains energized during timing. At the end of the time delay, the output de-energizes. The output will energize if the initiate switch is closed when input voltage is applied.

Reset: Reclosing the initiate switch during timing resets the time delay. Loss of input voltage resets the time delay and output.

Wiring Diagram

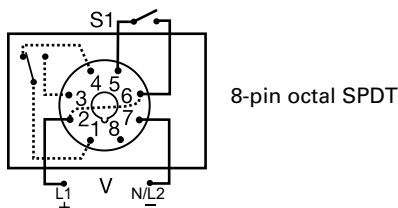

8-pin octal SPDT

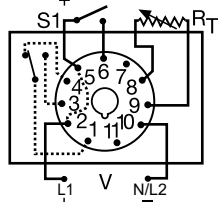

11-pin SPDT

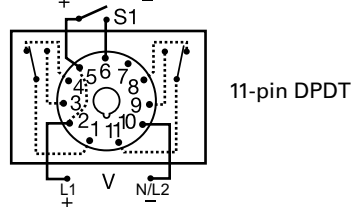



11-pin DPDT

V = Voltage
S1 = Initiate Switch
Relay contacts are isolated.
R_T is used when external adjustment is ordered.

Features & Benefits

FEATURES	BENEFITS
Complete isolation of circuit from line	No false trip due to transients
Industry standard 8 or 11-pin connection	Provides easy installation and field replacement
Isolated, 10A, SPDT or DPDT output contacts	Allows control of loads for AC or DC voltages
Analog circuitry	Repeat accuracy + /- 2%

Accessories

- 
P1004-XX, P1004-XX-X Versa-Pot
Panel mountable, industrial potentiometer recommended for remote time delay adjustment.
- 
P0700-7 Versa-Knob
Designed for 0.25 in (6.35 mm) shaft of Versa-Pot. Semi-gloss industrial black finish.
- 
BZ1 Front Panel Mount Kit
Provides an easy method of through-the-panel mounting of 8- or 11-pin plug-in timers, flashers, and other controls.

Ordering Information

MODEL	INPUT VOLTAGE	ADJUSTMENT	OUTPUT FORM	TIME TOLERANCE	TIME DELAY
TRB120A2Y30	120VAC	Onboard	Octal, SPDT (AC only)	+ /- 10%	1 - 30s
TRB120A3X600	120VAC	Lock shaft	Octal, SPDT (AC only)	+ /- 20%	7 - 600s
TRB120A4Y120	120VAC	Onboard	11-pin, DPDT	+ /- 10%	2 - 120s
TRB24D10Y10	24VDC/28VDC	Fixed	11-pin, DPDT	+ /- 10%	10s

If you don't find the part you need, call us for a custom product 800-843-8848

TRB SERIES

Accessories



NDS-8 Octal 8-pin Socket
8-pin 35mm DIN rail or surface mount. Surface mounted with two #6 screws or snaps onto a 35 mm DIN rail. Uses PSC8 hold-down clips.



NDS-11 11-pin Socket
11-pin 35mm DIN rail or surface mount. Surface mounted with two #6 screws or snaps onto a 35 mm DIN rail. Uses PSC11 hold-down clips.



P1011-6 Octal Socket for UL listing*
8-pin surface mount socket with binder head screw terminals. Rated 10A @ 600VAC.

Selection Guides

External R _T P/N Selection Table	
Value	Part Number
1M ohm	P1004-16
1.5M ohm	P1004-15
2M ohm	P1004-14
3M ohm	P1004-12
5M ohm	P1004-13
1M ohm	P1004-16-X
1.5M ohm	P1004-15-X
2M ohm	P1004-14-X
3M ohm	P1004-12-X
5M ohm	P1004-13-X

R _T Selection Chart	
Time Delay*	
Range	R _T
Seconds	Megohm
0.05...1	1.0
0.05...2	2.0
0.05...3	3.0
0.1...5	5.0
0.1...10	3.0
1...30	1.5
1...60	3.0
2...120	2.0
2...180	3.0
7...240	1.5
7...300	2.0
7...360	2.0
7...420	3.0
7...480	3.0
7...600	5.0

* When selecting an external R_T add at least 15...30% for tolerance of unit and the R_T.

Function Diagram

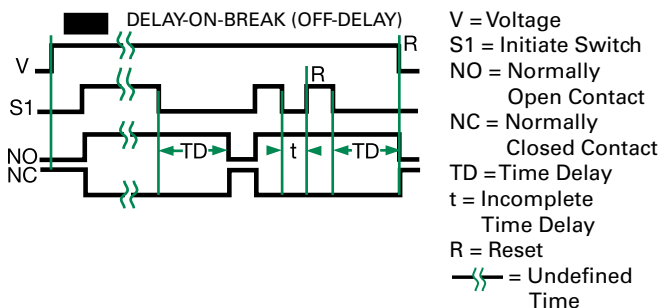

Specifications

Time Delay

Type Analog circuitry
Range 50ms - 10m in 15 adjustable ranges or fixed
Repeat Accuracy ±2% or 20ms, whichever is greater

Fixed Time Tolerance & Setting Accuracy ±5, 10, or 20%

Initiate Time ≤ 70ms

Reset Time ≤ 75ms

Recycle Time ≤ 250ms

Time Delay vs Temp. & Voltage ≤ ±10%

Input Voltage

24/28 or 110VDC; 24, 120, or 230VAC (DC voltages on DPDT output models only)

Tolerance

24VDC/AC -15% - 20%

10 to 230VAC/DC -20% - 10%

AC Line Frequency 50/60 Hz

Power Consumption ≤ 3.25W

Output

Type Electromechanical relay
Form Isolated SPDT or DPDT
Rating 10A resistive @ 120/240VAC & 28VDC; 1/3 hp @ 120/240VAC
Life Mechanical - 1 x 10⁷; Electrical - 1 x 10⁶

Protection

Insulation Resistance ≥ 100 MΩ
Isolation Voltage ≥ 1500V RMS between input to output
Polarity DC units are reverse polarity protected

Mechanical

Mounting Plug-in socket
Dimensions **H** 91.6 mm (3.62"); **W** 60.7 mm (2.39"); **D** 45.2 mm (1.78")

Termination

Octal 8-pin plug-in or 11-pin plug-in

Environmental

Operating/Storage

Temperature -20° to 65°C / -30° to 85°C
Weight ≈ 6 oz (170 g)