

FEATURES

Two channels in a small 4 mm × 4 mm LFCSP

Custom LFCSP package with hidden paddle

Permits routing and vias underneath package

Allows full bias current performance

Low input currents

10 pA maximum input bias current (B grade)

0.6 pA maximum input offset current (B grade)

High CMRR

100 dB CMRR (minimum), $G = 10$ (B grade)

90 dB CMRR (minimum) to 10 kHz, $G = 10$ (B grade)

Excellent ac specifications and low power

1.5 MHz bandwidth ($G = 1$)

14 nV/√Hz input noise (1 kHz)

Slew rate: 2 V/μs

750 μA quiescent current per amplifier

Versatility

Rail-to-rail output

Input voltage range to below negative supply rail

4 kV ESD protection

4.5 V to 36 V single supply

±2.25 V to ±18 V dual supply

Gain set with single resistor ($G = 1$ to 1000)

APPLICATIONS

Medical instrumentation

Precision data acquisition

Transducer interfaces

Differential drives for high resolution input ADCs

Remote sensors

GENERAL DESCRIPTION

The [AD8224](#) is the first single-supply, JFET input instrumentation amplifier available in the space-saving 16-lead, 4 mm × 4 mm LFCSP. It requires the same board area as a typical single instrumentation amplifier yet doubles the channel density and offers a lower cost per channel without compromising performance.

Designed to meet the needs of high performance, portable instrumentation, the [AD8224](#) has a minimum common-mode rejection ratio (CMRR) of 86 dB at dc and a minimum CMRR of 80 dB at 10 kHz for $G = 1$. Maximum input bias current is 10 pA and typically remains below 300 pA over the entire industrial temperature range. Despite the JFET inputs, the [AD8224](#) typically has a noise corner of only 10 Hz.

With the proliferation of mixed-signal processing, the number of power supplies required in each system has grown. Designed

Rev. D

[Document Feedback](#)

Information furnished by Analog Devices is believed to be accurate and reliable. However, no responsibility is assumed by Analog Devices for its use, nor for any infringements of patents or other rights of third parties that may result from its use. Specifications subject to change without notice. No license is granted by implication or otherwise under any patent or patent rights of Analog Devices. Trademarks and registered trademarks are the property of their respective owners.

FUNCTIONAL BLOCK DIAGRAM



Figure 1.

Table 1. In Amps and Difference Amplifiers by Category

| High Perform | Low Cost | High Voltage | Mil Grade | Low Power | Digital Gain |
|-------------------------------------|-------------------------------------|-----------------------|-----------------------|------------------------------------|-------------------------------------|
| AD8220 ¹ | AD8553 ¹ | AD628 | AD620 | AD627 ¹ | AD8231 ¹ |
| AD8221 | AD623 ¹ | AD629 | AD621 | | AD8250 |
| AD8222 | | | AD524 | | AD8251 |
| | | | AD526 | | AD8555 ¹ |
| | | | AD624 | | AD8556 ¹ |
| | | | | | AD8557 ¹ |

¹ Rail-to-rail output.

to alleviate this problem, the [AD8224](#) can operate on a ±18 V dual supply, as well as on a single +5 V supply. The device's rail-to-rail output stage maximizes dynamic range on the low voltage supplies common in portable applications. Its ability to run on a single 5 V supply eliminates the need for higher voltage, dual supplies. The [AD8224](#) draws 750 μA of quiescent current per amplifier, making it ideal for battery powered devices.

In addition, the [AD8224](#) can be configured as a single-channel, differential output, instrumentation amplifier. Differential outputs provide high noise immunity, which can be useful when the output signal must travel through a noisy environment, such as with remote sensors. The configuration can also be used to drive differential input ADCs. For a single-channel version, use the [AD8220](#).

TABLE OF CONTENTS

| | | | |
|--|----|---------------------------------------|----|
| Features | 1 | Layout | 22 |
| Applications..... | 1 | Solder Wash..... | 23 |
| Functional Block Diagram | 1 | Input Bias Current Return Path | 23 |
| General Description | 1 | Input Protection | 23 |
| Revision History | 2 | RF Interference | 24 |
| Specifications..... | 3 | Common-Mode Input Voltage Range | 24 |
| Absolute Maximum Ratings..... | 9 | Applications Information | 25 |
| Thermal Resistance | 9 | Driving an ADC | 25 |
| ESD Caution..... | 9 | Differential Output | 25 |
| Pin Configurations and Function Descriptions | 10 | Driving a Differential Input ADC..... | 26 |
| Typical Performance Characteristics | 12 | Driving Cabling..... | 26 |
| Theory of Operation | 21 | Outline Dimensions | 27 |
| Gain Selection | 21 | Ordering Guide | 28 |
| Reference Terminal | 22 | | |

REVISION HISTORY

4/16—Rev. C to Rev. D

| | |
|--|------------|
| Changed CP-16-13 to CP-16-26 | Throughout |
| Changes to Figure 3..... | 10 |
| Added Figure 4 and Table 12; Renumbered Sequentially | 11 |
| Updated Outline Dimensions | 27 |
| Changes to Ordering Guide | 28 |

12/13—Rev. B to Rev. C

| | |
|---|----|
| Changes to Input Current Parameter and Power Supply Parameter, Table 2..... | 3 |
| Changes to Table 3 and Table 4..... | 5 |
| Changes to Input Current Parameter and Power Supply Parameter, Table 5..... | 6 |
| Changes to Table 9..... | 9 |
| Changes to Figure 53..... | 19 |
| Change to Theory of Operation Section | 20 |
| Change to Exposed Paddle Package Section..... | 21 |
| Change to Input Protection Section..... | 22 |
| Updated Outline Dimensions (Dimensions Not Changed, Minimums and Maximums Added) | 26 |

5/10—Rev. A to Rev. B

| | |
|---------------------------------------|----|
| Changes to Features Section..... | 1 |
| Added Table 10 | 9 |
| Changes to Figure 3 and Table 11..... | 10 |

Added Hidden Paddle Package Section and Exposed Paddle

| | |
|-------------------------------------|----|
| Package Section and Figure 58 | 21 |
| Updated Outline Dimensions | 26 |
| Changes to Ordering Guide | 27 |

4/07—Rev. 0 to Rev. A

| | |
|---|----|
| Changes to Features, General Description, and Figure 1 | 1 |
| Changes to Table 2..... | 3 |
| Changes to Table 3 and Table 4..... | 5 |
| Changes to Table 5..... | 6 |
| Changes to Table 6 and Table 7..... | 8 |
| Changes to Figure 2..... | 9 |
| Changes to Figure 3..... | 10 |
| Inserted Figure 4, Figure 5, and Figure 6; Renumbered Sequentially | 11 |
| Changes to Figure 7..... | 11 |
| Changes to Figure 20 and Figure 21 | 13 |
| Changes to Figure 28..... | 15 |
| Changes to Theory of Operation and Figure 55 | 20 |
| Changes to Ordering Guide | 26 |

1/07—Revision 0: Initial Version

SPECIFICATIONS

$V_S = +15\text{ V}$, $V_S = -15\text{ V}$, $V_{REF} = 0\text{ V}$, $T_A = 25^\circ\text{C}$, $G = 1$, $R_L = 2\text{ k}\Omega$ ¹, unless otherwise noted. Table 2 displays the specifications for an individual instrumentation amplifier configured for a single-ended output or dual instrumentation amplifiers configured for differential outputs as shown in Figure 64.

Table 2. Individual Amplifier in Single-Ended Configuration or Dual Amplifiers in Differential Output Configuration², $V_S = \pm 15\text{ V}$

| Parameter | Test Conditions/ Comments | A Grade | | | B Grade | | | Unit |
|--|---|---------|-------------------|--------|-------------------|-----|--------|------------------------------|
| | | Min | Typ | Max | Min | Typ | Max | |
| COMMON-MODE REJECTION RATIO (CMRR) | | | | | | | | |
| CMRR DC to 60 Hz with 1 k Ω Source Imbalance | $V_{CM} = \pm 10\text{ V}$ | | | | | | | |
| G = 1 | | 78 | | | 86 | | | dB |
| G = 10 | | 94 | | | 100 | | | dB |
| G = 100 | | 94 | | | 100 | | | dB |
| CMRR at 10 kHz | $V_{CM} = \pm 10\text{ V}$ | | | | | | | |
| G = 1 | | 74 | | | 80 | | | dB |
| G = 10 | | 84 | | | 90 | | | dB |
| G = 100 | | 84 | | | 90 | | | dB |
| G = 1000 | 84 | | | 90 | | | dB | |
| NOISE | | | | | | | | |
| | RTI noise = $\sqrt{(e_{ni}^2 + (e_{no}/G)^2)}$ | | | | | | | |
| Voltage Noise, 1 kHz | | | | | | | | |
| Input Voltage Noise, e_{ni} | $V_{IN+}, V_{IN-} = 0\text{ V}$ | | 14 | | 14 | 17 | | nV/ $\sqrt{\text{Hz}}$ |
| Output Voltage Noise, e_{no} | $V_{IN+}, V_{IN-} = 0\text{ V}$ | | 90 | | 90 | 100 | | nV/ $\sqrt{\text{Hz}}$ |
| RTI, 0.1 Hz to 10 Hz | | | | | | | | |
| G = 1 | | | 5 | | 5 | | | $\mu\text{V p-p}$ |
| G = 1000 | | | 0.8 | | 0.8 | | | $\mu\text{V p-p}$ |
| Current Noise | $f = 1\text{ kHz}$ | | 1 | | 1 | | | fA/ $\sqrt{\text{Hz}}$ |
| VOLTAGE OFFSET | | | | | | | | |
| Input Offset, V_{OSI} | RTI $V_{OS} =$ $(V_{OSI}) + (V_{OSO}/G)$ | | | 300 | | 175 | | μV |
| Average TC | $T = -40^\circ\text{C to } +85^\circ\text{C}$ | | | 10 | | 5 | | $\mu\text{V}/^\circ\text{C}$ |
| Output Offset, V_{OSO} | | | | 1200 | | 800 | | μV |
| Average TC | $T = -40^\circ\text{C to } +85^\circ\text{C}$ | | | 10 | | 5 | | $\mu\text{V}/^\circ\text{C}$ |
| Offset RTI vs. Supply (PSR) | $V_S = \pm 5\text{ V to } \pm 15\text{ V}$ | | | | | | | |
| G = 1 | | 86 | | | 86 | | | dB |
| G = 10 | | 96 | | | 100 | | | dB |
| G = 100 | | 96 | | | 100 | | | dB |
| G = 1000 | | 96 | | | 100 | | | dB |
| INPUT CURRENT | | | | | | | | |
| Input Bias Current | | | | 25 | | 10 | | pA |
| Over Temperature ³ | $T = -40^\circ\text{C to } +85^\circ\text{C}$ | | 300 | | 300 | | | pA |
| Input Offset Current | | | | 2 | | 0.6 | | pA |
| Over Temperature ³ | $T = -40^\circ\text{C to } +85^\circ\text{C}$ | | 5 | | 5 | | | pA |
| REFERENCE INPUT | | | | | | | | |
| R_{IN} | | | 40 | | 40 | | | k Ω |
| I_{IN} | $V_{IN+}, V_{IN-} = 0\text{ V}$ | | | 70 | | 70 | | μA |
| Voltage Range | | $-V_S$ | | $+V_S$ | $-V_S$ | | $+V_S$ | V |
| Gain to Output | | | $1 \pm$ 0.0001 | | $1 \pm$ 0.0001 | | | V/V |

| Parameter | Test Conditions/ Comments | A Grade | | | B Grade | | | Unit |
|--|--|--------------|---------------------|--------------|--------------|---------------------|--------------|--------|
| | | Min | Typ | Max | Min | Typ | Max | |
| GAIN | | | | | | | | |
| Gain Range | $G = 1 + (49.4 \text{ k}\Omega/R_G)$ | 1 | | 1000 | 1 | | 1000 | V/V |
| Gain Error | $V_{OUT} = \pm 10 \text{ V}$ | | | | | | | |
| G = 1 | | | | 0.06 | | | 0.04 | % |
| G = 10 | | | | 0.3 | | | 0.2 | % |
| G = 100 | | | | 0.3 | | | 0.2 | % |
| G = 1000 | | | | 0.3 | | | 0.2 | % |
| Gain Nonlinearity | | | | | | | | |
| G = 1 | $V_{OUT} = -10 \text{ V to } +10 \text{ V}$ | | | | | | | |
| G = 10 | $R_L = 10 \text{ k}\Omega$ | | 8 | 15 | | 8 | 15 | ppm |
| G = 100 | $R_L = 10 \text{ k}\Omega$ | | 5 | 10 | | 5 | 10 | ppm |
| G = 1000 | $R_L = 10 \text{ k}\Omega$ | | 15 | 25 | | 15 | 25 | ppm |
| G = 1 | $R_L = 2 \text{ k}\Omega$ | | 15 | 20 | | 15 | 20 | ppm |
| G = 10 | $R_L = 2 \text{ k}\Omega$ | | 12 | 20 | | 12 | 20 | ppm |
| G = 100 | $R_L = 2 \text{ k}\Omega$ | | 35 | 50 | | 35 | 50 | ppm |
| G = 1000 | $R_L = 2 \text{ k}\Omega$ | | 180 | 250 | | 180 | 250 | ppm |
| Gain vs. Temperature | | | | | | | | |
| G = 1 | | | 3 | 10 | | 2 | 5 | ppm/°C |
| G > 10 | | | | -50 | | | -50 | ppm/°C |
| INPUT | | | | | | | | |
| Impedance (Pin to Ground) ⁴ | | | 10 ⁴ 5 | | | 10 ⁴ 5 | | GΩ pF |
| Input Operating Voltage Range ⁵ | $V_S = \pm 2.25 \text{ V to } \pm 18 \text{ V}$ for dual supplies | $-V_S - 0.1$ | | $+V_S - 2$ | $-V_S - 0.1$ | | $+V_S - 2$ | V |
| Over Temperature | $T = -40^\circ\text{C to } +85^\circ\text{C}$ | $-V_S - 0.1$ | | $+V_S - 2.1$ | $-V_S - 0.1$ | | $+V_S - 2.1$ | V |
| OUTPUT | | | | | | | | |
| Output Swing | $R_L = 2 \text{ k}\Omega$ | -14.25 | | +14.25 | -14.25 | | +14.25 | V |
| Over Temperature | $T = -40^\circ\text{C to } +85^\circ\text{C}$ | -14.3 | | +14.1 | -14.3 | | +14.1 | V |
| Output Swing | $R_L = 10 \text{ k}\Omega$ | -14.7 | | +14.7 | -14.7 | | +14.7 | V |
| Over Temperature | $T = -40^\circ\text{C to } +85^\circ\text{C}$ | -14.6 | | +14.6 | -14.6 | | +14.6 | V |
| Short-Circuit Current | | | 15 | | | 15 | | mA |
| POWER SUPPLY | | | | | | | | |
| Operating Range | | $\pm 2.25^6$ | | ± 18 | $\pm 2.25^6$ | | ± 18 | V |
| Quiescent Current (Per Amplifier) | | | 750 | 800 | | 750 | 800 | μA |
| Over Temperature | $T = -40^\circ\text{C to } +85^\circ\text{C}$ | | 850 | 900 | | 850 | 900 | μA |
| TEMPERATURE RANGE | | | | | | | | |
| For Specified Performance | | -40 | | +85 | -40 | | +85 | °C |
| Operational ⁷ | | -40 | | +125 | -40 | | +125 | °C |

¹ When the output sinks more than 4 mA, use a 47 pF capacitor in parallel with the load to prevent ringing. Otherwise, use a larger load, such as 10 kΩ.

² Refers to the differential configuration shown in Figure 64.

³ Refer to Figure 15 and Figure 16 for the relationship between input current and temperature.

⁴ Differential and common-mode input impedance can be calculated from the pin impedance: $Z_{DIFF} = 2(Z_{PIN})$; $Z_{CM} = Z_{PIN}/2$.

⁵ The AD8224 can operate up to a diode drop below the negative supply; however, the bias current increases sharply. The input voltage range reflects the maximum allowable voltage where the input bias current is within the specification.

⁶ At this supply voltage, ensure that the input common-mode voltage is within the input voltage range specification.

⁷ The AD8224 is characterized from $-40^\circ\text{C to } +125^\circ\text{C}$. See the Typical Performance Characteristics section for expected operation in this temperature range.

$V_{S+} = +15\text{ V}$, $V_{S-} = -15\text{ V}$, $V_{REF} = 0\text{ V}$, $T_A = 25^\circ\text{C}$, $G = 1$, $R_L = 2\text{ k}\Omega$ ¹, unless otherwise noted. Table 3 displays the specifications for the dynamic performance of each individual instrumentation amplifier.

Table 3. Dynamic Performance of Each Individual Amplifier—Single-Ended Output Configuration, $V_S = \pm 15\text{ V}$

| Parameter | Test Conditions/ Comments | A Grade | | | B Grade | | | Unit |
|------------------------------|-------------------------------------|---------|------|-----|---------|-----|-----|------------------|
| | | Min | Typ | Max | Min | Typ | Max | |
| DYNAMIC RESPONSE | | | | | | | | |
| Small Signal Bandwidth –3 dB | | | | | | | | |
| G = 1 | | | 1500 | | 1500 | | | kHz |
| G = 10 | | | 800 | | 800 | | | kHz |
| G = 100 | | | 120 | | 120 | | | kHz |
| G = 1000 | | | 14 | | 14 | | | kHz |
| Settling Time 0.01% | $\Delta V_O = \pm 10\text{ V}$ step | | | | | | | |
| G = 1 | | | 5 | | 5 | | | μs |
| G = 10 | | | 4.3 | | 4.3 | | | μs |
| G = 100 | | | 8.1 | | 8.1 | | | μs |
| G = 1000 | | | 58 | | 58 | | | μs |
| Settling Time 0.001% | $\Delta V_O = \pm 10\text{ V}$ step | | | | | | | |
| G = 1 | | | 6 | | 6 | | | μs |
| G = 10 | | | 4.6 | | 4.6 | | | μs |
| G = 100 | | | 9.6 | | 9.6 | | | μs |
| G = 1000 | | | 74 | | 74 | | | μs |
| Slew Rate | | | | | | | | |
| G = 1 to 100 | | 2 | | | 2 | | | V/ μs |

¹ When the output sinks more than 4 mA, use a 47 pF capacitor in parallel with the load to prevent ringing. Otherwise, use a larger load, such as 10 k Ω .

$V_{S+} = +15\text{ V}$, $V_{S-} = -15\text{ V}$, $V_{REF} = 0\text{ V}$, $T_A = 25^\circ\text{C}$, $G = 1$, $R_L = 2\text{ k}\Omega$ ¹, unless otherwise noted. Table 4 displays the specifications for the dynamic performance of both amplifiers when used in the differential output configuration shown in Figure 64.

Table 4. Dynamic Performance of Both Amplifiers—Differential Output Configuration², $V_S = \pm 15\text{ V}$

| Parameter | Test Conditions/ Comments | A Grade | | | B Grade | | | Unit |
|------------------------------|-------------------------------------|---------|------|-----|---------|-----|-----|------------------|
| | | Min | Typ | Max | Min | Typ | Max | |
| DYNAMIC RESPONSE | | | | | | | | |
| Small Signal Bandwidth –3 dB | | | | | | | | |
| G = 1 | | | 1500 | | 1500 | | | kHz |
| G = 10 | | | 800 | | 800 | | | kHz |
| G = 100 | | | 120 | | 120 | | | kHz |
| G = 1000 | | | 14 | | 14 | | | kHz |
| Settling Time 0.01% | $\Delta V_O = \pm 10\text{ V}$ step | | | | | | | |
| G = 1 | | | 5 | | 5 | | | μs |
| G = 10 | | | 4.3 | | 4.3 | | | μs |
| G = 100 | | | 8.1 | | 8.1 | | | μs |
| G = 1000 | | | 58 | | 58 | | | μs |
| Settling Time 0.001% | $\Delta V_O = \pm 10\text{ V}$ step | | | | | | | |
| G = 1 | | | 6 | | 6 | | | μs |
| G = 10 | | | 4.6 | | 4.6 | | | μs |
| G = 100 | | | 9.6 | | 9.6 | | | μs |
| G = 1000 | | | 74 | | 74 | | | μs |
| Slew Rate | | | | | | | | |
| G = 1 to 100 | | 2 | | | 2 | | | V/ μs |

¹ When the output sinks more than 4 mA, use a 47 pF capacitor in parallel with the load to prevent ringing. Otherwise, use a larger load, such as 10 k Ω .

² Refers to the differential configuration shown in Figure 64.

$V_S + = 5\text{ V}$, $V_S - = 0\text{ V}$, $V_{REF} = 2.5\text{ V}$, $T_A = 25^\circ\text{C}$, $G = 1$, $R_L = 2\text{ k}\Omega^1$, unless otherwise noted. Table 5 displays the specifications for an individual instrumentation amplifier configured for a single-ended output or dual instrumentation amplifiers configured for differential outputs as shown in Figure 64.

Table 5. Individual Amplifier in Single-Ended Configuration or Dual Amplifiers in Differential Output Configuration², $V_S = +5\text{ V}$

| Parameter | Test Conditions/ Comments | A Grade | | | B Grade | | | Unit |
|--|--|---------|-------------------|--------|---------|-------------------|--------|------------------------------|
| | | Min | Typ | Max | Min | Typ | Max | |
| COMMON-MODE REJECTION RATIO (CMRR) | | | | | | | | |
| CMRR DC to 60 Hz with 1 k Ω Source Imbalance | $V_{CM} = 0$ to 2.5 V | | | | | | | |
| G = 1 | | 78 | | | 86 | | | dB |
| G = 10 | | 94 | | | 100 | | | dB |
| G = 100 | | 94 | | | 100 | | | dB |
| G = 1000 | | 94 | | | 100 | | | dB |
| CMRR at 10 kHz | | | | | | | | |
| G = 1 | | 74 | | | 80 | | | dB |
| G = 10 | | 84 | | | 90 | | | dB |
| G = 100 | | 84 | | | 90 | | | dB |
| G = 1000 | | 84 | | | 90 | | | dB |
| NOISE | | | | | | | | |
| Voltage Noise, 1 kHz | RTI noise = $\sqrt{(e_{ni}^2 + (e_{no}/G)^2)}$ $V_S = \pm 2.5\text{ V}$ | | | | | | | |
| Input Voltage Noise, e_{ni} | $V_{IN+}, V_{IN-} = 0\text{ V}, V_{REF} = 0\text{ V}$ | | 14 | | 14 | 17 | | nV/ $\sqrt{\text{Hz}}$ |
| Output Voltage Noise, e_{no} | $V_{IN+}, V_{IN-} = 0\text{ V}, V_{REF} = 0\text{ V}$ | | 90 | | 90 | 100 | | nV/ $\sqrt{\text{Hz}}$ |
| RTI, 0.1 Hz to 10 Hz | | | | | | | | |
| G = 1 | | | 5 | | 5 | | | $\mu\text{V p-p}$ |
| G = 1000 | | | 0.8 | | 0.8 | | | $\mu\text{V p-p}$ |
| Current Noise | $f = 1\text{ kHz}$ | | 1 | | 1 | | | fA/ $\sqrt{\text{Hz}}$ |
| VOLTAGE OFFSET | | | | | | | | |
| Input Offset, V_{OSI} | RTI $V_{OS} = (V_{OSI}) + (V_{OSO}/G)$ | | | 300 | | 250 | | μV |
| Average TC | $T = -40^\circ\text{C}$ to $+85^\circ\text{C}$ | | | 10 | | 5 | | $\mu\text{V}/^\circ\text{C}$ |
| Output Offset, V_{OSO} | | | | 1200 | | 800 | | μV |
| Average TC | $T = -40^\circ\text{C}$ to $+85^\circ\text{C}$ | | | 10 | | 5 | | $\mu\text{V}/^\circ\text{C}$ |
| Offset RTI vs. Supply (PSR) | | | | | | | | |
| G = 1 | | 86 | | | 86 | | | dB |
| G = 10 | | 96 | | | 100 | | | dB |
| G = 100 | | 96 | | | 100 | | | dB |
| G = 1000 | | 96 | | | 100 | | | dB |
| INPUT CURRENT | | | | | | | | |
| Input Bias Current | | | | 25 | | 10 | | pA |
| Over Temperature ³ | $T = -40^\circ\text{C}$ to $+85^\circ\text{C}$ | | 300 | | 300 | | | pA |
| Input Offset Current | | | | 2 | | 0.6 | | pA |
| Over Temperature ³ | $T = -40^\circ\text{C}$ to $+85^\circ\text{C}$ | | 5 | | 5 | | | pA |
| REFERENCE INPUT | | | | | | | | |
| R_{IN} | | | 40 | | 40 | | | k Ω |
| I_{IN} | $V_{IN+}, V_{IN-} = 0\text{ V}$ | | | 70 | | 70 | | μA |
| Voltage Range | | $-V_S$ | | $+V_S$ | $-V_S$ | | $+V_S$ | V |
| Gain to Output | | | $1 \pm$ 0.0001 | | | $1 \pm$ 0.0001 | | V/V |

| Parameter | Test Conditions/ Comments | A Grade | | | B Grade | | | Unit |
|--|--|---------|-------------|--------------|---------|-------------|--------------|------------------------|
| | | Min | Typ | Max | Min | Typ | Max | |
| GAIN | $G = 1 + (49.4 \text{ k}\Omega/R_G)$ | | | | | | | |
| Gain Range | | 1 | | 1000 | 1 | | 1000 | V/V |
| Gain Error | | | | | | | | |
| G = 1 | $V_{OUT} = 0.3 \text{ V to } 2.9 \text{ V}$ | | | 0.06 | | | 0.04 | % |
| G = 10 | $V_{OUT} = 0.3 \text{ V to } 3.8 \text{ V}$ | | | 0.3 | | | 0.2 | % |
| G = 100 | $V_{OUT} = 0.3 \text{ V to } 3.8 \text{ V}$ | | | 0.3 | | | 0.2 | % |
| G = 1000 | $V_{OUT} = 0.3 \text{ V to } 3.8 \text{ V}$ | | | 0.3 | | | 0.2 | % |
| Nonlinearity | $V_{OUT} = 0.3 \text{ V to } 2.9 \text{ V for } G = 1$ $V_{OUT} = 0.3 \text{ V to } 3.8 \text{ V for } G > 1$ | | | | | | | |
| G = 1 | $R_L = 10 \text{ k}\Omega$ | | 35 | 50 | | 35 | 50 | ppm |
| G = 10 | $R_L = 10 \text{ k}\Omega$ | | 35 | 50 | | 35 | 50 | ppm |
| G = 100 | $R_L = 10 \text{ k}\Omega$ | | 50 | 75 | | 50 | 75 | ppm |
| G = 1000 | $R_L = 10 \text{ k}\Omega$ | | 90 | 115 | | 90 | 115 | ppm |
| G = 1 | $R_L = 2 \text{ k}\Omega$ | | 35 | 50 | | 35 | 50 | ppm |
| G = 10 | $R_L = 2 \text{ k}\Omega$ | | 35 | 50 | | 35 | 50 | ppm |
| G = 100 | $R_L = 2 \text{ k}\Omega$ | | 50 | 75 | | 50 | 75 | ppm |
| G = 1000 | $R_L = 2 \text{ k}\Omega$ | | 175 | 200 | | 175 | 200 | ppm |
| Gain vs. Temperature | | | | | | | | |
| G = 1 | | | 3 | 10 | | 2 | 5 | ppm/°C |
| G > 10 | | | | -50 | | | -50 | ppm/°C |
| INPUT | | | | | | | | |
| Impedance (Pin to Ground) ⁴ | | | $10^4 6$ | | | $10^4 6$ | | $G\Omega \text{pF}$ |
| Input Voltage Range ⁵ | | -0.1 | | $+V_S - 2$ | -0.1 | | $+V_S - 2$ | V |
| Over Temperature | $T = -40^\circ\text{C to } +85^\circ\text{C}$ | -0.1 | | $+V_S - 2.1$ | -0.1 | | $+V_S - 2.1$ | V |
| OUTPUT | | | | | | | | |
| Output Swing | $R_L = 2 \text{ k}\Omega$ | 0.25 | | 4.75 | 0.25 | | 4.75 | V |
| Over Temperature | $T = -40^\circ\text{C to } +85^\circ\text{C}$ | 0.3 | | 4.70 | 0.3 | | 4.70 | V |
| Output Swing | $R_L = 10 \text{ k}\Omega$ | 0.15 | | 4.85 | 0.15 | | 4.85 | V |
| Over Temperature | $T = -40^\circ\text{C to } +85^\circ\text{C}$ | 0.2 | | 4.80 | 0.2 | | 4.80 | V |
| Short-Circuit Current | | | 15 | | | 15 | | mA |
| POWER SUPPLY | | | | | | | | |
| Operating Range | | 4.5 | | 36 | 4.5 | | 36 | V |
| Quiescent Current (Per Amplifier) | | | 750 | 800 | | 750 | 800 | μA |
| Over Temperature | $T = -40^\circ\text{C to } +85^\circ\text{C}$ | | 850 | 900 | | 850 | 900 | μA |
| TEMPERATURE RANGE | | | | | | | | |
| For Specified Performance | | -40 | | +85 | -40 | | +85 | °C |
| Operational ⁶ | | -40 | | +125 | -40 | | +125 | °C |

¹ When the output sinks more than 4 mA, use a 47 pF capacitor in parallel with the load to prevent ringing. Otherwise, use a larger load, such as 10 k Ω .

² Refers to the differential configuration shown in Figure 64.

³ Refer to Figure 15 and Figure 16 for the relationship between input current and temperature.

⁴ Differential and common-mode impedance can be calculated from the pin impedance: $Z_{DIFF} = 2(Z_{PIN})$; $Z_{CM} = Z_{PIN}/2$.

⁵ The AD8224 can operate up to a diode drop below the negative supply, but the bias current increases sharply. The input voltage range reflects the maximum allowable voltage where the input bias current is within the specification.

⁶ The AD8224 is characterized from -40°C to $+125^\circ\text{C}$. See the Typical Performance Characteristics section for expected operation in that temperature range.

$V_{S+} = 5\text{ V}$, $V_{S-} = 0\text{ V}$, $V_{REF} = 2.5\text{ V}$, $T_A = 25^\circ\text{C}$, $G = 1$, $R_L = 2\text{ k}\Omega^1$, unless otherwise noted. Table 6 displays the specifications for the dynamic performance of each individual instrumentation amplifier.

Table 6. Dynamic Performance of Each Individual Amplifier—Single-Ended Output Configuration, $V_S = +5\text{ V}$

| Parameter | Test Conditions/ Comments | A Grade | | | B Grade | | | Unit |
|------------------------------|--------------------------------|---------|------|-----|---------|-----|-----|------------------|
| | | Min | Typ | Max | Min | Typ | Max | |
| DYNAMIC RESPONSE | | | | | | | | |
| Small Signal Bandwidth –3 dB | | | | | | | | |
| G = 1 | | | 1500 | | 1500 | | | kHz |
| G = 10 | | | 800 | | 800 | | | kHz |
| G = 100 | | | 120 | | 120 | | | kHz |
| G = 1000 | | | 14 | | 14 | | | kHz |
| Settling Time 0.01% | | | | | | | | |
| G = 1 | $\Delta V_O = 3\text{ V step}$ | | 2.5 | | 2.5 | | | μs |
| G = 10 | $\Delta V_O = 4\text{ V step}$ | | 2.5 | | 2.5 | | | μs |
| G = 100 | $\Delta V_O = 4\text{ V step}$ | | 7.5 | | 7.5 | | | μs |
| G = 1000 | $\Delta V_O = 4\text{ V step}$ | | 60 | | 60 | | | μs |
| Settling Time 0.001% | | | | | | | | |
| G = 1 | $\Delta V_O = 3\text{ V step}$ | | 3.5 | | 3.5 | | | μs |
| G = 10 | $\Delta V_O = 4\text{ V step}$ | | 3.5 | | 3.5 | | | μs |
| G = 100 | $\Delta V_O = 4\text{ V step}$ | | 8.5 | | 8.5 | | | μs |
| G = 1000 | $\Delta V_O = 4\text{ V step}$ | | 75 | | 75 | | | μs |
| Slew Rate | | | | | | | | |
| G = 1 to 100 | | 2 | | | 2 | | | V/ μs |

¹ When the output sinks more than 4 mA, use a 47 pF capacitor in parallel with the load to prevent ringing. Otherwise, use a larger load, such as 10 k Ω .

$V_{S+} = 5\text{ V}$, $V_{S-} = 0\text{ V}$, $V_{REF} = 2.5\text{ V}$, $T_A = 25^\circ\text{C}$, $G = 1$, $R_L = 2\text{ k}\Omega^1$ unless otherwise noted. Table 7 displays the specifications for the dynamic performance of both amplifiers when used in the differential output configuration shown in Figure 64.

Table 7. Dynamic Performance of Both Amplifiers—Differential Output Configuration², $V_S = +5\text{ V}$

| Parameter | Test Conditions/Comments | A Grade | | | B Grade | | | Unit |
|------------------------------|--------------------------------|---------|------|-----|---------|-----|-----|------------------|
| | | Min | Typ | Max | Min | Typ | Max | |
| DYNAMIC RESPONSE | | | | | | | | |
| Small Signal Bandwidth –3 dB | | | | | | | | |
| G = 1 | | | 1500 | | 1500 | | | kHz |
| G = 10 | | | 800 | | 800 | | | kHz |
| G = 100 | | | 120 | | 120 | | | kHz |
| G = 1000 | | | 14 | | 14 | | | kHz |
| Settling Time 0.01% | | | | | | | | |
| G = 1 | $\Delta V_O = 3\text{ V step}$ | | 2.5 | | 2.5 | | | μs |
| G = 10 | $\Delta V_O = 4\text{ V step}$ | | 2.5 | | 2.5 | | | μs |
| G = 100 | $\Delta V_O = 4\text{ V step}$ | | 7.5 | | 7.5 | | | μs |
| G = 1000 | $\Delta V_O = 4\text{ V step}$ | | 60 | | 60 | | | μs |
| Settling Time 0.001% | | | | | | | | |
| G = 1 | $\Delta V_O = 3\text{ V step}$ | | 3.5 | | 3.5 | | | μs |
| G = 10 | $\Delta V_O = 4\text{ V step}$ | | 3.5 | | 3.5 | | | μs |
| G = 100 | $\Delta V_O = 4\text{ V step}$ | | 8.5 | | 8.5 | | | μs |
| G = 1000 | $\Delta V_O = 4\text{ V step}$ | | 75 | | 75 | | | μs |
| Slew Rate | | | | | | | | |
| G = 1 to 100 | | 2 | | | 2 | | | V/ μs |

¹ When the output sinks more than 4 mA, use a 47 pF capacitor in parallel with the load to prevent ringing. Otherwise, use a larger load, such as 10 k Ω .

² Refers to the differential configuration shown in Figure 64.

ABSOLUTE MAXIMUM RATINGS

Table 8.

| Parameter | Rating |
|--|-------------------------|
| Supply Voltage | ±18 V |
| Power Dissipation | See Figure 2 |
| Output Short-Circuit Current | Indefinite ¹ |
| Input Voltage (Common Mode) | ±V _S |
| Differential Input Voltage | ±V _S |
| Storage Temperature Range | −65°C to +130°C |
| Operating Temperature Range ² | −40°C to +125°C |
| Lead Temperature (Soldering, 10 sec) | 300°C |
| Junction Temperature | 130°C |
| Package Glass Transition Temperature | 130°C |
| ESD (Human Body Model) | 4 kV |
| ESD (Charge Device Model) | 1 kV |
| ESD (Machine Model) | 0.4 kV |

¹ Assumes the load is referenced to midsupply.

² Temperature for specified performance is −40°C to +85°C. For performance to 125°C, see the Typical Performance Characteristics section.

Stresses at or above those listed under Absolute Maximum Ratings may cause permanent damage to the product. This is a stress rating only; functional operation of the product at these or any other conditions above those indicated in the operational section of this specification is not implied. Operation beyond the maximum operating conditions for extended periods may affect product reliability.

THERMAL RESISTANCE

Table 9.

| Exposed Pad Package | θ _{JA} | Unit |
|---|-----------------|------|
| CP-16-26: LFCSP, EPAD Soldered to Board | 48 | °C/W |
| CP-16-26: LFCSP, EPAD Not Soldered to Board | 86 | °C/W |

Table 10.

| Hidden Paddle Package | θ _{JA} | Unit |
|-----------------------|-----------------|------|
| CP-16-19: LFCSP | 86 | °C/W |

The θ_{JA} values in Table 9 and Table 10 assume a 4-layer JEDEC standard board. If the thermal pad is soldered to the board, it is also assumed it is connected to a plane. θ_{JC} at the exposed pad is 4.4°C/W.

Maximum Power Dissipation

The maximum safe power dissipation for the AD8224 is limited by the associated rise in junction temperature (T_J) on the die. At approximately 130°C, which is the glass transition temperature, the plastic changes its properties. Even temporarily exceeding this temperature limit may change the stresses that the package exerts on the die, permanently shifting the parametric performance of the amplifiers. Exceeding a temperature of 130°C for an extended period can result in a loss of functionality. Figure 2 shows the maximum safe power dissipation in the package vs. the ambient temperature for the LFCSP on a 4-layer JEDEC standard board.



Figure 2. Maximum Power Dissipation vs. Ambient Temperature

ESD CAUTION



ESD (electrostatic discharge) sensitive device. Charged devices and circuit boards can discharge without detection. Although this product features patented or proprietary protection circuitry, damage may occur on devices subjected to high energy ESD. Therefore, proper ESD precautions should be taken to avoid performance degradation or loss of functionality.

PIN CONFIGURATIONS AND FUNCTION DESCRIPTIONS

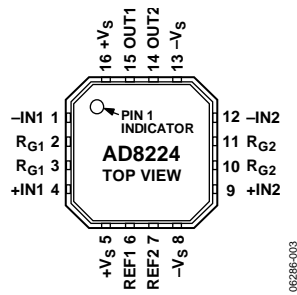

Figure 3. 16-Lead LFCSP Pin Configuration with Hidden Paddle

Table 11. Pin Function Descriptions

| Pin Number | Mnemonic | Description |
|------------|----------|---|
| 1 | -IN1 | Negative Input Instrumentation Amplifier (In-Amp) 1 |
| 2 | R_{G1} | Gain Resistor In-Amp 1 |
| 3 | R_{G1} | Gain Resistor In-Amp 1 |
| 4 | +IN1 | Positive Input In-Amp 1 |
| 5 | + V_S | Positive Supply |
| 6 | REF1 | Reference Adjust In-Amp 1 |
| 7 | REF2 | Reference Adjust In-Amp 2 |
| 8 | - V_S | Negative Supply |
| 9 | +IN2 | Positive Input In-Amp 2 |
| 10 | R_{G2} | Gain Resistor In-Amp 2 |
| 11 | R_{G2} | Gain Resistor In-Amp 2 |
| 12 | -IN2 | Negative Input In-Amp 2 |
| 13 | - V_S | Negative Supply |
| 14 | OUT2 | Output In-Amp 2 |
| 15 | OUT1 | Output In-Amp 1 |
| 16 | + V_S | Positive Supply |



NOTES

1. THE EXPOSED THERMAL PAD IS CONNECTED INTERNALLY TO +V_S. THE PAD CAN EITHER BE LEFT UNCONNECTED OR CONNECTED TO THE POSITIVE SUPPLY RAIL.

06286-1/04

Figure 4. 16-Lead LFCSP Pin Configuration with Exposed Pad

Table 12. Pin Function Descriptions

| Pin Number | Mnemonic | Description |
|------------|-----------------|--|
| 1 | -IN1 | Negative Input In-Amp 1. |
| 2 | R _{G1} | Gain Resistor In-Amp 1. |
| 3 | R _{G1} | Gain Resistor In-Amp 1. |
| 4 | +IN1 | Positive Input In-Amp 1. |
| 5 | +V _S | Positive Supply. |
| 6 | REF1 | Reference Adjust In-Amp 1. |
| 7 | REF2 | Reference Adjust In-Amp 2. |
| 8 | -V _S | Negative Supply. |
| 9 | +IN2 | Positive Input In-Amp 2. |
| 10 | R _{G2} | Gain Resistor In-Amp 2. |
| 11 | R _{G2} | Gain Resistor In-Amp 2. |
| 12 | -IN2 | Negative Input In-Amp 2. |
| 13 | -V _S | Negative Supply. |
| 14 | OUT2 | Output In-Amp 2. |
| 15 | OUT1 | Output In-Amp 1. |
| 16 | +V _S | Positive Supply. |
| | EPAD | Exposed Pad. The exposed thermal pad is connected internally to +V _S . The pad can either be left unconnected or connected to the positive supply rail. |

TYPICAL PERFORMANCE CHARACTERISTICS

25°C, $V_S = \pm 15\text{ V}$, $R_L = 10\text{ k}\Omega$, unless otherwise noted.



Figure 5. Typical Distribution of CMRR (G = 1)

06286-070

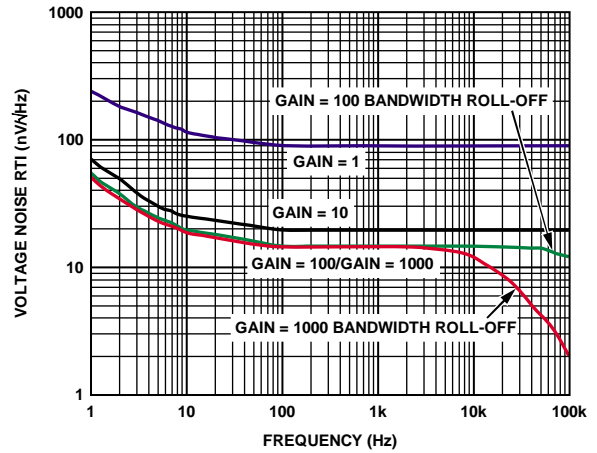

Figure 8. Voltage Spectral Density vs. Frequency

06286-009



Figure 6. Typical Distribution of Input Offset Voltage

06286-071



Figure 9. 0.1 Hz to 10 Hz RTI Voltage Noise (G = 1)

06286-010

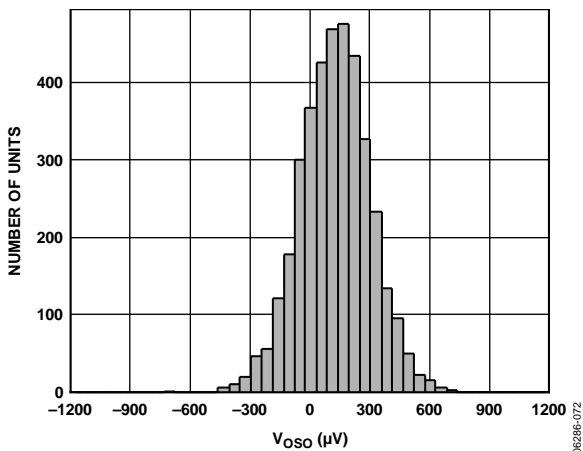

Figure 7. Typical Distribution of Output Offset Voltage

06286-072

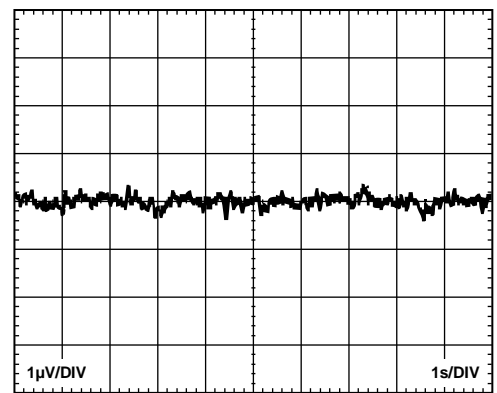

Figure 10. 0.1 Hz to 10 Hz RTI Voltage Noise (G = 1000)

06286-011



Figure 11. Change in Input Offset Voltage vs. Warmup Time



Figure 14. Input Bias Current and Input Offset Current vs. Common-Mode Voltage



Figure 12. Positive PSRR vs. Frequency, RTI



Figure 15. Input Bias Current and Offset Current vs. Temperature, $V_S = \pm 15 V, V_{REF} = 0 V$



Figure 13. Negative PSRR vs. Frequency, RTI



Figure 16. Input Bias Current and Offset Current vs. Temperature, $V_S = 5 V, V_{REF} = 2.5 V$



Figure 17. CMRR vs. Frequency

06286-018

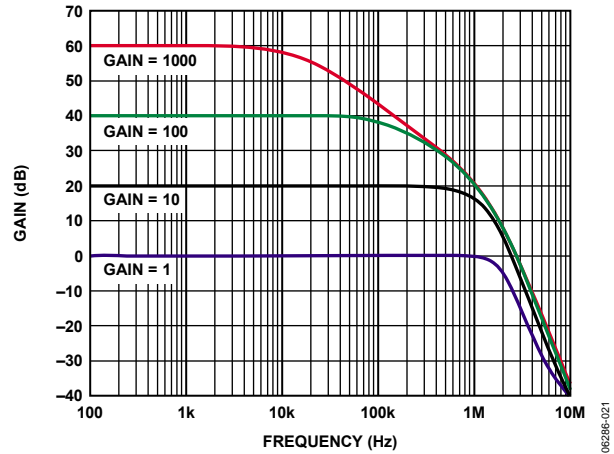

Figure 20. Gain vs. Frequency

06286-021



Figure 18. CMRR vs. Frequency, 1 kΩ Source Imbalance

06286-019



Figure 21. Gain Nonlinearity, G = 1

06286-022



Figure 19. Change in CMRR vs. Temperature, G = 1

06286-020

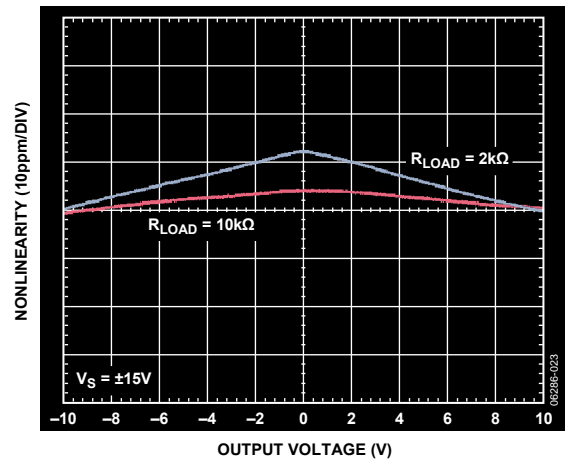

Figure 22. Gain Nonlinearity, G = 10

06286-023



Figure 23. Gain Nonlinearity, $G = 100$



Figure 24. Gain Nonlinearity, $G = 1000$



Figure 25. Input Common-Mode Voltage Range vs. Output Voltage, $G = 1, V_{REF} = 0V$



Figure 26. Input Common-Mode Voltage Range vs. Output Voltage, $G = 1, V_S = 5V, V_{REF} = 2.5V$

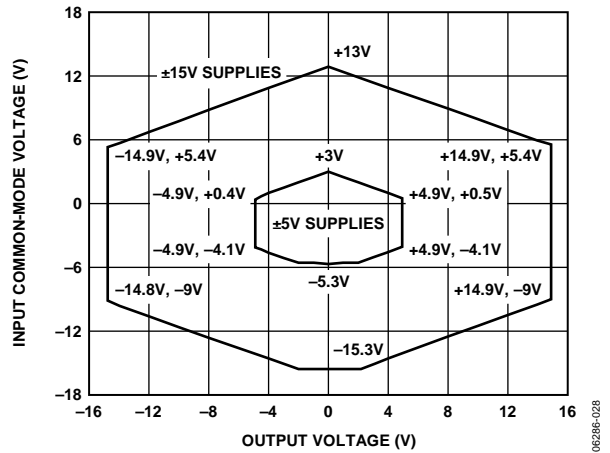

Figure 27. Input Common-Mode Voltage Range vs. Output Voltage, $G = 100, V_{REF} = 0V$



Figure 28. Input Common-Mode Voltage Range vs. Output Voltage, $G = 100, V_S = 5V, V_{REF} = 2.5V$



Figure 29. Input Voltage Limit vs. Supply Voltage, $G = 1$, $V_{REF} = 0V$

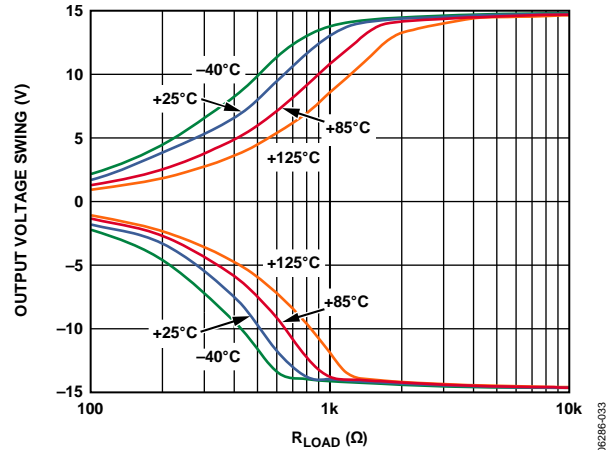

Figure 32. Output Voltage Swing vs. Load Resistance, $V_S = \pm 15V$, $V_{REF} = 0V$



Figure 30. Output Voltage Swing vs. Dual Supply Voltage, $R_{LOAD} = 2k\Omega$, $G = 10$, $V_{REF} = 0V$



Figure 33. Output Voltage Swing vs. Load Resistance, $V_S = 5V$, $V_{REF} = 2.5V$



Figure 31. Output Voltage Swing vs. Dual Supply Voltage, $R_{LOAD} = 10k\Omega$, $G = 10$, $V_{REF} = 0V$

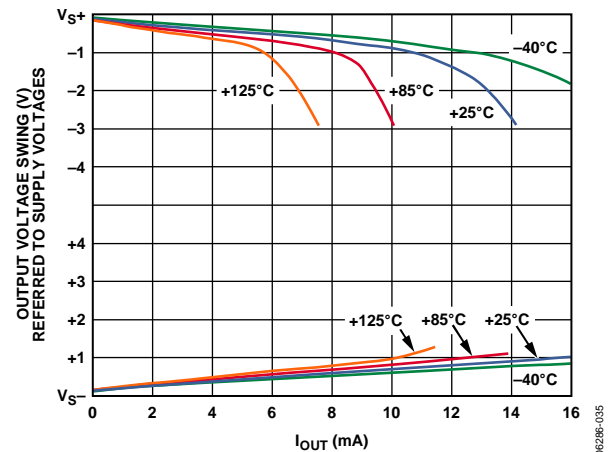

Figure 34. Output Voltage Swing vs. Output Current, $V_S = \pm 15V$, $V_{REF} = 0V$



Figure 35. Output Voltage Swing vs. Output Current, $V_S = 5\text{ V}$, $V_{REF} = 2.5\text{ V}$



Figure 38. Output Voltage Swing vs. Large Signal Frequency Response

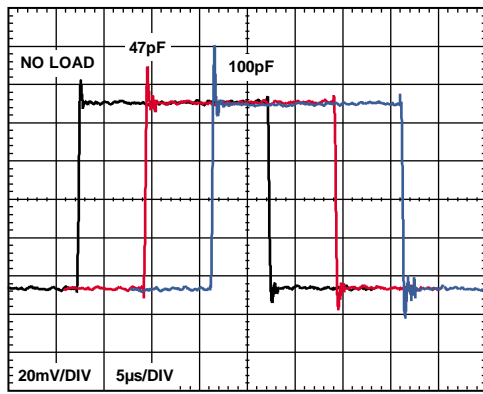

Figure 36. Small Signal Pulse Response for Various Capacitive Loads, $V_S = \pm 15\text{ V}$, $V_{REF} = 0\text{ V}$



Figure 37. Small Signal Pulse Response for Various Capacitive Loads, $V_S = 5\text{ V}$, $V_{REF} = 2.5\text{ V}$

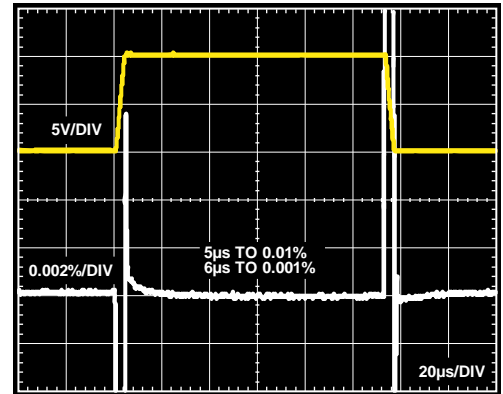
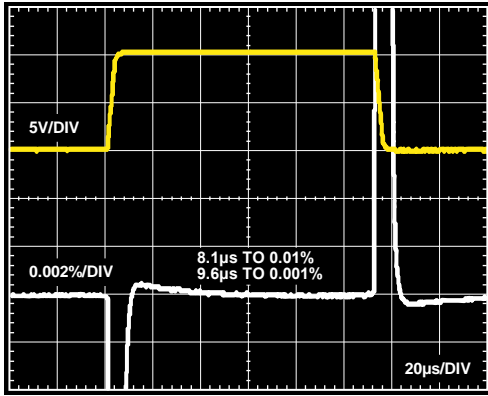

Figure 39. Large Signal Pulse Response and Settle Time, $G = 1$, $R_{LOAD} = 10\text{ k}\Omega$, $V_S = \pm 15\text{ V}$, $V_{REF} = 0\text{ V}$

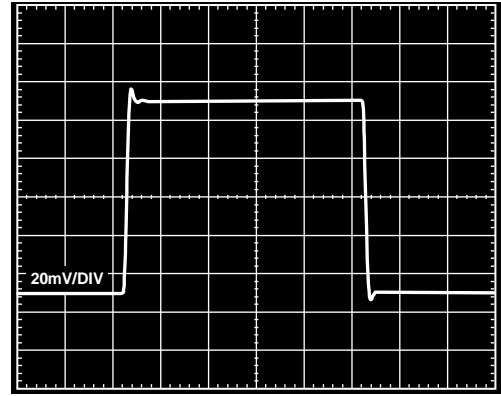

Figure 40. Large Signal Pulse Response and Settle Time, $G = 10$, $R_{LOAD} = 10\text{ k}\Omega$, $V_S = \pm 15\text{ V}$, $V_{REF} = 0\text{ V}$



06286-042

Figure 41. Large Signal Pulse Response and Settle Time, $G = 100$, $R_{LOAD} = 10\text{ k}\Omega$, $V_S = \pm 15\text{ V}$, $V_{REF} = 0\text{ V}$



06286-045

Figure 44. Small Signal Pulse Response, $G = 10$, $R_{LOAD} = 2\text{ k}\Omega$, $C_{LOAD} = 100\text{ pF}$, $V_S = \pm 15\text{ V}$, $V_{REF} = 0\text{ V}$

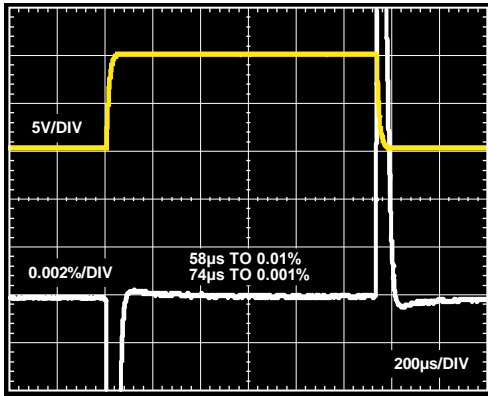

06286-043

Figure 42. Large Signal Pulse Response and Settle Time, $G = 1000$, $R_{LOAD} = 10\text{ k}\Omega$, $V_S = \pm 15\text{ V}$, $V_{REF} = 0\text{ V}$

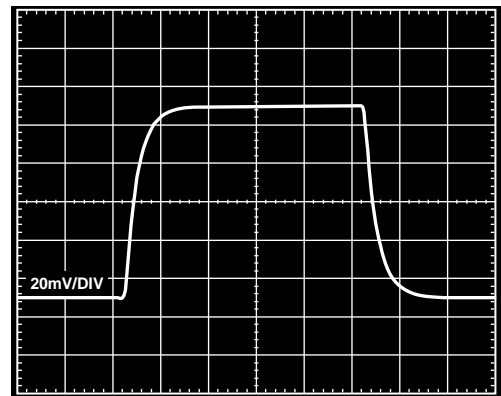

06286-046

Figure 45. Small Signal Pulse Response, $G = 100$, $R_{LOAD} = 2\text{ k}\Omega$, $C_{LOAD} = 100\text{ pF}$, $V_S = \pm 15\text{ V}$, $V_{REF} = 0\text{ V}$

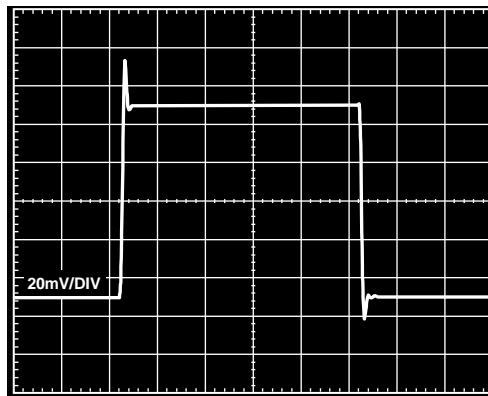

06286-044

Figure 43. Small Signal Pulse Response, $G = 1$, $R_{LOAD} = 2\text{ k}\Omega$, $C_{LOAD} = 100\text{ pF}$, $V_S = \pm 15\text{ V}$, $V_{REF} = 0\text{ V}$

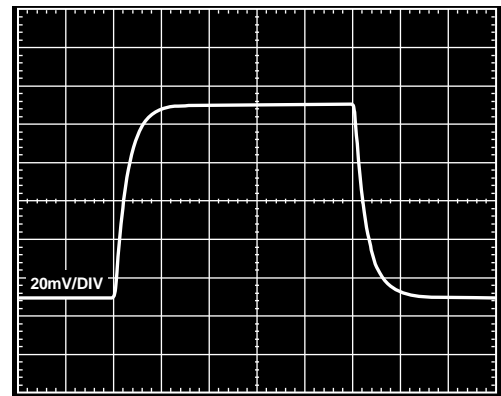

06286-047

Figure 46. Small Signal Pulse Response, $G = 1000$, $R_{LOAD} = 2\text{ k}\Omega$, $C_{LOAD} = 100\text{ pF}$, $V_S = \pm 15\text{ V}$, $V_{REF} = 0\text{ V}$



06286-048

Figure 47. Small Signal Pulse Response, $G = 1$, $R_{LOAD} = 2\text{ k}\Omega$, $C_{LOAD} = 100\text{ pF}$, $V_S = 5\text{ V}$, $V_{REF} = 2.5\text{ V}$

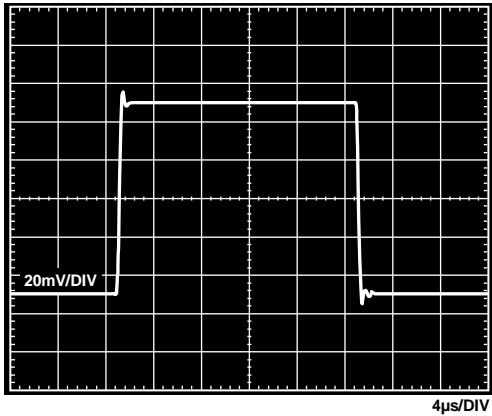

06286-049

Figure 48. Small Signal Pulse Response, $G = 10$, $R_{LOAD} = 2\text{ k}\Omega$, $C_{LOAD} = 100\text{ pF}$, $V_S = 5\text{ V}$, $V_{REF} = 2.5\text{ V}$

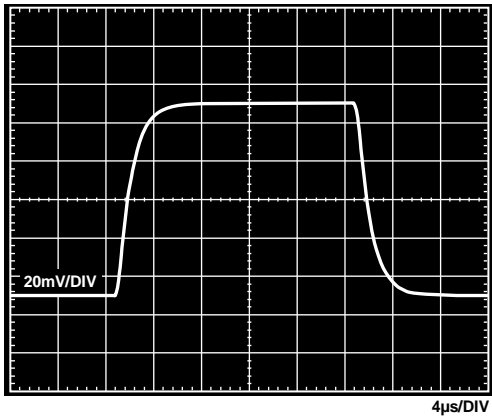

06286-050

Figure 49. Small Signal Pulse Response, $G = 100$, $R_{LOAD} = 2\text{ k}\Omega$, $C_{LOAD} = 100\text{ pF}$, $V_S = 5\text{ V}$, $V_{REF} = 2.5\text{ V}$

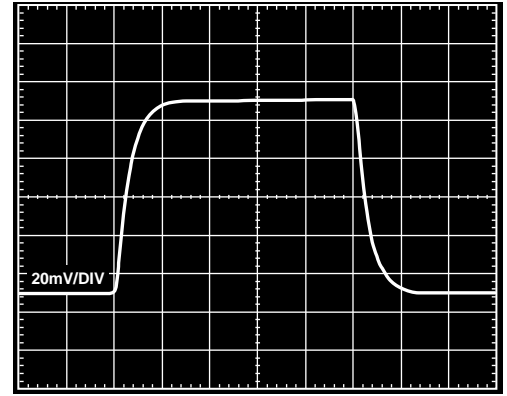

06286-051

Figure 50. Small Signal Pulse Response, $G = 1000$, $R_{LOAD} = 2\text{ k}\Omega$, $C_{LOAD} = 100\text{ pF}$, $V_S = 5\text{ V}$, $V_{REF} = 2.5\text{ V}$

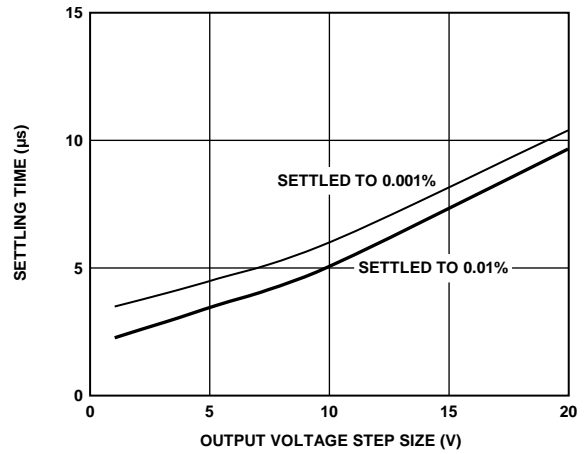

06286-052

Figure 51. Settling Time vs. Output Voltage Step Size, $(G = 1) \pm 15\text{ V}$, $V_{REF} = 0\text{ V}$

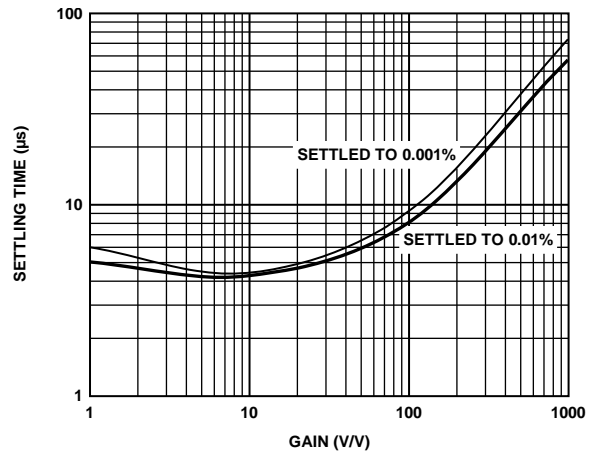

06286-053

Figure 52. Settling Time vs. Gain for a 10V Step, $V_S = \pm 15\text{ V}$, $V_{REF} = 0\text{ V}$



Figure 53. Channel Separation vs. Frequency, $R_{LOAD} = 2\text{ k}\Omega$, Source Channel at $G = 1$



Figure 55. Differential Output Configuration: Common-Mode Output (CMR_{OUT}) vs. Frequency



Figure 54. Differential Output Configuration: Gain vs. Frequency

06286-059

06286-056

06286-055

THEORY OF OPERATION



Figure 56. Simplified Schematic

06286-057

The **AD8224** is a JFET input, monolithic instrumentation amplifier based on the classic three op amp topology (see Figure 56). Input Transistor J1 and Input Transistor J2 are biased at a fixed current so that any input signal forces the output voltages of A1 and A2 to change accordingly. The input signal creates a current through R_G that flows in R1 and R2 such that the outputs of A1 and A2 provide the correct, gained signal. Topologically, J1, A1, and R1 and J2, A2, and R2 can be viewed as precision current feedback amplifiers. The common-mode voltage and amplified differential signal from A1 and A2 are applied to a difference amplifier that rejects the common-mode voltage but amplifies the differential signal. The difference amplifier employs 20 kΩ laser trimmed resistors that result in an in-amp with a gain error of less than 0.04%. New trim techniques were developed to ensure that the CMRR exceeds 86 dB ($G = 1$).

Using JFET transistors, the **AD8224** offers an extremely high input impedance, extremely low bias currents of 10 pA maximum, low offset current of 0.6 pA maximum, and no input bias current noise. In addition, input offset is less than 175 μ V and drift is less than 5 μ V/ $^{\circ}$ C. Ease of use and robustness were considered. A common problem for instrumentation amplifiers is that at high gains, when the input is overdriven, an excessive milliampere input bias current can result, and the output can undergo phase reversal.

Overdriving the input at high gains refers to when the input signal is within the supply voltages but the amplifier cannot output the gained signal. For example, at a gain of 100, driving the amplifier with 10 V on ± 15 V constitutes overdriving the inputs because the amplifier cannot output 100 V.

The **AD8224** has none of these problems; its input bias current is limited to less than 10 μ A, and the output does not phase reverse under overdrive fault conditions.

The **AD8224** has extremely low load induced nonlinearity. All amplifiers that comprise the **AD8224** have rail-to-rail output capability for enhanced dynamic range. The input of the **AD8224** can amplify signals with wide common-mode voltages even slightly lower than the negative supply rail. The **AD8224** operates over a wide supply voltage range. It can operate from either a single +4.5 V to +36 V supply or a dual ± 2.25 V to ± 18 V. The transfer function of the **AD8224** is

$$G = 1 + \frac{49.4 \text{ k}\Omega}{R_G}$$

Users can easily and accurately set the gain using a single, standard resistor. Because the input amplifiers employ a current feedback architecture, the **AD8224** gain bandwidth product increases with gain, resulting in a system that does not experience as much bandwidth loss as voltage feedback architectures at higher gains.

GAIN SELECTION

Placing a resistor across the R_G terminals sets the gain of the **AD8224**. This is calculated by referring to Table 13 or by using the following gain equation

$$R_G = \frac{49.4 \text{ k}\Omega}{G - 1}$$

Table 13. Gains Achieved Using 1% Resistors

| 1% Standard Table Value of R_G (Ω) | Calculated Gain |
|---|-----------------|
| 49.9 k | 1.990 |
| 12.4 k | 4.984 |
| 5.49 k | 9.998 |
| 2.61 k | 19.93 |
| 1.00 k | 50.40 |
| 499 | 100.0 |
| 249 | 199.4 |
| 100 | 495.0 |
| 49.9 | 991.0 |

The AD8224 defaults to $G = 1$ when no gain resistor is used. The tolerance and gain drift of the R_G resistor should be added to the AD8224 specifications to determine the total gain accuracy of the system. When the gain resistor is not used, gain error and gain drift are kept to a minimum.

REFERENCE TERMINAL

The output voltage of the AD8224 is developed with respect to the potential on the reference terminal. This is useful when the output signal needs to be offset to a precise midsupply level. For example, a voltage source can be tied to the REF1 pin or the REF2 pin to level-shift the output so that the AD8224 can drive a single-supply ADC. Pin REFx is protected with ESD diodes and should not exceed either $+V_S$ or $-V_S$ by more than 0.5 V.

For best performance, source impedance to the REF terminal should be kept below 1Ω . As shown in Figure 56, the reference terminal, REF, is at one end of a $20 \text{ k}\Omega$ resistor. Additional impedance at the REF terminal adds to this $20 \text{ k}\Omega$ resistor and results in amplification of the signal connected to the positive input. The amplification from the additional R_{REF} can be computed by

$$\frac{2(20 \text{ k}\Omega + R_{REF})}{40 \text{ k}\Omega + R_{REF}}$$

Only the positive signal path is amplified; the negative path is unaffected. This uneven amplification degrades the CMRR of the amplifier.



Figure 57. Driving the Reference Pin

LAYOUT

The AD8224 is a high precision device. To ensure optimum performance at the PCB level, care must be taken in the design of the board layout. The AD8224 pinout is arranged in a logical manner to aid in this task.

Package Considerations

The AD8224 is available in two versions of the 16-lead, $4 \text{ mm} \times 4 \text{ mm}$ LFCSP package: with or without an exposed pad. Blindly copying the footprint from another $4 \text{ mm} \times 4 \text{ mm}$ LFCSP part is not recommended because it may not have the same thermal pad size and leads. Refer to the Outline Dimensions section to verify that the PCB symbol has the correct dimensions.

Hidden Paddle Package

The AD8224 is available in an LFCSP package with a hidden paddle. It is the preferred package for the AD8224. Unlike chip scale packages where the pad limits routing capability, this package allows routes and vias directly underneath the chip, so that the full space savings of the small LFCSP can be realized. Although the package has no metal in the center of the part, the manufacturing process does leave a very small section of exposed metal at each of the package corners, shown in Figure 58 as well as Figure 69 in the Outline Dimensions section. This metal is connected to $+V_S$ through the part. Because of a possibility of a short, vias should not be placed underneath these exposed metal tabs.



NOTES
1. EXPOSED LEAD FRAME TABS AT THE FOUR CORNERS OF THE PACKAGE ARE INTERNALLY CONNECTED TO $+V_S$. REFER TO THE OUTLINE DIMENSIONS PAGE, FOR FURTHER INFORMATION ON PACKAGE AVAILABILITY.

06296-01

Figure 58. Hidden Paddle Package: Bottom View

Exposed Pad Package

The AD8224 $4 \text{ mm} \times 4 \text{ mm}$ LFCSP is also available with an exposed thermal pad package version. This pad is connected internally to $+V_S$. The pad can either be left unconnected or connected to the positive supply rail. Space between the leads and thermal pad should be kept as wide as possible for the best bias current performance. To maintain the AD8224 ultralow bias current performance, the thermal pad area can be reduced to extend the gap between the leads and the pad. The exposed pad package also has exposed lead frame tabs at the corners of the package, similar to those of the hidden paddle package, which are internally connected to $+V_S$. Do not place vias underneath these metal tabs.

To preserve maximum pin compatibility with other dual instrumentation amplifiers, such as the AD8222, leave the pad unconnected. This can be done by not soldering the paddle at all or by soldering the part to a landing that is not connected to any other net. For high vibration applications, a landing is recommended.

Because the AD8224 dissipates little power, heat dissipation is rarely an issue. If improved heat dissipation is desired (for example, when driving heavy loads), connect the exposed pad to the positive supply rail. For the best heat dissipation performance, the positive supply rail should be a plane in the board. See the Thermal Resistance section for more information.

Common-Mode Rejection over Frequency

The AD8224 has a higher CMRR over frequency than typical in-amps, which gives it greater immunity to disturbances, such as line noise and its associated harmonics. A well-implemented layout is required to maintain this high performance. Input source impedances should be matched closely. Source resistance should be placed close to the inputs so that it interacts with as little parasitic capacitance as possible.

Parasitics at the R_{Gx} pins can also affect CMRR over frequency. The PCB should be laid out so that the parasitic capacitances at each pin match. Traces from the gain setting resistor to the R_{Gx} pins should be kept short to minimize parasitic inductance.

Reference

Errors introduced at the reference terminal feed directly to the output. Take care to tie the REFx pins to the appropriate local ground.

Power Supplies

A stable dc voltage should be used to power the instrumentation amplifier. Noise on the supply pins can adversely affect performance.

The AD8224 has two positive supply pins (Pin 5 and Pin 16) and two negative supply pins (Pin 8 and Pin 13). While the part functions with only one pin from each supply pair connected, both pins should be connected for specified performance and optimum reliability.

The AD8224 should be decoupled with 0.1 μF bypass capacitors, one for each supply. Place the positive supply decoupling capacitor near Pin 16, and the negative supply decoupling capacitor near Pin 8. Each supply should also be decoupled with a 10 μF tantalum capacitor. The tantalum capacitor can be placed further away from the AD8224 and can generally be shared by other precision integrated circuits. Figure 59 shows an example layout.



Figure 59. Example Layout

06296-059

SOLDER WASH

The solder process can leave flux and other contaminants on the board. When these contaminants are between the AD8224 leads and thermal pad, they can create leakage paths that are larger than the AD8224 bias currents. A thorough washing process removes these contaminants and restores the device's excellent bias current performance.

INPUT BIAS CURRENT RETURN PATH

The input bias current of the AD8224 must have a return path to common. When the source, such as a transformer, cannot provide a return current path, one should be created, as shown in Figure 60.

INPUT PROTECTION

All terminals of the AD8224 are protected against ESD. ESD protection is guaranteed to 4 kV (human body model). In addition, the input structure allows for dc overload conditions a diode drop above the positive supply and a diode drop below the negative supply. Voltages beyond a diode drop of the supplies cause the ESD diodes to conduct and enable current to flow through the diode. Therefore, an external resistor should be used in series with each of the inputs to limit current for voltages beyond the supplies. In either scenario, the AD8224 safely handles a continuous 6 mA current at room temperature.

For applications where the AD8224 encounters extreme overload voltages, as in cardiac defibrillators, external series resistors and low leakage diode clamps, such as BAV199Ls, FJH1100s, or SP720s, should be used.



Figure 60. Creating an IBIAS Path

RF INTERFERENCE

RF rectification is often a problem in applications where there are large RF signals. The problem appears as a small dc offset voltage. The AD8224 by its nature has a 5 pF gate capacitance (CG) at its inputs. Matched series resistors form a natural low-pass filter that reduces rectification at high frequency (see Figure 61).



Figure 61. RFI Filtering Without External Capacitors

The relationship between external, matched series resistors and the internal gate capacitance is expressed as

$$FilterFreq_{DIFF} = \frac{1}{2\pi RC_G}$$

$$FilterFreq_{CM} = \frac{1}{2\pi RC_G}$$

To eliminate high frequency common-mode signals while using smaller source resistors, a low-pass RC network can be placed at the input of the instrumentation amplifier (see Figure 62). The filter limits the input signal bandwidth according to the following relationship:

$$FilterFreq_{DIFF} = \frac{1}{2\pi R(2 C_D + C_C + C_G)}$$

$$FilterFreq_{CM} = \frac{1}{2\pi R(C_C + C_G)}$$

Mismatched CC capacitors result in mismatched low-pass filters. The imbalance causes the AD8224 to treat what would have been a common-mode signal as a differential signal. To reduce the effect of mismatched external CC capacitors, select a value of CD greater than 10 times CC. This sets the differential filter frequency lower than the common-mode frequency.

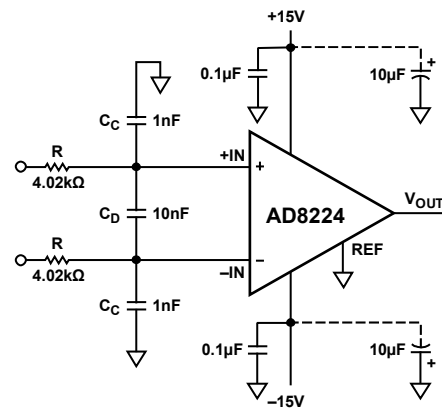

Figure 62. RFI Suppression

COMMON-MODE INPUT VOLTAGE RANGE

The 3-op amp architecture of the AD8224 applies gain and then removes the common-mode voltage. Therefore, internal nodes in the AD8224 experience a combination of both the gained signal and the common-mode signal. This combined signal can be limited by the voltage supplies even when the individual input and output signals are not. Figure 25 through Figure 28 show the allowable common-mode input voltage ranges for various output voltages, supply voltages, and gains.

APPLICATIONS INFORMATION

DRIVING AN ADC

An instrumentation amplifier is often used in front of an ADC to provide CMRR and additional conditioning such as a voltage level shift and gain (see Figure 63). In this example, a 2.7 nF capacitor and a 500 Ω resistor create an antialiasing filter for the AD7685. The 2.7 nF capacitor also serves to store and deliver the necessary charge to the switched capacitor input of the ADC. The 500 Ω series resistor reduces the burden of the 2.7 nF load from the amplifier. However, large source impedance in front of the ADC can degrade the total harmonic distortion (THD).

For applications where THD performance is critical, the series resistor needs to be small. At worst, a small series resistor can load the AD8224, potentially causing the output to overshoot or ring. In such cases, a buffer amplifier, such as the AD8615 should be used after the AD8224 to drive the ADC.



Figure 63. Driving an ADC in a Low Frequency Application

DIFFERENTIAL OUTPUT

The differential configuration of the AD8224 has the same excellent dc precision specifications as the single-ended output configuration and is recommended for applications in the frequency range of dc to 1 MHz.

The circuit configuration, outlined in Table 4 and Table 7, refers to the configuration shown in Figure 64 only. The circuit includes an RC filter that maintains the stability of the loop.

The transfer function for the differential output is

$$V_{DIFF_OUT} = V_{+OUT} - V_{-OUT} = (V_{+IN} - V_{-IN}) \times G$$

where:

$$G = 1 + \frac{49.4 \text{ k}\Omega}{R_G}$$



Figure 64. Differential Circuit Schematic

Setting the Common-Mode Voltage

The output common-mode voltage is set by the average of +IN2 and REF2. The transfer function is

$$V_{CM_OUT} = (V_{+OUT} + V_{-OUT})/2 = (V_{+IN2} + V_{REF2})/2$$

+IN2 and REF2 have different properties that allow the reference voltage to be easily set for a wide variety of applications. +IN2 has high impedance but cannot swing to the positive supply rail. REF2 must be driven with a low impedance but can go 300 mV beyond the supply rails.

A common application sets the common-mode output voltage to the midscale of a differential ADC. In this case, the ADC reference voltage is sent to the +IN2 terminal, and ground is connected to the REF2 terminal. This produces a common-mode output voltage of half the ADC reference voltage.

2-Channel Differential Output Using a Dual Op Amp

Another differential output topology is shown in Figure 65. Instead of a second in-amp, ½ of a dual OP2177 op amp creates the inverted output. Because the OP2177 comes in an MSOP, this configuration allows the creation of a dual-channel, precision differential output in-amp with little board area.

Errors from the op amp are common to both outputs and are, thus, common mode. Errors from mismatched resistors also create a common-mode dc offset. Because these errors are common mode, they are likely to be rejected by the next device in the signal chain.

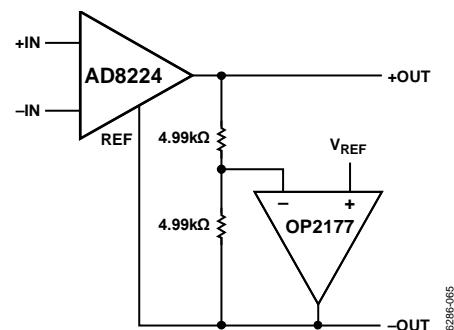

Figure 65. Differential Output Using Op Amp

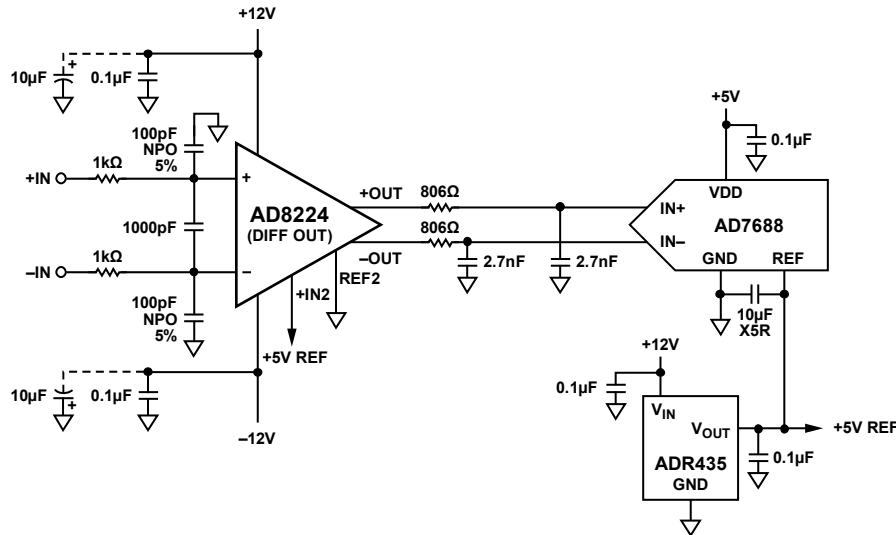

Figure 66. Driving a Differential ADC

DRIVING A DIFFERENTIAL INPUT ADC

The [AD8224](#) can be configured in differential output mode to drive a differential ADC. Figure 66 illustrates several of the concepts.

First Antialiasing Filter

The 1 kΩ resistor, 1000 pF capacitor, and 100 pF capacitors in front of the in-amp form a 76 kHz filter. This is the first of two antialiasing filters in the circuit and helps to reduce the noise of the system. The 100 pF capacitors protect against common-mode RFI signals. Note that they are 5% COG/NPO types. These capacitors match well over time and temperature, which keeps the CMRR of the system high over frequency.

Second Antialiasing Filter

An 806 Ω resistor and a 2.7 nF capacitor are located between each [AD8224](#) output and ADC input. These components create a 73 kHz low-pass filter for another stage of antialiasing protection.

These four elements also isolate the ADC from loading the [AD8224](#). The 806 Ω resistor shields the [AD8224](#) from the switched capacitor input of the ADC, which looks like a time-varying load. The 2.7 nF capacitor provides a charge to the switched capacitor front end of the ADC. If the application requires a lower frequency antialiasing filter, increase the value of the capacitor rather than the resistor.

The 806 Ω resistors can also protect an ADC from overvoltages. Because the [AD8224](#) runs on wider supply voltages than a typical ADC, there is a possibility of overdriving the ADC. This is not an issue with a PulSAR® converter, such as the [AD7688](#). Its input can handle a 130 mA overdrive, which is much higher than the short-circuit limit of the [AD8224](#).

However, other converters have less robust inputs and may need the added protection.

Reference

The [ADR435](#) supplies a reference voltage to both the ADC and the [AD8224](#). Because REF2 on the [AD8224](#) is grounded, the common-mode output voltage is precisely half the reference voltage, exactly where it needs to be for the ADC.

DRIVING CABLING

All cables have a certain capacitance per unit length, which varies widely with cable type. The capacitive load from the cable may cause peaking in the [AD8224](#) output response. To reduce peaking, use a resistor between the [AD8224](#) and the cable. Because cable capacitance and desired output response vary widely, this resistor is best determined empirically. A good starting point is 50 Ω.

The [AD8224](#) operates at a low enough frequency that transmission line effects are rarely an issue; therefore, the resistor need not match the characteristic impedance of the cable.

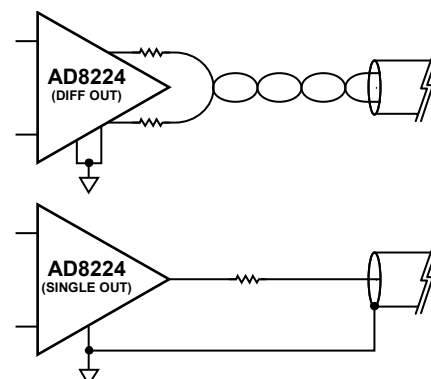

Figure 67. Driving a Cable

OUTLINE DIMENSIONS



COMPLIANT TO JEDEC STANDARDS MO-220-WGGC.

Figure 68. 16-Lead Lead Frame Chip Scale Package [LFCSP]
4 mm × 4 mm Body and 0.75 mm Package Height
(CP-16-26)

Dimensions are shown in millimeters

042709-A



COMPLIANT TO JEDEC STANDARDS MO-263-VBBC

Figure 69. 16-Lead Lead Frame Chip Scale Package [LFCSP]
4 mm × 4 mm Body and 0.85 mm Package Height, with Hidden Paddle
(CP-16-19)

Dimensions shown in millimeters

04-06-2012-A

ORDERING GUIDE

| Model ¹ | Temperature Range | Package Description | Package Option |
|--------------------|-------------------|---|----------------|
| AD8224ACPZ-R7 | –40°C to +85°C | 16-Lead Lead Frame Chip Scale Package [LFCSP] | CP-16-26 |
| AD8224ACPZ-RL | –40°C to +85°C | 16-Lead Lead Frame Chip Scale Package [LFCSP] | CP-16-26 |
| AD8224ACPZ-WP | –40°C to +85°C | 16-Lead Lead Frame Chip Scale Package [LFCSP] | CP-16-26 |
| AD8224BCPZ-R7 | –40°C to +85°C | 16-Lead Lead Frame Chip Scale Package [LFCSP] | CP-16-26 |
| AD8224BCPZ-RL | –40°C to +85°C | 16-Lead Lead Frame Chip Scale Package [LFCSP] | CP-16-26 |
| AD8224BCPZ-WP | –40°C to +85°C | 16-Lead Lead Frame Chip Scale Package [LFCSP] | CP-16-26 |
| AD8224HACPZ-R7 | –40°C to +85°C | 16-Lead Lead Frame Chip Scale Package [LFCSP] | CP-16-19 |
| AD8224HACPZ-RL | –40°C to +85°C | 16-Lead Lead Frame Chip Scale Package [LFCSP] | CP-16-19 |
| AD8224HACPZ-WP | –40°C to +85°C | 16-Lead Lead Frame Chip Scale Package [LFCSP] | CP-16-19 |
| AD8224HBCPZ-R7 | –40°C to +85°C | 16-Lead Lead Frame Chip Scale Package [LFCSP] | CP-16-19 |
| AD8224HBCPZ-RL | –40°C to +85°C | 16-Lead Lead Frame Chip Scale Package [LFCSP] | CP-16-19 |
| AD8224HBCPZ-WP | –40°C to +85°C | 16-Lead Lead Frame Chip Scale Package [LFCSP] | CP-16-19 |
| AD8224-EVALZ | | Evaluation Board | |

¹ Z = RoHS Compliant Part.