

IGBT

TRENCHSTOP™ 5 high Speed soft switching IGBT with full current rated RAPID 1 diode

IKW40N65ES5

650V TRENCHSTOP™ 5 high speed soft switching duopak

Data sheet

TRENCHSTOP™ 5 high speed soft switching IGBT copacked with full current rated RAPID 1 fast and soft antiparallel diode

Features and Benefits:

High speed S5 technology offering

- High speed smooth switching device for hard & soft switching
- Very Low V_{CEsat} , 1.35V at nominal current
- Plug and play replacement of previous generation IGBTs
- 650V breakdown voltage
- Low gate charge Q_G
- IGBT copacked with full rated RAPID 1 fast antiparallel diode
- Maximum junction temperature 175°C
- Qualified according to JEDEC for target applications
- Pb-free lead plating; RoHS compliant
- Complete product spectrum and PSpice Models:
<http://www.infineon.com/igbt/>

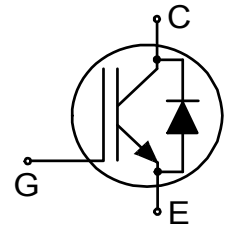

Applications:

- Resonant converters
- Uninterruptible power supplies
- Welding converters
- Mid to high range switching frequency converters

Package pin definition:

- Pin 1 - gate
- Pin 2 & backside - collector
- Pin 3 - emitter



Key Performance and Package Parameters

Type	V_{CE}	I_C	$V_{CEsat}, T_{vj}=25^{\circ}C$	T_{vjmax}	Marking	Package
IKW40N65ES5	650V	40A	1.35V	175°C	K40EES5	PG-TO247-3

Table of Contents

Description	2
Table of Contents	3
Maximum Ratings	4
Thermal Resistance	4
Electrical Characteristics	5
Electrical Characteristics Diagrams	8
Package Drawing	14
Testing Conditions	15
Revision History	16
Disclaimer	16

Maximum Ratings

For optimum lifetime and reliability, Infineon recommends operating conditions that do not exceed 80% of the maximum ratings stated in this datasheet.

Parameter	Symbol	Value	Unit
Collector-emitter voltage, $T_{vj} \geq 25^{\circ}\text{C}$	V_{CE}	650	V
DC collector current, limited by T_{vjmax} $T_C = 25^{\circ}\text{C}$ $T_C = 100^{\circ}\text{C}$	I_C	79.0 50.0	A
Pulsed collector current, t_p limited by T_{vjmax}	I_{Cpuls}	160.0	A
Turn off safe operating area $V_{CE} \leq 650\text{V}$, $T_{vj} \leq 175^{\circ}\text{C}$, $t_p = 1\mu\text{s}$	-	160.0	A
Diode forward current, limited by T_{vjmax} $T_C = 25^{\circ}\text{C}$ $T_C = 100^{\circ}\text{C}$	I_F	79.0 50.0	A
Diode pulsed current, t_p limited by T_{vjmax}	I_{Fpuls}	160.0	A
Gate-emitter voltage Transient Gate-emitter voltage ($t_p \leq 10\mu\text{s}$, $D < 0.010$)	V_{GE}	± 20 ± 30	V
Power dissipation $T_C = 25^{\circ}\text{C}$ Power dissipation $T_C = 100^{\circ}\text{C}$	P_{tot}	230.0 115.0	W
Operating junction temperature	T_{vj}	-40...+175	$^{\circ}\text{C}$
Storage temperature	T_{stg}	-55...+150	$^{\circ}\text{C}$
Soldering temperature, wave soldering 1.6mm (0.063in.) from case for 10s		260	$^{\circ}\text{C}$
Mounting torque, M3 screw Maximum of mounting processes: 3	M	0.6	Nm

Thermal Resistance

Parameter	Symbol	Conditions	Max. Value	Unit
Characteristic				
IGBT thermal resistance, junction - case	$R_{th(j-c)}$		0.65	K/W
Diode thermal resistance, junction - case	$R_{th(j-c)}$		0.75	K/W
Thermal resistance junction - ambient	$R_{th(j-a)}$		40	K/W

Electrical Characteristic, at $T_{vj} = 25^{\circ}\text{C}$, unless otherwise specified

Parameter	Symbol	Conditions	Value			Unit
			min.	typ.	max.	
Static Characteristic						
Collector-emitter breakdown voltage	$V_{(BR)CES}$	$V_{GE} = 0\text{V}, I_C = 0.20\text{mA}$	650	-	-	V
Collector-emitter saturation voltage	V_{CEsat}	$V_{GE} = 15.0\text{V}, I_C = 40.0\text{A}$ $T_{vj} = 25^{\circ}\text{C}$ $T_{vj} = 125^{\circ}\text{C}$ $T_{vj} = 175^{\circ}\text{C}$	- - -	1.35 1.50 1.60	1.70 - -	V
Diode forward voltage	V_F	$V_{GE} = 0\text{V}, I_F = 40.0\text{A}$ $T_{vj} = 25^{\circ}\text{C}$ $T_{vj} = 125^{\circ}\text{C}$ $T_{vj} = 175^{\circ}\text{C}$	- - -	1.45 1.42 1.39	1.70 - -	V
Gate-emitter threshold voltage	$V_{GE(th)}$	$I_C = 0.40\text{mA}, V_{CE} = V_{GE}$	3.2	4.0	4.8	V
Zero gate voltage collector current	I_{CES}	$V_{CE} = 650\text{V}, V_{GE} = 0\text{V}$ $T_{vj} = 25^{\circ}\text{C}$ $T_{vj} = 175^{\circ}\text{C}$	- -	- 1700	50 -	μA
Gate-emitter leakage current	I_{GES}	$V_{CE} = 0\text{V}, V_{GE} = 20\text{V}$	-	-	100	nA
Transconductance	g_{fs}	$V_{CE} = 20\text{V}, I_C = 40.0\text{A}$	-	45.0	-	S

Electrical Characteristic, at $T_{vj} = 25^{\circ}\text{C}$, unless otherwise specified

Parameter	Symbol	Conditions	Value			Unit
			min.	typ.	max.	
Dynamic Characteristic						
Input capacitance	C_{ies}	$V_{CE} = 25\text{V}, V_{GE} = 0\text{V}, f = 1\text{MHz}$	-	2500	-	pF
Output capacitance	C_{oes}		-	71	-	
Reverse transfer capacitance	C_{res}		-	9	-	
Gate charge	Q_G	$V_{CC} = 520\text{V}, I_C = 40.0\text{A},$ $V_{GE} = 15\text{V}$	-	95.0	-	nC
Internal emitter inductance measured 5mm (0.197 in.) from case	L_E		-	13.0	-	nH

Switching Characteristic, Inductive Load

Parameter	Symbol	Conditions	Value			Unit
			min.	typ.	max.	

IGBT Characteristic, at $T_{vj} = 25^{\circ}\text{C}$

Turn-on delay time	$t_{d(on)}$	$T_{vj} = 25^{\circ}\text{C},$ $V_{CC} = 400\text{V}, I_C = 40.0\text{A},$ $V_{GE} = 0.0/15.0\text{V},$ $R_{G(on)} = 10.0\Omega, R_{G(off)} = 10.0\Omega,$ $L_{\sigma} = 30\text{nH}, C_{\sigma} = 30\text{pF}$ L_{σ}, C_{σ} from Fig. E Energy losses include "tail" and diode reverse recovery.	-	19	-	ns
Rise time	t_r		-	18	-	ns
Turn-off delay time	$t_{d(off)}$		-	130	-	ns
Fall time	t_f		-	23	-	ns
Turn-on energy	E_{on}		-	0.86	-	mJ
Turn-off energy	E_{off}		-	0.40	-	mJ
Total switching energy	E_{ts}		-	1.26	-	mJ

TRENCHSTOP™ 5 soft switching IGBT

Turn-on delay time	$t_{d(on)}$	$T_{vj} = 25^{\circ}\text{C}$, $V_{CC} = 400\text{V}$, $I_C = 20.0\text{A}$, $V_{GE} = 0.0/15.0\text{V}$, $R_{G(on)} = 10.0\Omega$, $R_{G(off)} = 10.0\Omega$, $L\sigma = 30\text{nH}$, $C\sigma = 30\text{pF}$ $L\sigma$, $C\sigma$ from Fig. E Energy losses include "tail" and diode reverse recovery.	-	18	-	ns
Rise time	t_r		-	7	-	ns
Turn-off delay time	$t_{d(off)}$		-	143	-	ns
Fall time	t_f		-	24	-	ns
Turn-on energy	E_{on}		-	0.39	-	mJ
Turn-off energy	E_{off}		-	0.21	-	mJ
Total switching energy	E_{ts}		-	0.60	-	mJ

Diode Characteristic, at $T_{vj} = 25^{\circ}\text{C}$

Diode reverse recovery time	t_{rr}	$T_{vj} = 25^{\circ}\text{C}$, $V_R = 400\text{V}$, $I_F = 40.0\text{A}$, $di_F/dt = 820\text{A}/\mu\text{s}$	-	73	-	ns
Diode reverse recovery charge	Q_{rr}		-	1.10	-	μC
Diode peak reverse recovery current	I_{rrm}		-	23.0	-	A
Diode peak rate of fall of reverse recovery current during t_b	di_{rr}/dt		-	-1500	-	$\text{A}/\mu\text{s}$
Diode reverse recovery time	t_{rr}	$T_{vj} = 25^{\circ}\text{C}$, $V_R = 400\text{V}$, $I_F = 20.0\text{A}$, $di_F/dt = 750\text{A}/\mu\text{s}$	-	58	-	ns
Diode reverse recovery charge	Q_{rr}		-	0.80	-	μC
Diode peak reverse recovery current	I_{rrm}		-	22.0	-	A
Diode peak rate of fall of reverse recovery current during t_b	di_{rr}/dt		-	-1740	-	$\text{A}/\mu\text{s}$

Switching Characteristic, Inductive Load

Parameter	Symbol	Conditions	Value			Unit
			min.	typ.	max.	

IGBT Characteristic, at $T_{vj} = 150^{\circ}\text{C}$

Turn-on delay time	$t_{d(on)}$	$T_{vj} = 150^{\circ}\text{C}$, $V_{CC} = 400\text{V}$, $I_C = 40.0\text{A}$, $V_{GE} = 0.0/15.0\text{V}$, $R_{G(on)} = 10.0\Omega$, $R_{G(off)} = 10.0\Omega$, $L\sigma = 30\text{nH}$, $C\sigma = 30\text{pF}$ $L\sigma$, $C\sigma$ from Fig. E Energy losses include "tail" and diode reverse recovery.	-	20	-	ns
Rise time	t_r		-	16	-	ns
Turn-off delay time	$t_{d(off)}$		-	156	-	ns
Fall time	t_f		-	48	-	ns
Turn-on energy	E_{on}		-	1.20	-	mJ
Turn-off energy	E_{off}		-	0.69	-	mJ
Total switching energy	E_{ts}		-	1.89	-	mJ
Turn-on delay time	$t_{d(on)}$	$T_{vj} = 150^{\circ}\text{C}$, $V_{CC} = 400\text{V}$, $I_C = 20.0\text{A}$, $V_{GE} = 0.0/15.0\text{V}$, $R_{G(on)} = 10.0\Omega$, $R_{G(off)} = 10.0\Omega$, $L\sigma = 30\text{nH}$, $C\sigma = 30\text{pF}$ $L\sigma$, $C\sigma$ from Fig. E Energy losses include "tail" and diode reverse recovery.	-	18	-	ns
Rise time	t_r		-	8	-	ns
Turn-off delay time	$t_{d(off)}$		-	184	-	ns
Fall time	t_f		-	48	-	ns
Turn-on energy	E_{on}		-	0.60	-	mJ
Turn-off energy	E_{off}		-	0.39	-	mJ
Total switching energy	E_{ts}		-	0.99	-	mJ

Diode Characteristic, at $T_{vj} = 150^{\circ}\text{C}$

Diode reverse recovery time	t_{rr}	$T_{vj} = 150^{\circ}\text{C},$ $V_R = 400\text{V},$ $I_F = 40.0\text{A},$ $di_F/dt = 820\text{A}/\mu\text{s}$	-	120	-	ns
Diode reverse recovery charge	Q_{rr}		-	2.60	-	μC
Diode peak reverse recovery current	I_{rrm}		-	36.0	-	A
Diode peak rate of fall of reverse recovery current during t_b	di_{rr}/dt		-	-1250	-	$\text{A}/\mu\text{s}$
Diode reverse recovery time	t_{rr}	$T_{vj} = 150^{\circ}\text{C},$ $V_R = 400\text{V},$ $I_F = 20.0\text{A},$ $di_F/dt = 750\text{A}/\mu\text{s}$	-	91	-	ns
Diode reverse recovery charge	Q_{rr}		-	1.80	-	μC
Diode peak reverse recovery current	I_{rrm}		-	32.0	-	A
Diode peak rate of fall of reverse recovery current during t_b	di_{rr}/dt		-	-1350	-	$\text{A}/\mu\text{s}$

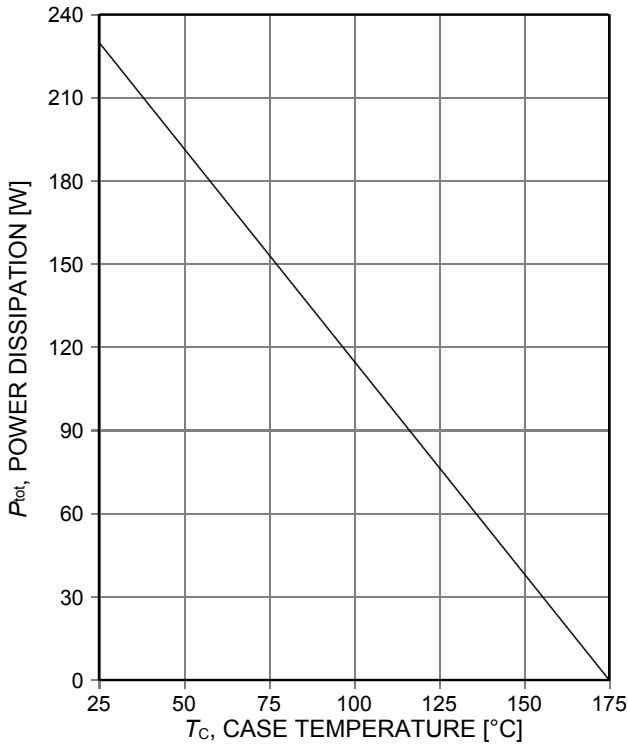

Figure 1. Power dissipation as a function of case temperature ($T_{vj} \leq 175^\circ\text{C}$)

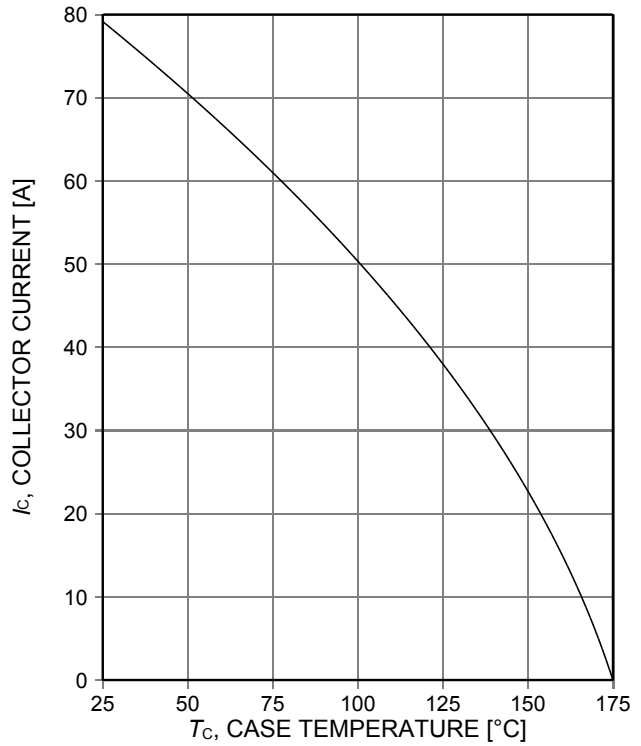

Figure 2. Collector current as a function of case temperature ($V_{GE} \geq 15\text{V}$, $T_{vj} \leq 175^\circ\text{C}$)

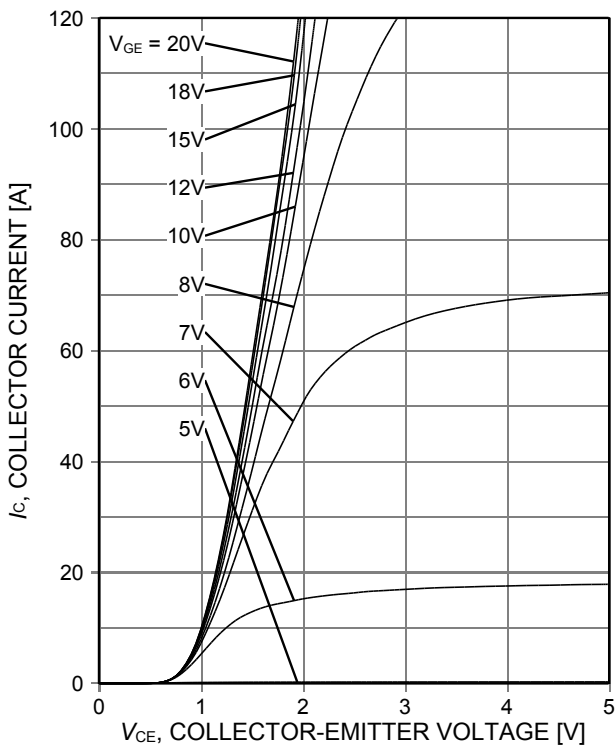

Figure 3. Typical output characteristic ($T_{vj} = 25^\circ\text{C}$)

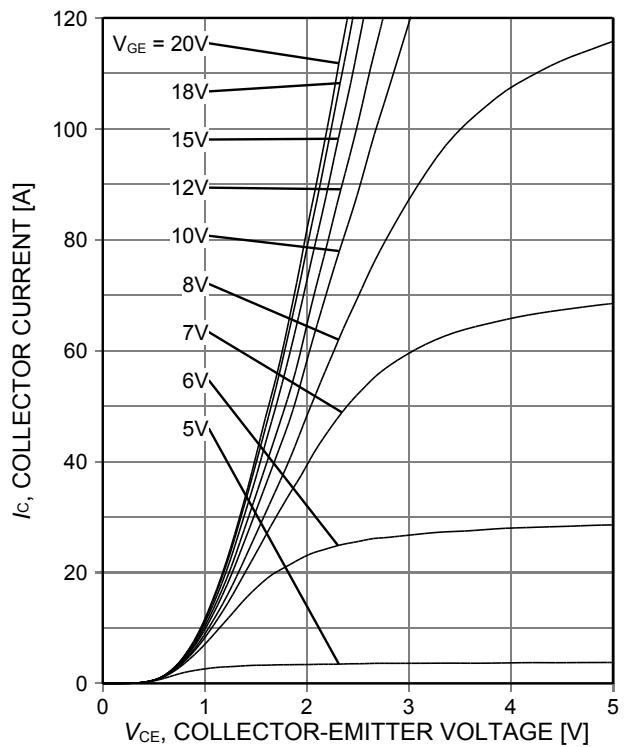

Figure 4. Typical output characteristic ($T_{vj} = 175^\circ\text{C}$)

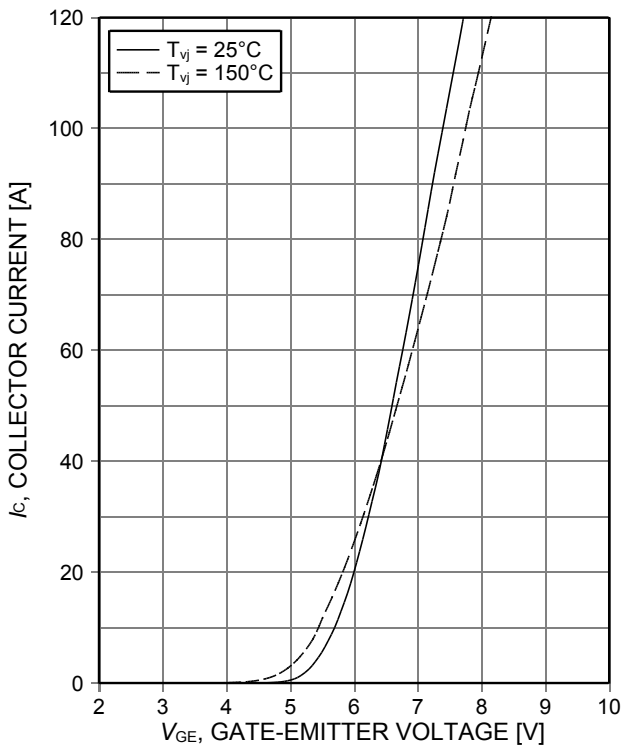

Figure 5. **Typical transfer characteristic**
($V_{CE}=20V$)

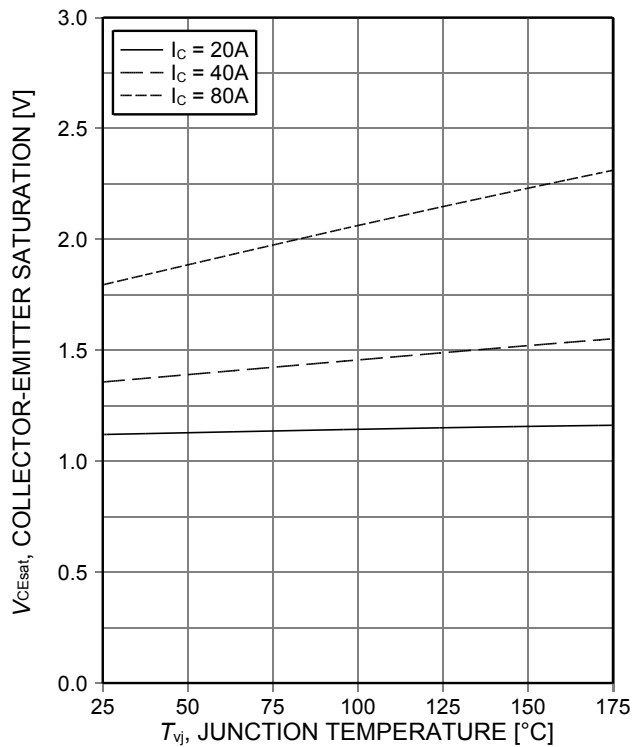

Figure 6. **Typical collector-emitter saturation voltage as a function of junction temperature**
($V_{GE}=15V$)

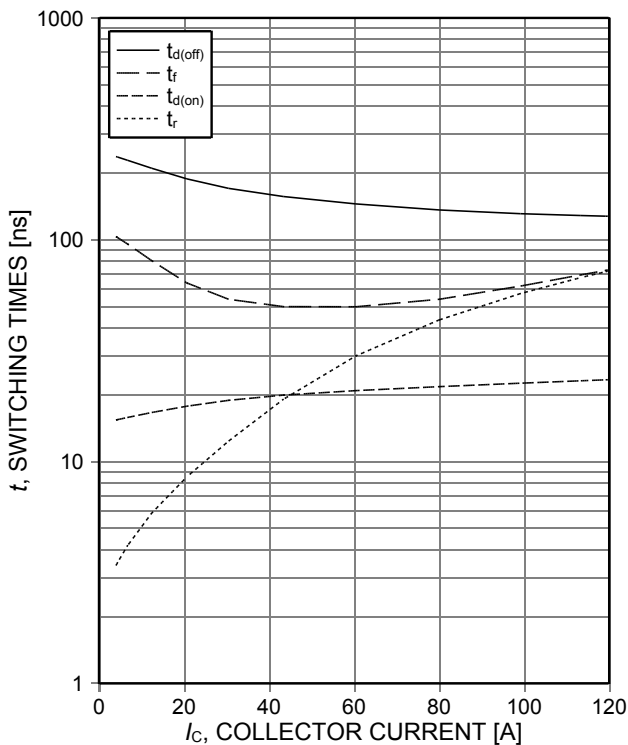

Figure 7. **Typical switching times as a function of collector current**
(inductive load, $T_{vj}=150^{\circ}C$, $V_{CE}=400V$, $V_{GE}=0/15V$, $R_{Gon}=10\Omega$, $R_{Goff}=10\Omega$, dynamic test circuit in Figure E)

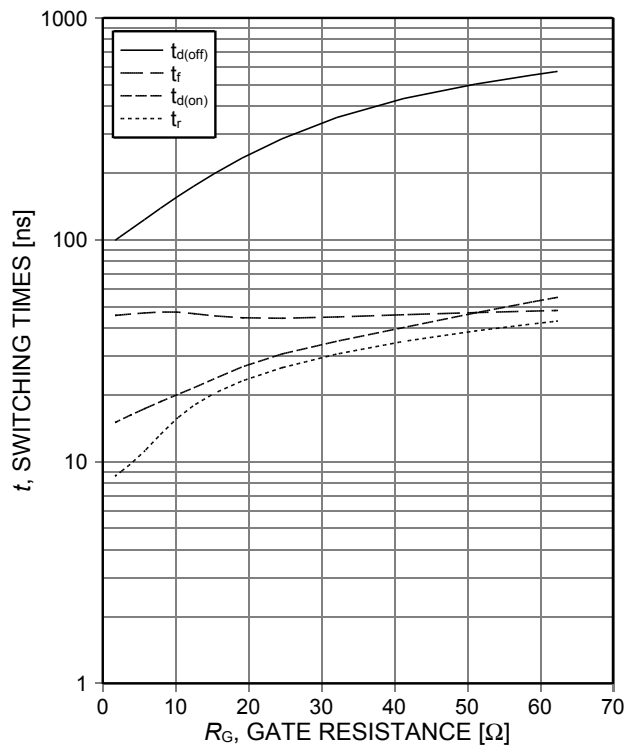

Figure 8. **Typical switching times as a function of gate resistance**
(inductive load, $T_{vj}=150^{\circ}C$, $V_{CE}=400V$, $V_{GE}=0/15V$, $I_C=40A$, dynamic test circuit in Figure E)

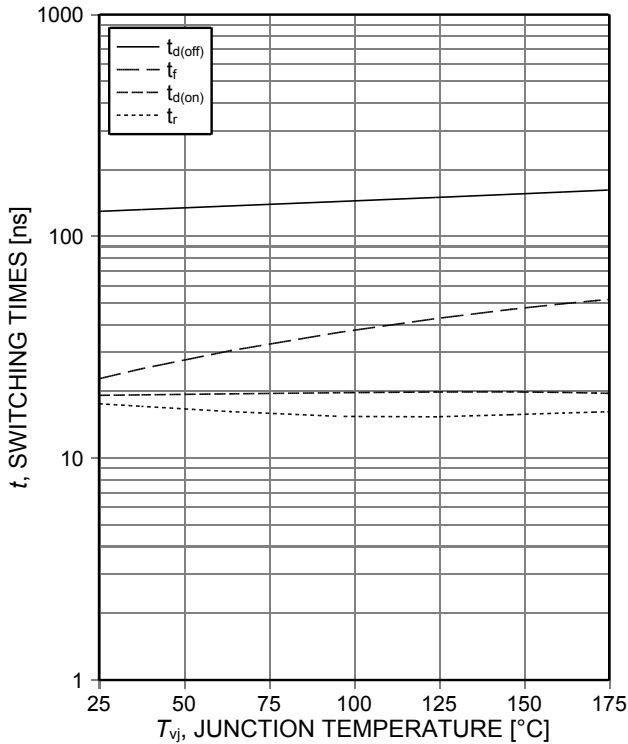

Figure 9. **Typical switching times as a function of junction temperature**
 (inductive load, $V_{CE}=400V$, $V_{GE}=0/15V$, $I_C=40A$, $R_{Gon}=10\Omega$, $R_{Goff}=10\Omega$, dynamic test circuit in Figure E)

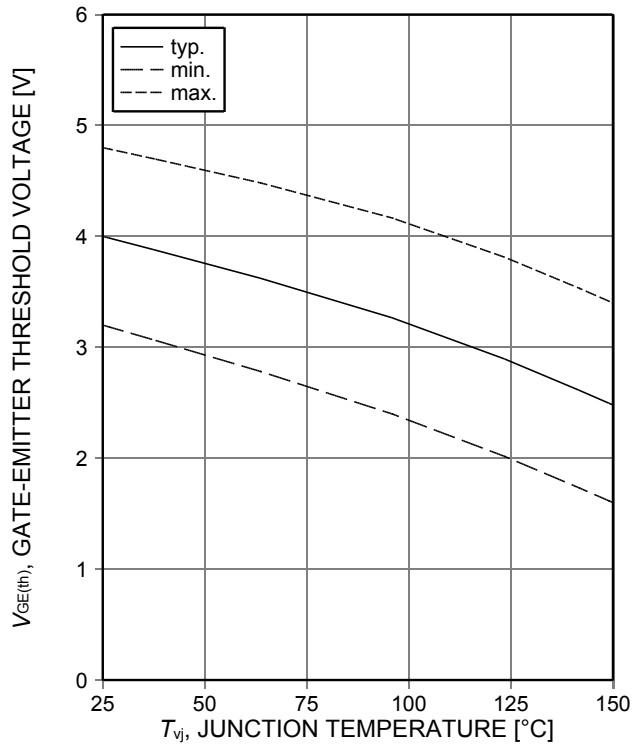

Figure 10. **Gate-emitter threshold voltage as a function of junction temperature**
 ($I_C=0.4mA$)

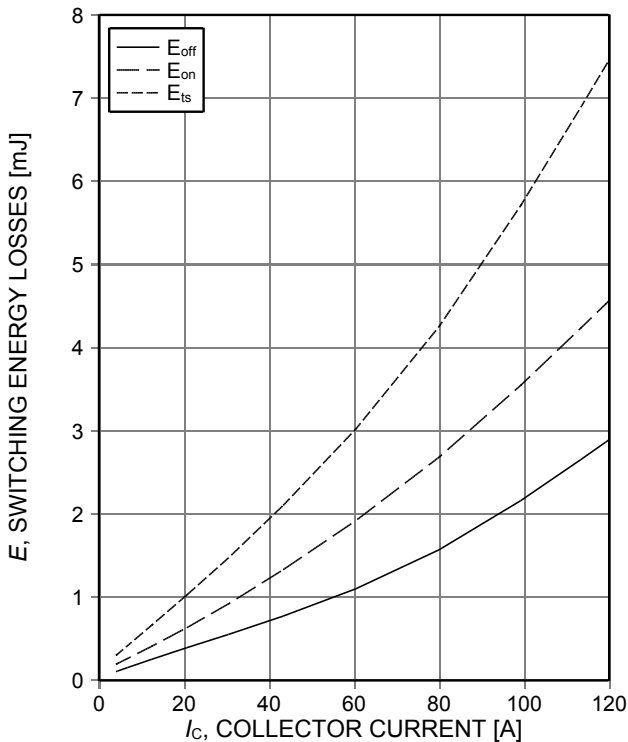

Figure 11. **Typical switching energy losses as a function of collector current**
 (inductive load, $T_{vj}=150^\circ C$, $V_{CE}=400V$, $V_{GE}=0/15V$, $R_{Gon}=10\Omega$, $R_{Goff}=10\Omega$, dynamic test circuit in Figure E)

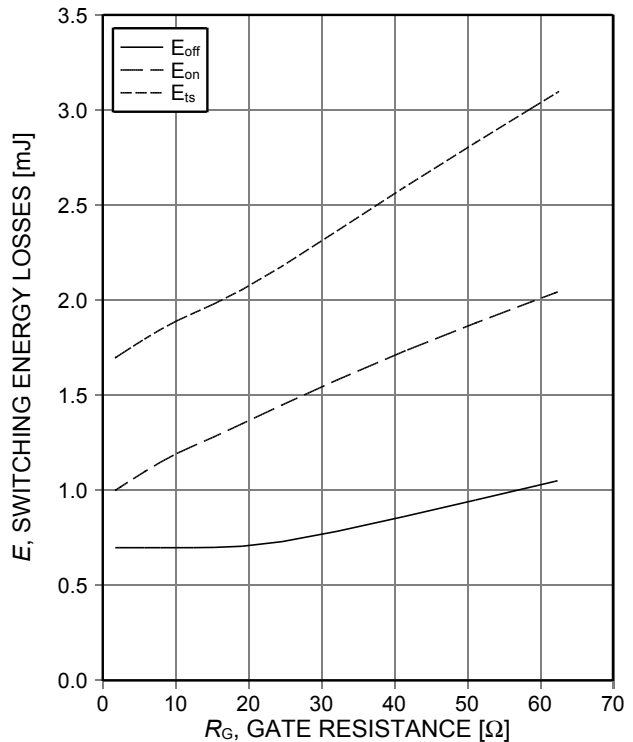

Figure 12. **Typical switching energy losses as a function of gate resistance**
 (inductive load, $T_{vj}=150^\circ C$, $V_{CE}=400V$, $V_{GE}=0/15V$, $I_C=40A$, dynamic test circuit in Figure E)

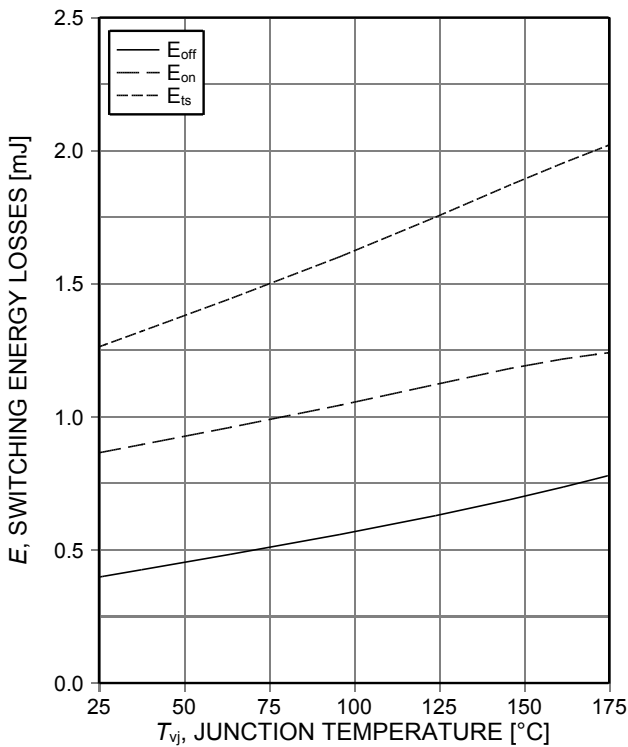

Figure 13. Typical switching energy losses as a function of junction temperature (inductive load, $V_{CE}=400V$, $V_{GE}=0/15V$, $I_C=40A$, $R_{Gon}=10\Omega$, $R_{Goff}=10\Omega$, dynamic test circuit in Figure E)

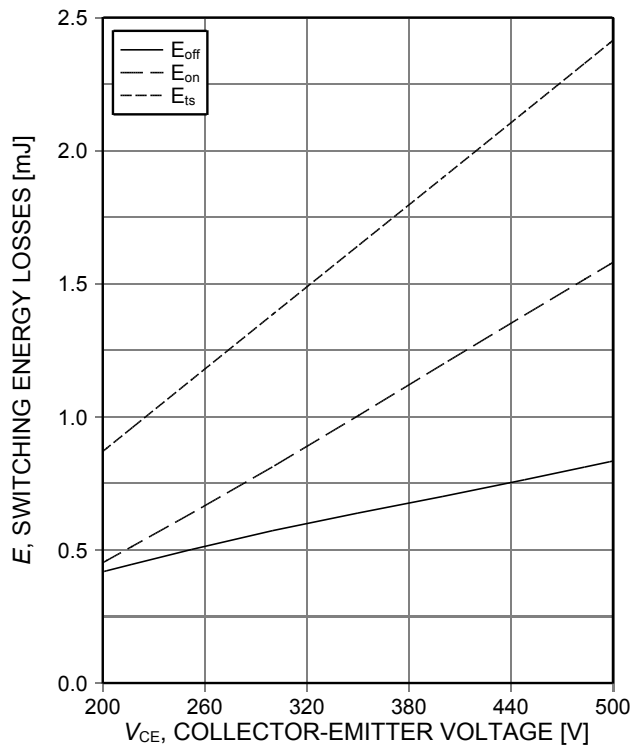

Figure 14. Typical switching energy losses as a function of collector-emitter voltage (inductive load, $T_{vj}=150^\circ C$, $V_{GE}=0/15V$, $I_C=40A$, $R_{Gon}=10\Omega$, $R_{Goff}=10\Omega$, dynamic test circuit in Figure E)

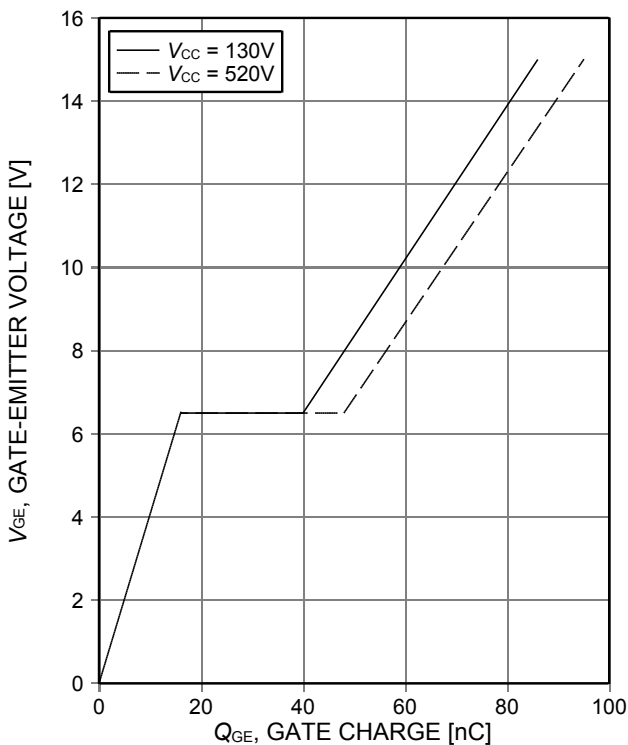

Figure 15. Typical gate charge ($I_C=40A$)

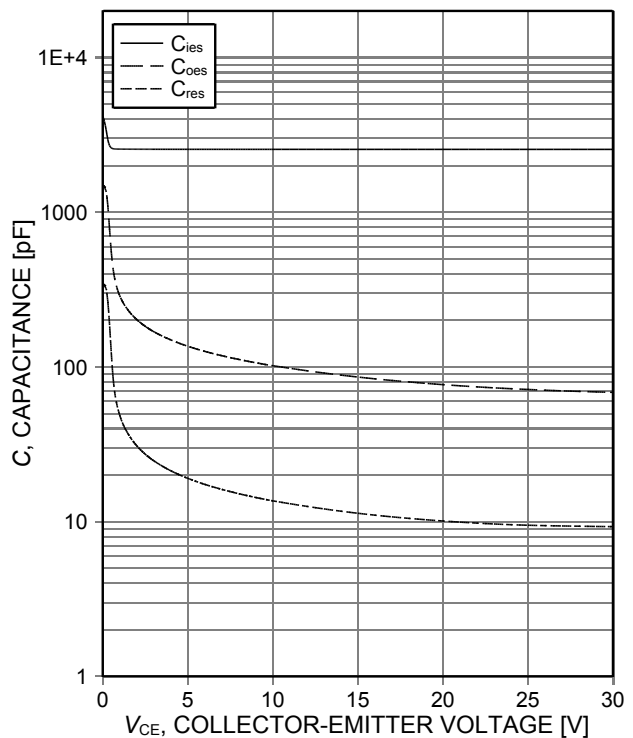

Figure 16. Typical capacitance as a function of collector-emitter voltage ($V_{GE}=0V$, $f=1MHz$)

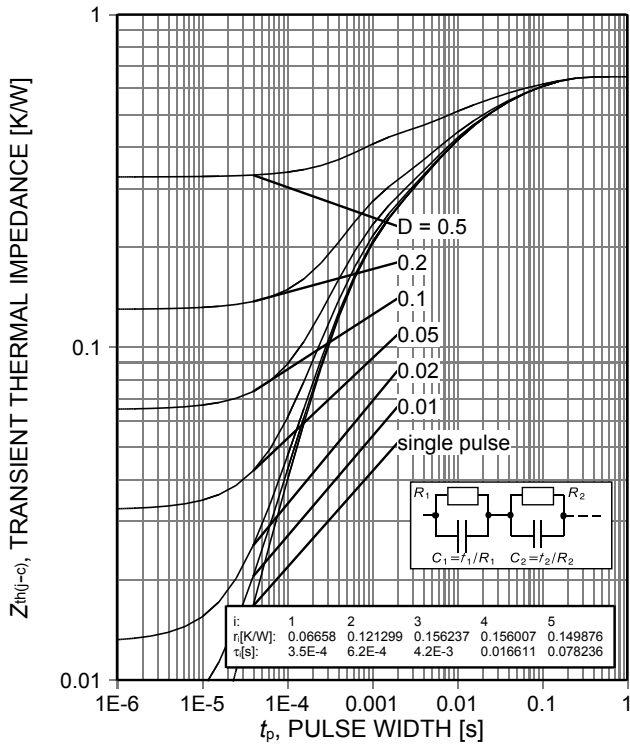

Figure 17. IGBT transient thermal impedance (D=t_p/T)

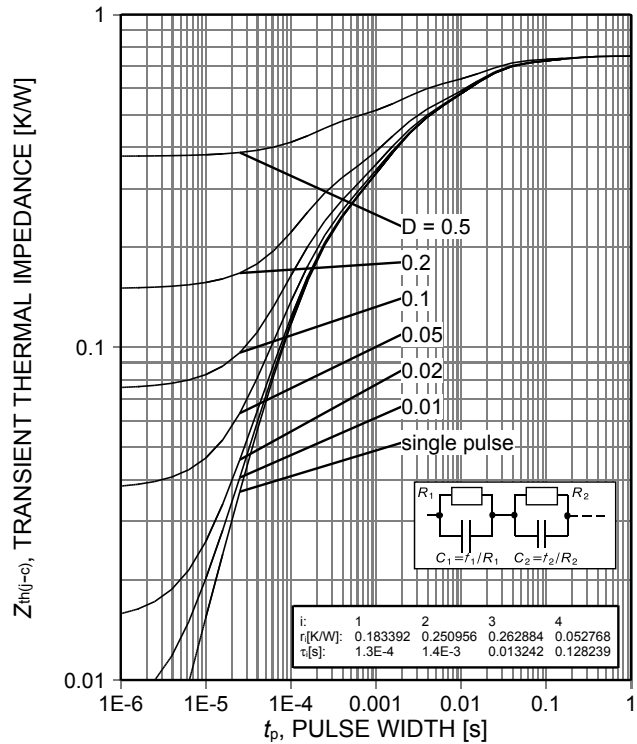

Figure 18. Diode transient thermal impedance as a function of pulse width (D=t_p/T)

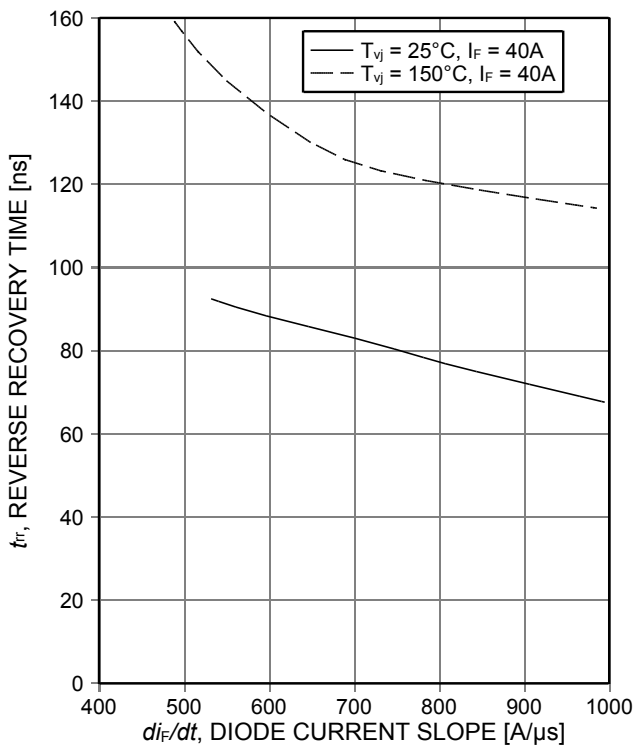

Figure 19. Typical reverse recovery time as a function of diode current slope (V_R=400V)

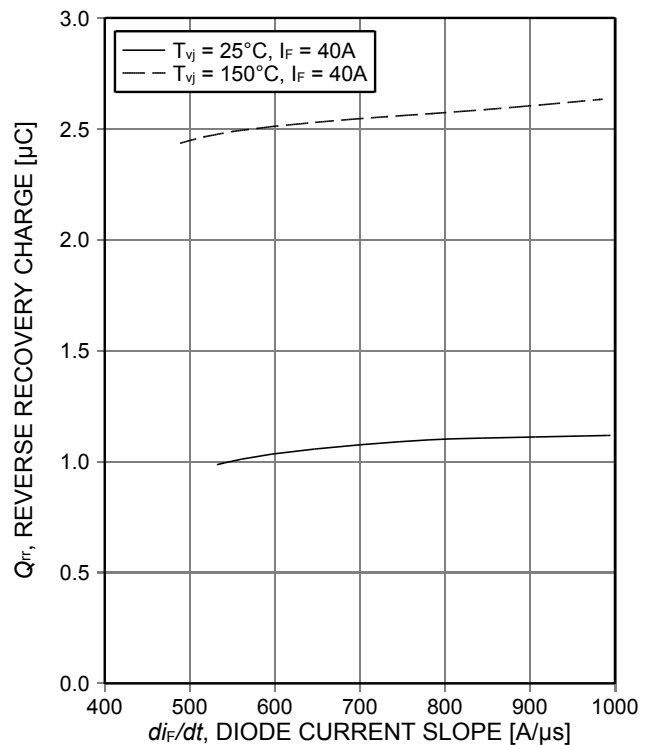

Figure 20. Typical reverse recovery charge as a function of diode current slope (V_R=400V)

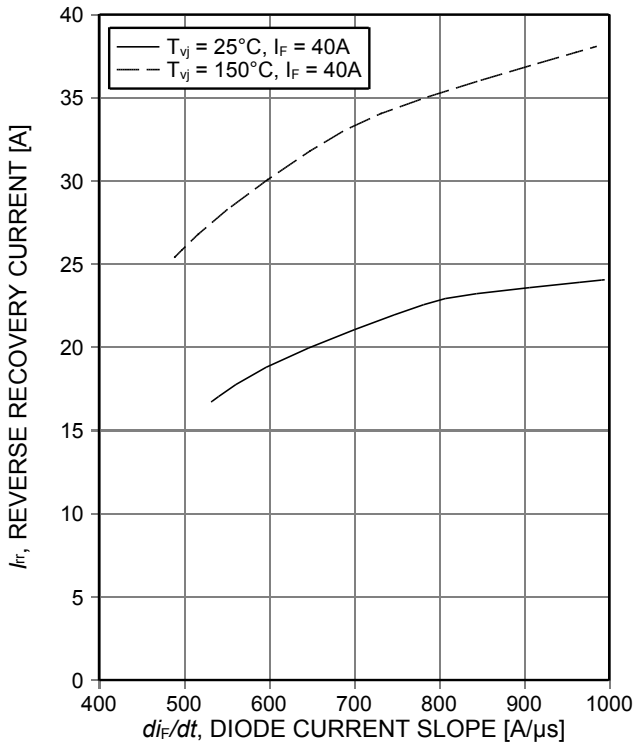

Figure 21. Typical reverse recovery current as a function of diode current slope (VR=400V)

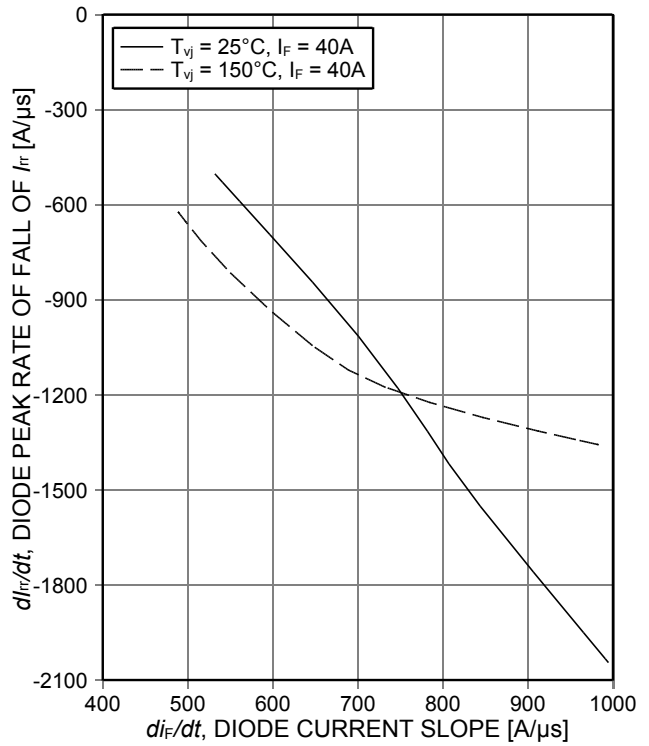

Figure 22. Typical diode peak rate of fall of reverse recovery current as a function of diode current slope (VR=400V)

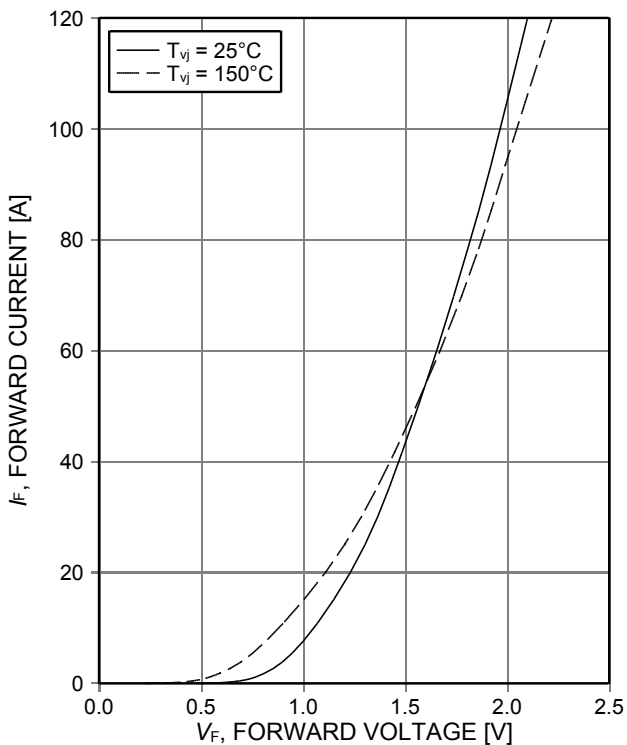

Figure 23. Typical diode forward current as a function of forward voltage

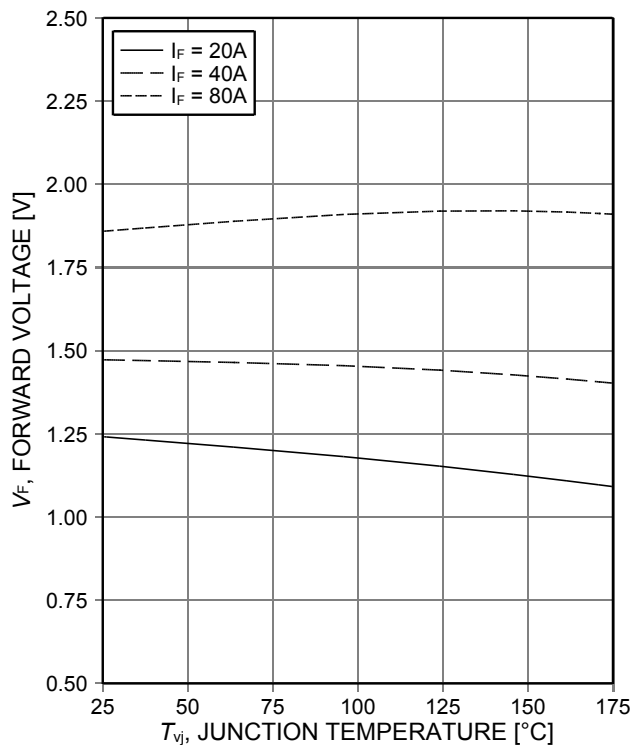
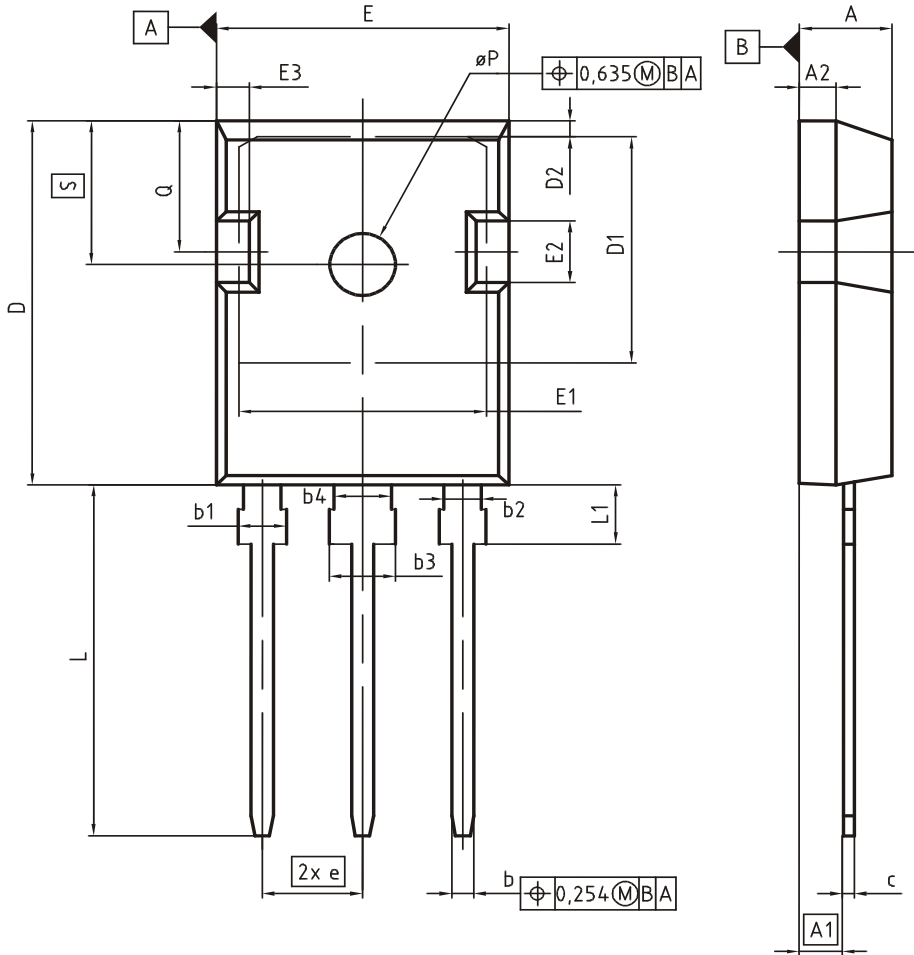

Figure 24. Typical diode forward voltage as a function of junction temperature

Package Drawing PG-TO247-3



DIM	MILLIMETERS		INCHES	
	MIN	MAX	MIN	MAX
A	4.83	5.21	0.190	0.205
A1	2.27	2.54	0.089	0.100
A2	1.85	2.16	0.073	0.085
b	1.07	1.33	0.042	0.052
b1	1.90	2.41	0.075	0.095
b2	1.90	2.16	0.075	0.085
b3	2.87	3.38	0.113	0.133
b4	2.87	3.13	0.113	0.123
c	0.55	0.68	0.022	0.027
D	20.80	21.10	0.819	0.831
D1	16.25	17.65	0.640	0.695
D2	0.95	1.35	0.037	0.053
E	15.70	16.13	0.618	0.635
E1	13.10	14.15	0.516	0.557
E2	3.68	5.10	0.145	0.201
E3	1.00	2.60	0.039	0.102
e	5.44 (BSC)		0.214 (BSC)	
N	3		3	
L	19.80	20.32	0.780	0.800
L1	4.10	4.47	0.161	0.176
øP	3.50	3.70	0.138	0.146
Q	5.49	6.00	0.216	0.236
S	6.04	6.30	0.238	0.248

DOCUMENT NO.
Z8B00003327

SCALE
0 5 5 7.5mm

EUROPEAN PROJECTION

ISSUE DATE
09-07-2010

REVISION
05

Testing Conditions

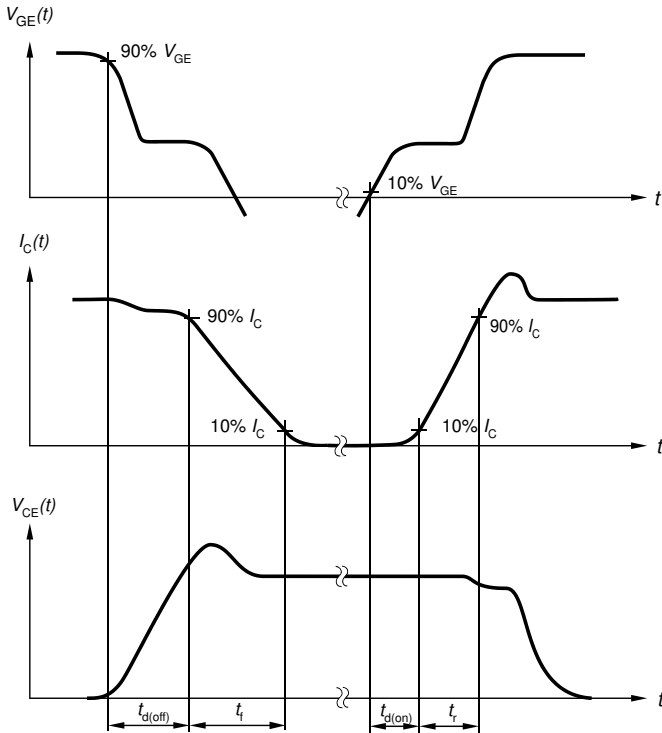

Figure A. Definition of switching times

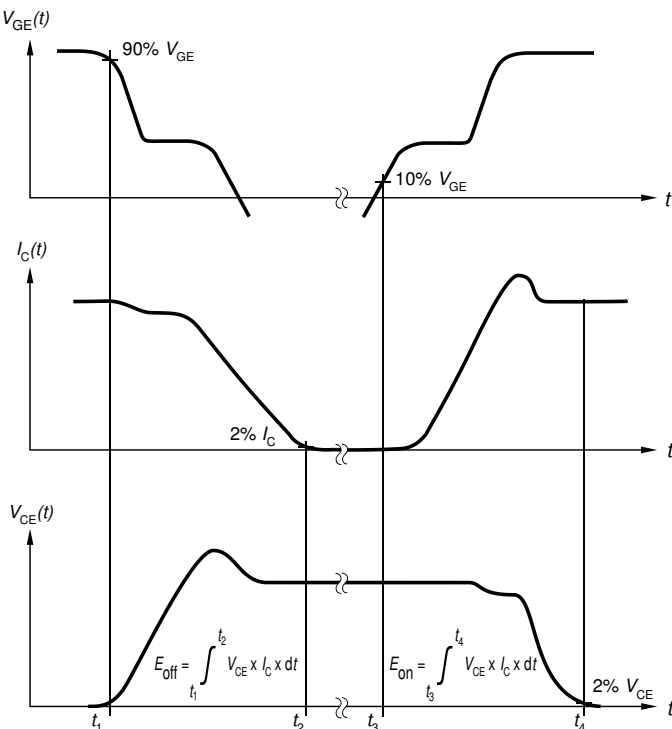

Figure B. Definition of switching losses

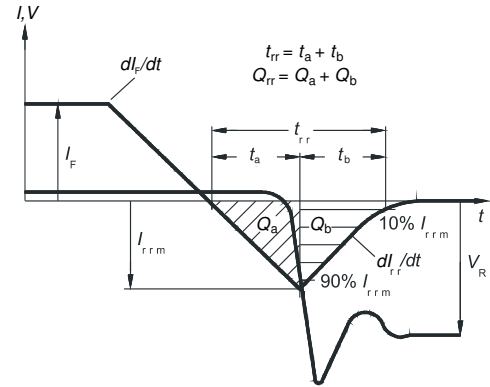

Figure C. Definition of diode switching characteristics

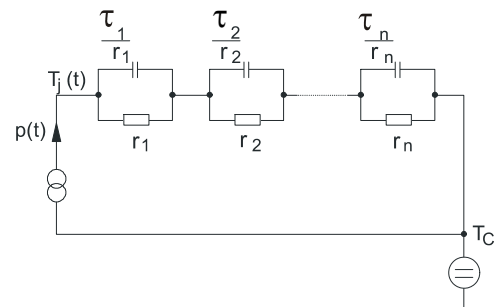

Figure D. Thermal equivalent circuit

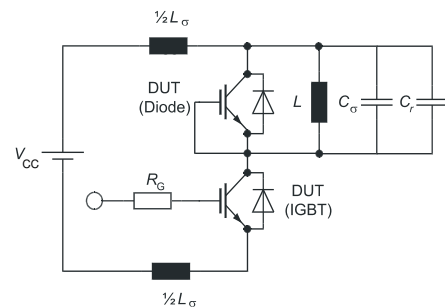

Figure E. Dynamic test circuit
Parasitic inductance L_σ ,
parasitic capacitor C_σ ,
relief capacitor C_r ,
(only for ZVT switching)

Revision History

IKW40N65ES5

Revision: 2015-10-16, Rev. 2.2

Previous Revision

Revision	Date	Subjects (major changes since last revision)
0.1	2015-05-26	Target data sheet
1.1	2015-08-12	Preliminary data sheet
2.1	2015-09-22	Final data sheet
2.2	2015-10-16	Minor change $I_c(VCE)$ Fig. 3 and Fig. 4

Published by
Infineon Technologies AG
81726 München, Germany
© Infineon Technologies AG 2015.
All Rights Reserved.

Important Notice

The information given in this document shall in no event be regarded as a guarantee of conditions or characteristics (“Beschaffenheitsgarantie”). With respect to any examples, hints or any typical values stated herein and/or any information regarding the application of the product, Infineon Technologies hereby disclaims any and all warranties and liabilities of any kind, including without limitation warranties of non-infringement of intellectual property rights of any third party.

In addition, any information given in this document is subject to customer’s compliance with its obligations stated in this document and any applicable legal requirements, norms and standards concerning customer’s products and any use of the product of Infineon Technologies in customer’s applications.

The data contained in this document is exclusively intended for technically trained staff. It is the responsibility of customer’s technical departments to evaluate the suitability of the product for the intended application and the completeness of the product information given in this document with respect to such application.

For further information on the product, technology, delivery terms and conditions and prices please contact your nearest Infineon Technologies office (www.infineon.com).

Please note that this product is not qualified according to the AEC Q100 or AEC Q101 documents of the Automotive Electronics Council.

Warnings

Due to technical requirements products may contain dangerous substances. For information on the types in question please contact your nearest Infineon Technologies office.

Except as otherwise explicitly approved by Infineon Technologies in a written document signed by authorized representatives of Infineon Technologies, Infineon Technologies’ products may not be used in any applications where a failure of the product or any consequences of the use thereof can reasonably be expected to result in personal injury.