



Low-Voltage, Dual SPDT, Audio Clickless Switches with Negative Rail Capability

General Description

The MAX4762–MAX4764/MAX4764A/MAX4765 dual SPDT (single-pole/double-throw) switches feature negative signal capability that allows signals below ground to pass through without distortion. These analog switches operate from a single +1.8V to +5.5V supply and have low 0.6Ω on-resistance, making them ideal for switching audio signals.

The MAX4763/MAX4765 include a comparator that can be used for headphone detection or a mute/send key function. The MAX4764/MAX4764A/MAX4765 have an internal shunt switch to automatically discharge any capacitance at the NO and NC connection points. This reduces click-and-pop sounds that occur when switching audio signals between precharged points.

These SPDT switches are available in space-saving μ MAX®, TDFN, thin QFN, and UCSP™ packages and operate over the -40°C to $+85^{\circ}\text{C}$ extended temperature range.

Applications

Cell Phones
PDAs and Handheld Devices
Notebook Computers
MP3 Players

μ MAX is a registered trademark and UCSP is a trademark of Maxim Integrated Products, Inc.

Pin Configurations/Functional Diagrams/Truth Table

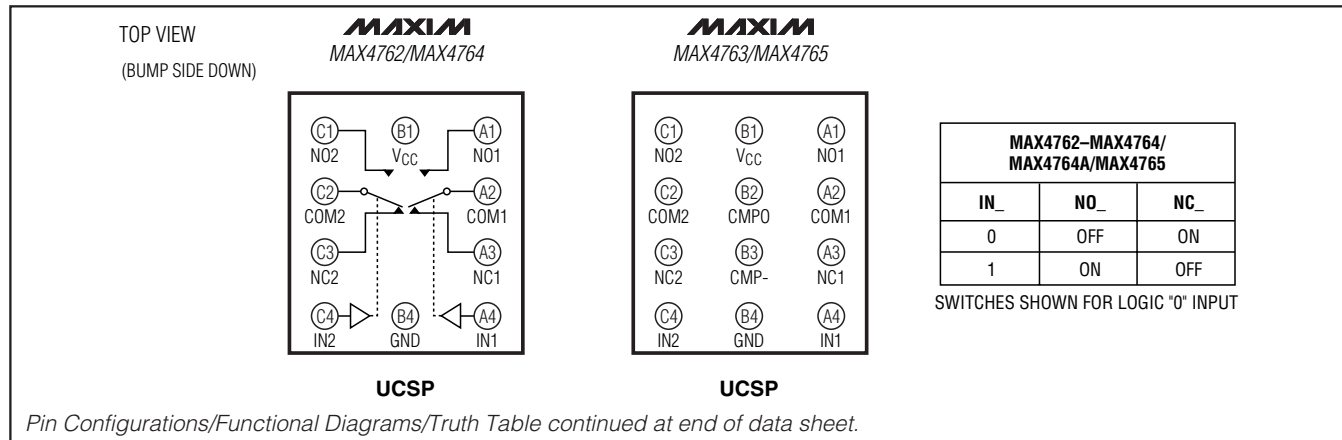

Features

- ◆ Distortion-Free Negative Signal Throughput Down to $V_{CC} - 5.5\text{V}$
- ◆ Comparator for Headphone or Mute Detection (MAX4763/MAX4765)
- ◆ Internal Shunt Resistor Reduces Click/Pop (MAX4764/MAX4764A/MAX4765)
- ◆ Low On-Resistance (R_{ON})
 0.6Ω at +2.7V Supply
- ◆ 0.25Ω On-Resistance Flatness
- ◆ 0.05Ω On-Resistance Matching
- ◆ +1.8V to +5.5V Supply Voltage
- ◆ -70dB Crosstalk (100kHz)
- ◆ -65dB Off-Isolation (100kHz)
- ◆ 0.01% Total Harmonic Distortion
- ◆ Available in μ MAX, TDFN, Thin QFN, and UCSP Packages

Ordering Information

PART	TEMP RANGE	PIN-PACKAGE	TOP MARK
MAX4762ETB	-40°C to $+85^{\circ}\text{C}$	10 TDFN	ACG
MAX4762EUB	-40°C to $+85^{\circ}\text{C}$	10 μ MAX	—
MAX4762EBC-T	-40°C to $+85^{\circ}\text{C}$	12 UCSP-12	ABU

Ordering Information continued at end of data sheet.
Selector Guide appears at end of data sheet.

Low-Voltage, Dual SPDT, Audio Clickless Switches with Negative Rail Capability

ABSOLUTE MAXIMUM RATINGS

(All voltages referenced to GND.)

V _{CC} , I _N _, C _{MP} -	-0.3V to +6.0V
COM_, NO_, NC_	(V _{CC} - 6V) to (V _{CC} + 0.3V)
CMPO	-0.3V to (V _{CC} + 0.3V)
Closed-Switch Continuous Current COM_, NO_, NC_	±150mA
Open-Switch Continuous Current NO_, NC_	
(MAX4764/MAX4764A/MAX4765)	±30mA
Peak Current COM_, NO_, NC_	
(pulsed at 1ms, 50% duty cycle)	±300mA
Peak Current COM_, NO_, NC_	
(pulsed at 1ms, 10% duty cycle)	±400mA
Continuous Power Dissipation (T _A = +70°C)	
10-Pin TDFN (derate 24.4mW/°C above +70°C)	1951mW
10-Pin μMAX (derate 5.6mW/°C above +70°C)	444mW

12-Bump UCSP (MAX4762/MAX4764)	
(derate 5.6mW/°C above +70°C)	449mW
12-Bump UCSP (MAX4763/MAX4765)	
(derate 6.5mW/°C above +70°C)	519mW
12-Pin Thin QFN (derate 16.9mW/°C above +70°C)	1349mW
ESD Method 3015.7	±2kV
Operating Temperature Range	-40°C to +85°C
Junction Temperature	+150°C
Storage Temperature Range	-65°C to +150°C
Lead Temperature (soldering, 10s)	+300°C
Bump Temperature (soldering)	
Infrared (15s)	+220°C
Vapor Phase (60s)	+215°C

Stresses beyond those listed under "Absolute Maximum Ratings" may cause permanent damage to the device. These are stress ratings only, and functional operation of the device at these or any other conditions beyond those indicated in the operational sections of the specifications is not implied. Exposure to absolute maximum rating conditions for extended periods may affect device reliability.

ELECTRICAL CHARACTERISTICS

(V_{CC} = +2.7V to +5.5V, T_A = -40°C to +85°C, unless otherwise noted. Typical values are at V_{CC} = +3.0V, T_A = +25°C, unless otherwise noted.) (Note 1)

PARAMETER	SYMBOL	CONDITIONS	MIN	TYP	MAX	UNITS
ANALOG SWITCH						
Analog Signal Range (Note 2)	V _{NO} _, V _{NC} _, V _{COM} _		V _{CC} - 5.5		V _{CC}	V
On-Resistance (Notes 3 and 4)	R _{ON(NC)} , R _{ON(NO)}	V _{CC} = 2.7V; V _{NC} _ or V _{NO} _ = V _{CC} - 5.5V, -1V, 0V, 1V, 2V, V _{CC} ; I _{COM} _ = 100mA		0.6	0.85	Ω
			T _A = +25°C			
			T _A = T _{MIN} to T _{MAX}		0.95	
On-Resistance Match Between Channels (Notes 3, 4, and 5)	ΔR _{ON}	V _{CC} = 2.7V, V _{NC} _ or V _{NO} _ = 0V, I _{COM} _ = 100mA		0.05	0.1	Ω
			T _A = +25°C			
			T _A = T _{MIN} to T _{MAX}		0.15	
On-Resistance Flatness (Notes 4 and 6)	R _{FLAT(NC)}	V _{CC} = 2.7V; V _{NC} _ or V _{NC} = -1V, 0V, 1V, 2V, V _{CC} ; I _{COM} _ = 100mA		0.25	0.4	Ω
			T _A = +25°C			
			T _A = T _{MIN} to T _{MAX}		0.45	
Shunt Switch Resistance	R _{SH}	MAX4764/MAX4764A/MAX4765 only, I _{NO} _ or I _{NC} _ = 10mA, V _{CC} = 2.7V		25	50	Ω
			T _A = T _{MIN} to T _{MAX}			
NO_, NC_ Off-Leakage Current (Notes 8 and 9)	I _{NO(OFF)} , I _{NC(OFF)}	MAX4762/MAX4763 only (Note 7), V _{CC} = 2.7V, switch open; V _{NC} _ or V _{NO} _ = -2.5V, +2.5V; V _{COM} _ = +2.5V, -2.5V		-2	+2	nA
			T _A = +25°C			
			T _A = T _{MIN} to T _{MAX}	-10	+10	
COM_ On-Leakage Current (Notes 8 and 9)	I _{COM(ON)}	V _{CC} = 2.7V, switch closed; V _{NC} _ or V _{NO} _ = -2.5V, +2.5V, or floating; V _{COM} _ = -2.5V, +2.5V, or floating		-6	+6	nA
			T _A = +25°C			
			T _A = T _{MIN} to T _{MAX}	-50	+50	

Low-Voltage, Dual SPDT, Audio Clickless Switches with Negative Rail Capability

ELECTRICAL CHARACTERISTICS (continued)

($V_{CC} = +2.7V$ to $+5.5V$, $T_A = -40^{\circ}C$ to $+85^{\circ}C$, unless otherwise noted. Typical values are at $V_{CC} = +3.0V$, $T_A = +25^{\circ}C$, unless otherwise noted.) (Note 1)

PARAMETER	SYMBOL	CONDITIONS	MIN	TYP	MAX	UNITS
DYNAMIC CHARACTERISTICS						
Turn-On Time	t_{ON}	$V_{CC} = 2.7V$, $V_{NO} = 1.5V$; for NO_{-} , $V_{IN_{-}} = 0V$ to V_{CC} ; for NC_{-} , $V_{IN_{-}} = V_{CC}$ to $0V$; $R_L = 300\Omega$, $C_L = 35pF$, Figure 2	$T_A = +25^{\circ}C$	25	80	ns
			$T_A = T_{MIN}$ to T_{MAX}		80	
			$T_A = T_{MIN}$ to T_{MAX} (MAX4764A)	225	500	
Turn-Off Time	t_{OFF}	$V_{CC} = 2.7V$, $V_{NC} = 1.5V$; for NO_{-} , $V_{IN_{-}} = V_{CC}$ to $0V$; for NC_{-} , $V_{IN_{-}} = 0V$ to V_{CC} ; $R_L = 300\Omega$, $C_L = 35pF$, Figure 2	$T_A = +25^{\circ}C$	20	70	ns
			$T_A = T_{MIN}$ to T_{MAX}		70	
			$T_A = T_{MIN}$ to T_{MAX} (MAX4764A)	225	500	
Break-Before-Make Time Delay	t_D	$V_{CC} = 2.7V$, $V_{N_{-}} = 1.5V$, for NO_{-} , $V_{IN_{-}} = V_{CC}$ to $0V$; for NC_{-} , $V_{IN_{-}} = 0V$ to V_{CC} ; $R_L = 300\Omega$, $C_L = 35pF$, Figure 3	$T_A = +25^{\circ}C$	1	7	ns
Charge Injection	Q	$V_{COM_{-}} = 0V$, $C_L = 1.0nF$, Figure 4		150		pC
Off-Isolation (Note 10)	V_{ISO}	$f = 100kHz$, $V_{COM_{-}} = 1V_{RMS}$, $R_L = 50\Omega$, $C_L = 5pF$, Figure 5		-65		dB
Crosstalk	V_{CT}	$f = 100kHz$, $V_{COM_{-}} = 1V_{RMS}$, $R_L = 50\Omega$, $C_L = 5pF$, Figure 5		-70		dB
Power-Supply Rejection Ratio	PSRR	$f = 10kHz$, $V_{COM_{-}} = 1V_{RMS}$, $R_L = 50\Omega$, $C_L = 5pF$		60		dB
On-Channel -3dB Bandwidth	BW	Signal = 0dBm, $R_L = 50\Omega$, $C_L = 5pF$, Figure 5		27		MHz
Total Harmonic Distortion	THD	$f = 20Hz$ to $20kHz$, $V_{COM_{-}} = 0.5V_{P-P}$, DC Bias = 0, $R_L = 32\Omega$		0.01		%
NO_{-} , NC_{-} Off-Capacitance	$C_{NO(OFF)}$ $C_{NC(OFF)}$	$f = 1MHz$, $V_{COM_{-}} = 0.5V_{P-P}$, DC Bias = 0, Figure 6		50		pF
COM On-Capacitance	$C_{COM(ON)}$	$f = 1MHz$, $V_{COM_{-}} = 0.5V_{P-P}$, DC Bias = 0, Figure 6		200		pF
DIGITAL I/O (IN₋)						
Input-Logic High Voltage	V_{IH}	$V_{CC} = 2.7V$ to $3.6V$		1.4		V
		$V_{CC} = 4.2V$ to $5.5V$		2.0		
		$V_{CC} = 2.7V$ to $5.5V$ (MAX4764A only)		1.6		
Input-Logic Low Voltage	V_{IL}	$V_{CC} = 2.7V$ to $3.6V$			0.5	V
		$V_{CC} = 4.2V$ to $5.5V$			0.8	
		$V_{CC} = 2.7V$ to $5.5V$ (MAX4764A only)			0.5	
Input Leakage Current	I_{IN}	$V_{IN_{-}} = 0V$ or V_{CC}		-1	+1	μA
COMPARATOR (MAX4763/MAX4765)						
Comparator Threshold				$V_{CC} / 3$		V

MAX4762-MAX4764/MAX4764A/MAX4765

Low-Voltage, Dual SPDT, Audio Clickless Switches with Negative Rail Capability

ELECTRICAL CHARACTERISTICS (continued)

($V_{CC} = +2.7V$ to $+5.5V$, $T_A = -40^\circ C$ to $+85^\circ C$, unless otherwise noted. Typical values are at $V_{CC} = +3.0V$, $T_A = +25^\circ C$, unless otherwise noted.) (Note 1)

PARAMETER	SYMBOL	CONDITIONS	MIN	TYP	MAX	UNITS
Comparator Output High Voltage		$I_{SOURCE} = 1mA$	$V_{CC} - 0.4V$			V
Comparator Output Low Voltage		$I_{SINK} = 1mA$			0.4V	V
Comparator Input Leakage Current		$V_{CMP-} = 0$ to $2.7V$	-100		+100	nA
Comparator Switching Time		$V_{CC} = 2.7V$, $V_{CMP-} = 0V$ to V_{CC} , from 50% of V_{CMP-} to 50% of V_{CMPO}		1	2	μs
POWER SUPPLY						
Power-Supply Range	V_{CC}		1.8		5.5	V
Supply Current	I+	$V_{CC} = 5.5V$, $V_{IN-} = 0V$ or V_{CC}	MAX4763/MAX4765	5	10	μA
			MAX4762/MAX4764/MAX4764A	0.01	1	
		$V_{CC} = 5.5V$, $V_{IN-} = 1.8V$	MAX4764A	5	10	
		$V_{CC} = 4.2V$, $V_{IN-} = 1.8V$ (Note 11)	MAX4764A	2	5	

Note 1: UCSP and TDFN parts are 100% tested at $T_A = +25^\circ C$ only, and guaranteed by design over the specified temperature range. Thin QFN parts are 100% tested at $T_A = +85^\circ C$ only, and guaranteed by design over the specified temperature range.

Note 2: Signals on COM₋, NO₋, or NC₋ exceeding V_{CC} are clamped by internal diodes. Limit forward-diode current to maximum current rating.

Note 3: Thin QFN and UCSP are guaranteed by design; not production tested.

Note 4: I_{COM} for UCSP is 10mA.

Note 5: $\Delta R_{ON} = R_{ON(MAX)} - R_{ON(MIN)}$.

Note 6: Flatness is defined as the difference between the maximum and minimum value of on-resistance as measured over the specified analog signal ranges.

Note 7: MAX4764/MAX4764A/MAX4765 have an internal shunt switch when in off-state, which determines OFF current.

Note 8: Leakage parameters are 100% tested at maximum-rated hot operating temperature and guaranteed by design at $T_A = +25^\circ C$.

Note 9: UCSP parts are guaranteed by design.

Note 10: Off-isolation = $20\log_{10}(V_{COM} / V_{NO})$, V_{COM} = output, V_{NO} = input to off switch.

Note 11: Guaranteed by design, not production tested.

Low-Voltage, Dual SPDT, Audio Clickless Switches with Negative Rail Capability

Typical Operating Characteristics

($V_{CC} = 3.0V$, $T_A = +25^\circ C$, unless otherwise noted.)

MAX4762-MAX4764/MAX4764A/MAX4765

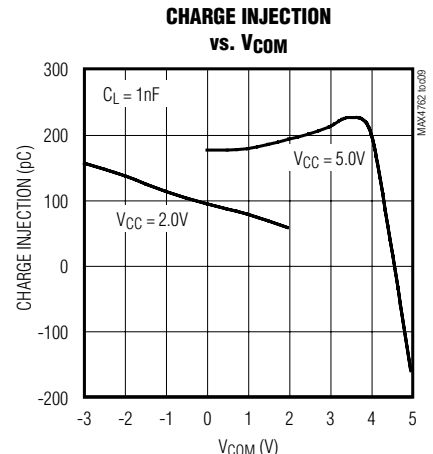
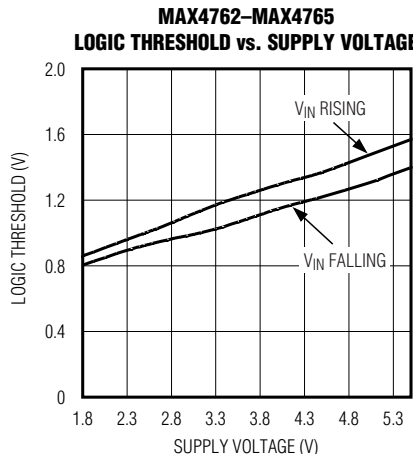
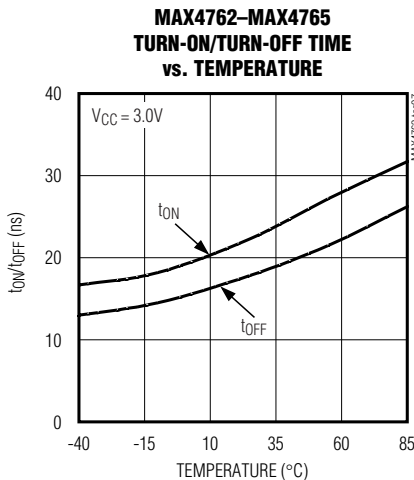
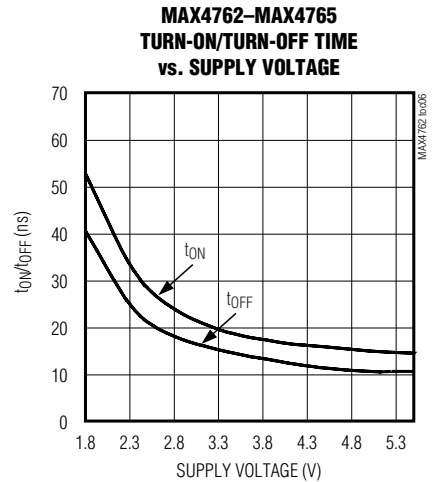
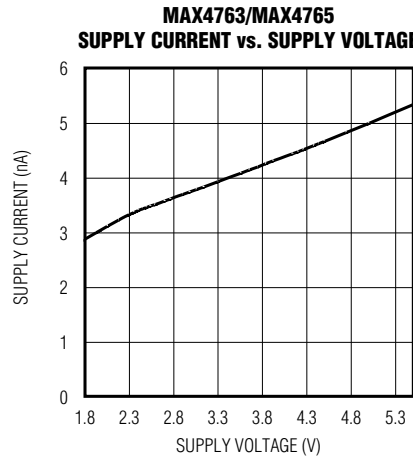
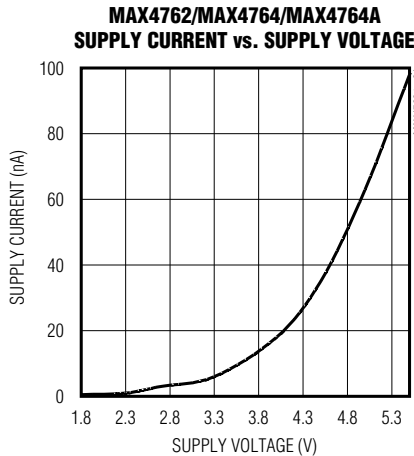
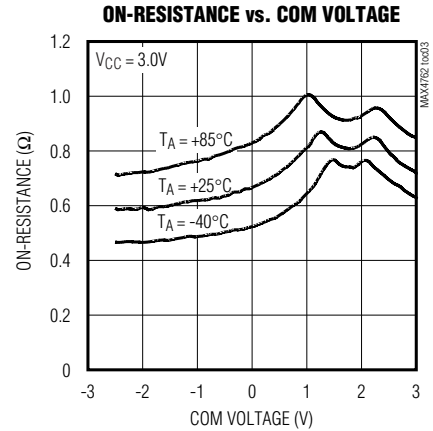

Low-Voltage, Dual SPDT, Audio Clickless Switches with Negative Rail Capability

Typical Operating Characteristics (continued)

($V_{CC} = 3.0V$, $T_A = +25^\circ C$, unless otherwise noted.)

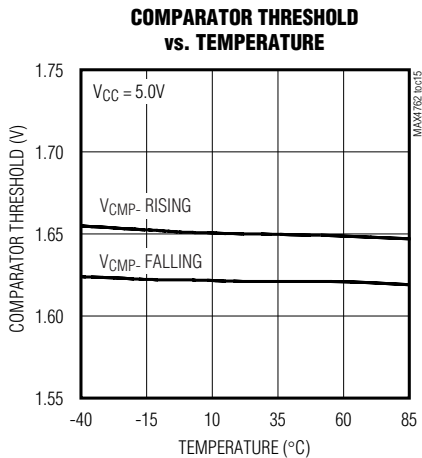
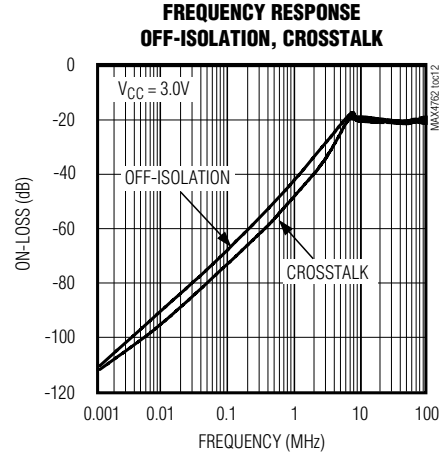

Low-Voltage, Dual SPDT, Audio Clickless Switches with Negative Rail Capability

Pin Description (MAX4762/MAX4764/MAX4764A)

PIN		NAME	FUNCTION
10- μ MAX 10-TDFN	12-UCSP		
1	B1	VCC	Positive-Supply Voltage Input
2	A1	NO1	Analog Switch 1—Normally Open Terminal
3	A2	COM1	Analog Switch 1—Common Terminal
4	A3	NC1	Analog Switch 1—Normally Closed Terminal
5	A4	IN1	Digital Control Input for Analog Switch 1. A logic LOW on IN1 connects COM1 to NC1 and a logic HIGH connects COM1 to NO1.
6	B4	GND	Ground
7	C4	IN2	Digital Control Input for Analog Switch 2. A logic LOW on IN2 connects COM2 to NC2 and a logic HIGH connects COM2 to NO2.
8	C3	NC2	Analog Switch 2—Normally Closed Terminal
9	C2	COM2	Analog Switch 2—Common Terminal
10	C1	NO2	Analog Switch 2—Normally Open Terminal
EP (TDFN only)	—	EP	Exposed pad for TDFN package. Connect to GND.

Pin Description (MAX4763/MAX4765)

PIN		NAME	FUNCTION
12-Thin QFN	12-UCSP		
1	A2	COM1	Analog Switch 1—Common Terminal
2	A3	NC1	Analog Switch 1—Normally Closed Terminal
3	A4	IN1	Digital Control Input for Analog Switch 1. A logic LOW on IN1 connects COM1 to NC1 and a logic HIGH connects COM1 to NO1.
4	B3	CMP-	Comparator Inverting Input
5	B4	GND	Ground
6	C4	IN2	Digital Control Input for Analog Switch 2. A logic LOW on IN2 connects COM2 to NC2 and a logic HIGH connects COM2 to NO2.
7	C3	NC2	Analog Switch 2—Normally Closed Terminal
8	C2	COM2	Analog Switch 2—Common Terminal
9	C1	NO2	Analog Switch 2—Normally Open Terminal
10	B2	CMPO	Comparator Output
11	B1	VCC	Positive-Supply Voltage Input
12	A1	NO1	Analog Switch 1—Normally Open Terminal
EP	—	EP	Exposed pad. Connect to GND.

MAX4762-MAX4764/MAX4764A/MAX4765

Low-Voltage, Dual SPDT, Audio Clickless Switches with Negative Rail Capability



Figure 1. Typical Operating Circuit

Detailed Description

The MAX4762-MAX4764/MAX4764A/MAX4765 are low on-resistance, low-voltage, dual SPDT analog switches that operate from a +1.8V to +5.5V supply and are fully specified for nominal 3.0V applications. The devices feature a negative signal capability that allows signals below ground to pass through without distortion and have break-before-make switching.

The MAX4763/MAX4765 feature a comparator that can be used for headphone or mute detection. The comparator threshold is internally generated to be approximately 1/3 of V_{CC} . The MAX4764/MAX4764A/MAX4765 feature an internal shunt switch to discharge any capacitance at the NO and NC connection points. This reduces the click-and-pop sounds that occur when switching audio signals.

Applications Information

Digital Control Inputs

The MAX4762-MAX4764/MAX4764A/MAX4765 logic inputs accept up to +5.5V, regardless of supply voltage. For example, with a +3.3V supply, IN_{-} can be driven low to GND and high to +5.5V allowing for mixing of logic levels in a system. Driving IN_{-} rail-to-rail minimizes power consumption. For a +1.8V supply voltage, the logic thresholds are 0.5V (low) and 1.4V (high); for a +5V supply voltage, the logic thresholds are 0.8V (low) and 2.0V (high).

Analog Signal Levels

The on-resistance of the MAX4762-MAX4764/MAX4764A/MAX4765 changes very little for analog input signals across the entire supply voltage range (see the *Typical Operating Characteristics*). The switches are bidirectional, so the NO_{-} , NC_{-} , and COM_{-} pins can be either inputs or outputs.

The MAX4762-MAX4764/MAX4764A/MAX4765 pass signals as low as $V_{CC} - 5.5V$, including signals below ground with minimal distortion.

Comparator (MAX4763/MAX4765)

The MAX4763/MAX4765 include a comparator that can be used for mute and headphone detection functions. The positive terminal of the comparator is internally set to $V_{CC} / 3$. When the negative terminal (CMP-) is below the threshold, the comparator output (CMPO) is a logic high. When CMP- rises above $V_{CC} / 3$, CMPO is a logic low.

The comparator threshold of $V_{CC} / 3$ allows for detection of headphones because headphone audio signals are typically biased to $V_{CC} / 2$.

Shunt Switch (MAX4764/MAX4764A/MAX4765)

The 100 Ω shunt switches on the MAX4764/MAX4764A/MAX4765 automatically discharge any capacitance at the NC_{-} or NO_{-} terminals when they are unconnected to COM_{-} . This reduces audible click-and-pop sounds that occur when switching between audio sources.

Audible clicks and pops are caused when a step DC voltage is switched into the speaker. By automatically discharging the side that is not connected, any residual DC voltage is removed, thereby reducing the clicks and pops.

Power-Supply Sequencing and Overvoltage Protection

Caution: Do not exceed the absolute maximum ratings since stresses beyond the listed ratings may cause permanent damage to the device.

Proper power-supply sequencing is recommended for all CMOS devices. Always apply V_{CC} before applying analog signals, especially if the analog signal is not current-limited.

UCSP Applications Information

For the latest application details on UCSP construction, dimensions, tape carrier information, printed circuit board techniques, bump-pad layout, and recommended reflow temperature profile, as well as the latest information on reliability testing results, go to the Maxim's website at www.maxim-ic.com/ucsp and search for the Application Note, "UCSP—A Wafer-Level Chip-Scale Package."

Low-Voltage, Dual SPDT, Audio Clickless Switches with Negative Rail Capability

Test Circuits/Timing Diagrams

MAX4762-MAX4764/MAX4764A/MAX4765



Figure 2. Switching Time



Figure 3. Break-Before-Make Interval



Figure 4. Charge Injection

Low-Voltage, Dual SPDT, Audio Clickless Switches with Negative Rail Capability

Test Circuits/Timing Diagrams (continued)

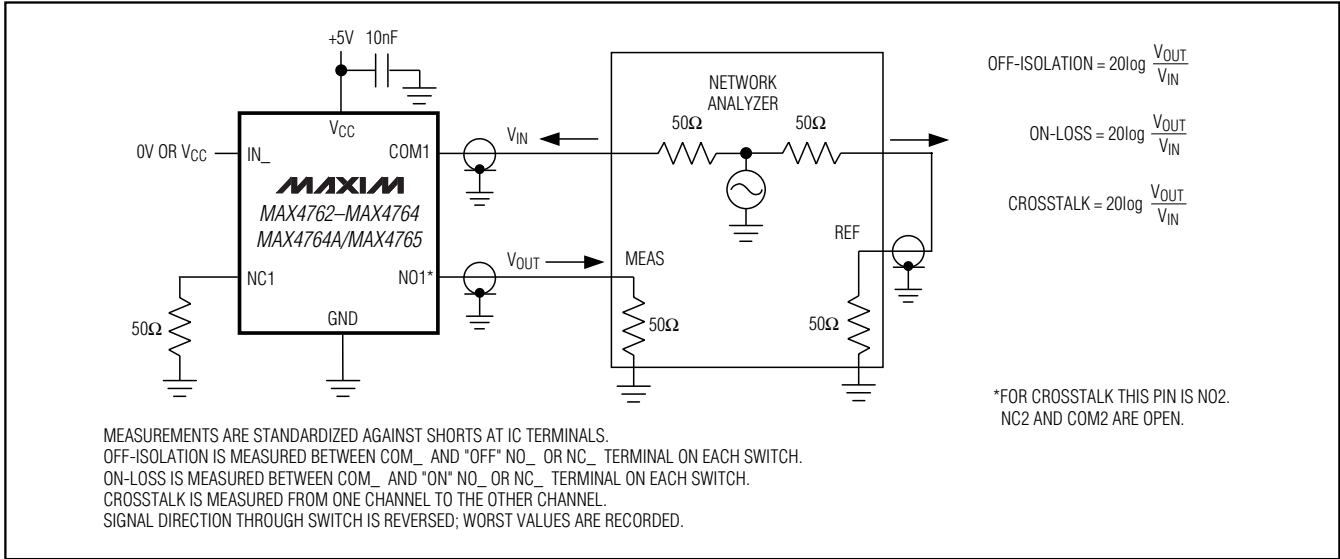

Figure 5. On-Loss, Off-Isolation, and Crosstalk

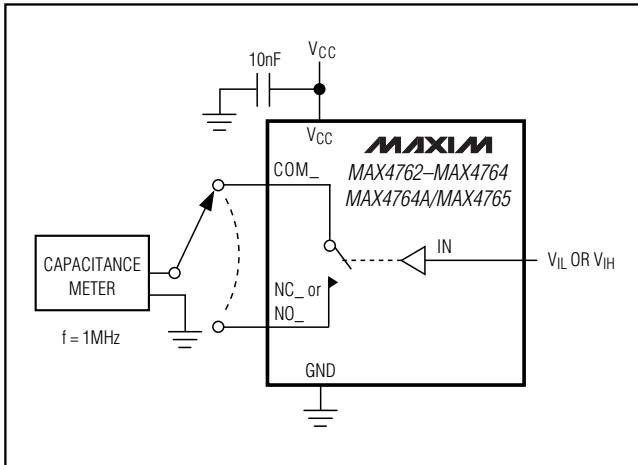

Figure 6. Channel Off/On-Capacitance

Low-Voltage, Dual SPDT, Audio Clickless Switches with Negative Rail Capability

Pin Configurations/Functional Diagrams/Truth Table (continued)



Selector Guide

PART	COMPARATOR	SHUNT	PACKAGE SIZE (mm)
MAX4762EBC-T	No	No	1.5 x 2.0
MAX4762ETB	No	No	3.0 x 3.0
MAX4762EUB	No	No	3.0 x 5.0
MAX4763EBC-T	Yes	No	1.5 x 2.0
MAX4763ETC	Yes	No	4.0 x 4.0
MAX4764EBC-T	No	Yes	1.5 x 2.0
MAX4764ETB	No	Yes	3.0 x 3.0
MAX4764AETB	No	Yes	3.0 x 3.0
MAX4764EUB	No	Yes	3.0 x 5.0
MAX4765EBC-T	Yes	Yes	1.5 x 2.0
MAX4765ETC	Yes	Yes	4.0 x 4.0

Ordering Information (continued)

PART	TEMP RANGE	PIN-PACKAGE	TOP MARK
MAX4763 EBC-T	-40°C to +85°C	12 UCSP-12	ABS
MAX4763ETC	-40°C to +85°C	12 Thin QFN	AAED
MAX4764 ETB	-40°C to +85°C	10 TDFN	ACH
MAX4764EUB	-40°C to +85°C	10 μMAX	—
MAX4764EBC-T	-40°C to +85°C	12 UCSP-12	ABV
MAX4764A ETB	-40°C to +85°C	10 TDFN	AQP
MAX4765 EBC-T	-40°C to +85°C	12 UCSP-12	ABT
MAX4765ETC	-40°C to +85°C	12 Thin QFN	AAEE

Chip Information

TRANSISTOR COUNT: 769

PROCESS: BICMOS

MAX4762-MAX4764/MAX4764A/MAX4765

Low-Voltage, Dual SPDT, Audio Clickless Switches with Negative Rail Capability

Package Information

(The package drawing(s) in this data sheet may not reflect the most current specifications. For the latest package outline information, go to www.maxim-ic.com/packages.)

TOP VIEW

COMMON DIMENSIONS	
A	0.62±0.05-0.08
A1	0.29±0.02
A2	0.33 REF.
b	∅0.35±0.03
D1	1.00 BASIC
E1	1.50 BASIC
e	0.50 BASIC
SD	0.00 BASIC
SE	0.25 BASIC

PKG. CODE	VARIABLE DIMENSIONS		DEPOPULATED SOLDER BALLS
	D	E	
B12-1	1.54±0.05	2.02±0.05	NONE
B12-2	1.54±0.05	2.02±0.05	B3
B12-3	1.54±0.05	2.12±0.05	NONE
B12-4	1.54±0.05	2.02±0.05	B2, B3
B12-5	1.64±0.05	2.12±0.05	B2
B12-6	1.64±0.05	2.12±0.05	B3
B12-7	1.54±0.05	2.02±0.05	B1, B3
B12-8	1.54±0.05	2.02±0.05	B2
B12-9	1.54±0.05	2.12±0.05	B2, B3
B12-10	1.54±0.05	2.02±0.05	B1, B2, B3, B4
B12-11	1.54±0.05	2.02±0.05	A2, C3

NOTES:

- ALL DIMENSIONS ARE IN MILLIMETERS.
- PRODUCT MARKING: NUMBER OF CHARACTERS AND LINES VARY PER PRODUCT.

BOTTOM VIEW

SIDE VIEW

12L UCSP 4x3 ERS

PROPRIETARY INFORMATION

TITLE: PACKAGE OUTLINE, 4x3 UCSP

APPROVAL	DOCUMENT CONTROL NO. 21-0104	REV. F	1/1
----------	------------------------------	--------	-----

Low-Voltage, Dual SPDT, Audio Clickless Switches with Negative Rail Capability

Package Information (continued)

(The package drawing(s) in this data sheet may not reflect the most current specifications. For the latest package outline information, go to www.maxim-ic.com/packages.)



COMMON DIMENSIONS							
SYMBOL	MIN.	MAX.					
A	0.70	0.80					
D	2.90	3.10					
E	2.90	3.10					
A1	0.00	0.05					
L	0.20	0.40					
k	0.25 MIN.						
A2	0.20 REF.						

PACKAGE VARIATIONS								
PKG. CODE	N	D2	E2	e	JEDEC SPEC	b	[(N/2)-1] x e	DOWNBONDS ALLOWED
T633-1	6	1.50±0.10	2.30±0.10	0.95 BSC	MO229 / WEEA	0.40±0.05	1.90 REF	NO
T633-2	6	1.50±0.10	2.30±0.10	0.95 BSC	MO229 / WEEA	0.40±0.05	1.90 REF	NO
T833-1	8	1.50±0.10	2.30±0.10	0.65 BSC	MO229 / WEEC	0.30±0.05	1.95 REF	NO
T833-2	8	1.50±0.10	2.30±0.10	0.65 BSC	MO229 / WEEC	0.30±0.05	1.95 REF	NO
T833-3	8	1.50±0.10	2.30±0.10	0.65 BSC	MO229 / WEEC	0.30±0.05	1.95 REF	YES
T1033-1	10	1.50±0.10	2.30±0.10	0.50 BSC	MO229 / WEED-3	0.25±0.05	2.00 REF	NO
T1433-1	14	1.70±0.10	2.30±0.10	0.40 BSC	----	0.20±0.05	2.40 REF	YES
T1433-2	14	1.70±0.10	2.30±0.10	0.40 BSC	----	0.20±0.05	2.40 REF	NO

NOTES:

1. ALL DIMENSIONS ARE IN mm. ANGLES IN DEGREES.
2. COPLANARITY SHALL NOT EXCEED 0.08 mm.
3. WARPAGE SHALL NOT EXCEED 0.10 mm.
4. PACKAGE LENGTH/PACKAGE WIDTH ARE CONSIDERED AS SPECIAL CHARACTERISTIC(S).
5. DRAWING CONFORMS TO JEDEC MO229, EXCEPT DIMENSIONS "D2" AND "E2", AND T1433-1 & T1433-2.
6. "N" IS THE TOTAL NUMBER OF LEADS.
7. NUMBER OF LEADS SHOWN ARE FOR REFERENCE ONLY.

-DRAWING NOT TO SCALE-

DALLAS SEMICONDUCTOR	MAXIM
TITLE: PACKAGE OUTLINE, 6,8,10 & 14L TDFN, EXPOSED PAD, 3x3x0.80 mm	
APPROVAL	DOCUMENT CONTROL NO. 21-0137
REV.	G 2/2

MAX4762-MAX4764/MAX4764A/MAX4765

Low-Voltage, Dual SPDT, Audio Clickless Switches with Negative Rail Capability

Package Information (continued)

(The package drawing(s) in this data sheet may not reflect the most current specifications. For the latest package outline information, go to www.maxim-ic.com/packages.)

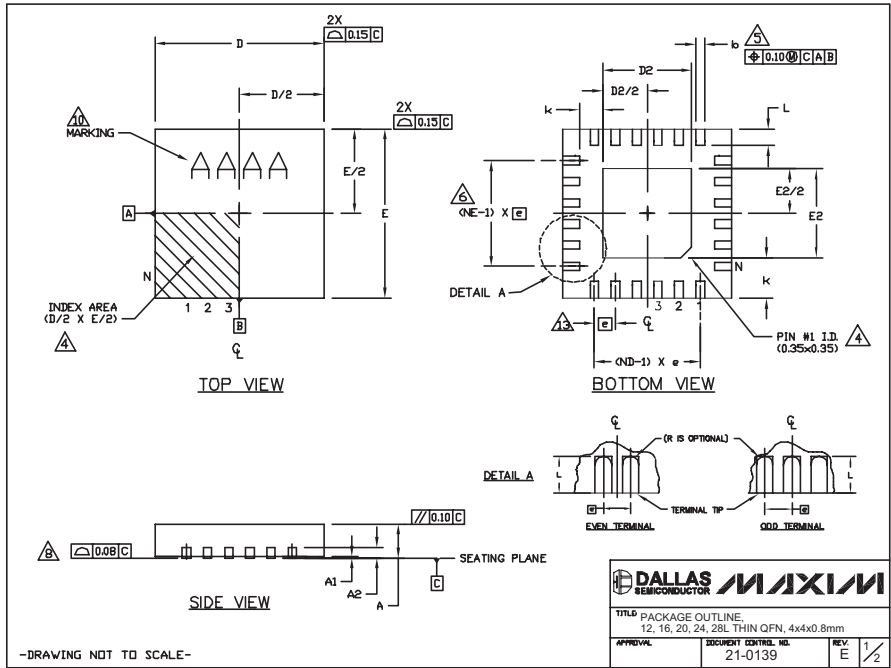

-DRAWING NOT TO SCALE-

DALLAS SEMICONDUCTOR MAXIM

TITLE PACKAGE OUTLINE,
12, 16, 20, 24, 28L THIN QFN, 4x4x0.8mm

APPROVAL	DOCUMENT CONTROL NO. 21-0139	REV. E	1/2
----------	---------------------------------	-----------	-----

COMMON DIMENSIONS													EXPOSED PAD VARIATIONS										
PKG REF.	12L 4x4			16L 4x4			20L 4x4			24L 4x4			28L 4x4			PKG CODES	D2			E2			DOWN PINS ALLOWED
	MIN.	NOM.	MAX.	MIN.	NOM.	MAX.	MIN.	NOM.	MAX.	MIN.	NOM.	MAX.	MIN.	NOM.	MAX.		MIN.	NOM.	MAX.	MIN.	NOM.	MAX.	
A	0.70	0.75	0.80	0.70	0.75	0.80	0.70	0.75	0.80	0.70	0.75	0.80	0.70	0.75	0.80	T1244-3	1.95	2.10	2.25	1.95	2.10	2.25	YES
A1	0.0	0.02	0.05	0.0	0.02	0.05	0.0	0.02	0.05	0.0	0.02	0.05	0.0	0.02	0.05	T1244-4	1.95	2.10	2.25	1.95	2.10	2.25	NO
A2	0.20 REF			0.20 REF			0.20 REF			0.20 REF			0.20 REF			T1644-3	1.95	2.10	2.25	1.95	2.10	2.25	YES
b	0.25	0.30	0.35	0.25	0.30	0.35	0.20	0.25	0.30	0.18	0.23	0.30	0.15	0.20	0.25	T1644-4	1.95	2.10	2.25	1.95	2.10	2.25	YES
D	3.90	4.00	4.10	3.90	4.00	4.10	3.90	4.00	4.10	3.90	4.00	4.10	3.90	4.00	4.10	T2844-2	1.95	2.10	2.25	1.95	2.10	2.25	YES
E	3.90	4.00	4.10	3.90	4.00	4.10	3.90	4.00	4.10	3.90	4.00	4.10	3.90	4.00	4.10	T2844-3	1.95	2.10	2.25	1.95	2.10	2.25	YES
e	0.80 BSC.			0.65 BSC.			0.50 BSC.			0.50 BSC.			0.40 BSC.			T2444-2	1.95	2.10	2.25	1.95	2.10	2.25	YES
k	0.25	-	-	0.25	-	-	0.25	-	-	0.25	-	-	0.25	-	-	T2444-3	2.45	2.60	2.63	2.45	2.60	2.63	YES
L	0.45	0.55	0.65	0.45	0.55	0.65	0.45	0.55	0.65	0.30	0.40	0.50	0.30	0.40	0.50	T2444-4	2.45	2.60	2.63	2.45	2.60	2.63	NO
N	12			16			20			24			28			T2844-1	2.50	2.60	2.70	2.50	2.60	2.70	NO
ND	3			4			5			6			7										
NE	3			4			5			6			7										
WGCG	VGG3			VGGC			VGGD-1			VGGD-2			VGGE										

NOTES:

- DIMENSIONING & TOLERANCING CONFORM TO ASME Y14.5M-1994.
- ALL DIMENSIONS ARE IN MILLIMETERS, ANGLES ARE IN DEGREES.
- N IS THE TOTAL NUMBER OF TERMINALS.
- THE TERMINAL #1 IDENTIFIER AND TERMINAL NUMBERING CONVENTION SHALL CONFORM TO JEDEC 93-1 SPP-012. DETAILS OF TERMINAL #1 IDENTIFIER ARE OPTIONAL, BUT MUST BE LOCATED WITHIN THE ZONE INDICATED. THE TERMINAL #1 IDENTIFIER MAY BE EITHER A MOLD OR MARKED FEATURE.
- DIMENSION b APPLIES TO METALLIZED TERMINAL AND IS MEASURED BETWEEN 0.25 mm AND 0.30 mm FROM TERMINAL TIP.
- ND AND NE REFER TO THE NUMBER OF TERMINALS ON EACH D AND E SIDE RESPECTIVELY.
- DEPOPULATION IS POSSIBLE IN A SYMMETRICAL FASHION.
- COPLANARITY APPLIES TO THE EXPOSED HEAT SINK SLUG AS WELL AS THE TERMINALS.
- DRAWING CONFORMS TO JEDEC M0220, EXCEPT FOR T2444-3, T2444-4 AND T2844-1.
- MARKING IS FOR PACKAGE ORIENTATION REFERENCE ONLY.
- COPLANARITY SHALL NOT EXCEED 0.08mm
- WARRPAGE SHALL NOT EXCEED 0.10mm
- LEAD CENTERLINES TO BE AT TRUE POSITION AS DEFINED BY BASIC DIMENSION "e", ±0.05.
- NUMBER OF LEADS SHOWN ARE FOR REFERENCE ONLY.

-DRAWING NOT TO SCALE-

DALLAS SEMICONDUCTOR MAXIM

TITLE PACKAGE OUTLINE,
12, 16, 20, 24, 28L THIN QFN, 4x4x0.8mm

APPROVAL	DOCUMENT CONTROL NO. 21-0139	REV. E	2/2
----------	---------------------------------	-----------	-----

Low-Voltage, Dual SPDT, Audio Clickless Switches with Negative Rail Capability

Package Information (continued)

(The package drawing(s) in this data sheet may not reflect the most current specifications. For the latest package outline information, go to www.maxim-ic.com/packages.)

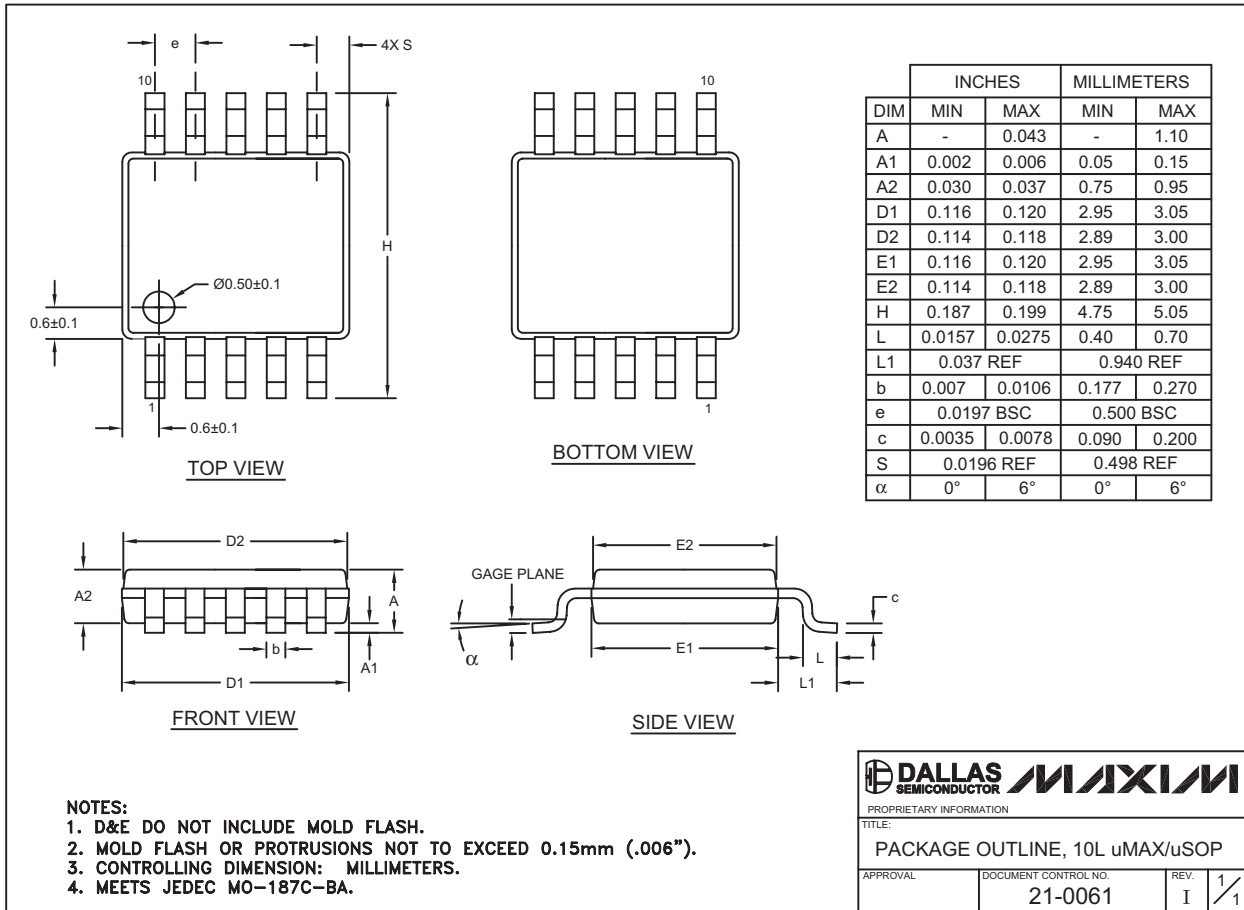

10LUMAX:EPS

MAX4762-MAX4764/MAX4764A/MAX4765

Maxim cannot assume responsibility for use of any circuitry other than circuitry entirely embodied in a Maxim product. No circuit patent licenses are implied. Maxim reserves the right to change the circuitry and specifications without notice at any time.

Maxim Integrated Products, 120 San Gabriel Drive, Sunnyvale, CA 94086 408-737-7600 _____ 15