

# QH series

Halo LED illumination



## DISTINCTIVE FEATURES

Single, dual and RGB colors available

Designed to integrate with Ø16, Ø19 and Ø22 mm panel cutout switches and other APEM indicators

Ø22 mm oversized version for integration with APEM's range of Emergency Stop switches

Panel sealed up to IP67

200 mm 26 AWG UL1061 wire terminations



## ENVIRONMENTAL SPECIFICATIONS

- Panel Seal : IP67 to EN60529 : 1992
- EMC Immunity : EN61000-4-3, 100V/m, extended to radiated fields in frequency range of 80MHz-2.7GHz, 1kHz 80% sine wave modulation
- EMC Emissions : EN61000-6-4 : 2011, Class B 30Mhz-11Ghz
- Electrostatic Discharge : EN61000-4-2 up to +/- 15 KV
- Operating Temperature Range : -30 °C to +70 °C (-22 °F to +158 °F)



## GENERAL SPECIFICATIONS

- Max Reverse Voltage : 5 VDC
- Life Expectancy : 50,000 Hours
- Single color PCB : 12 LED's
- Dual color PCB : 12 LED's, 6 of each (alternately placed)
- RGB color PCB : 12 LED's



## MATERIALS

- Body : PC
- Lens : PC

The company reserves the right to change specifications without notice.

LED characteristics are dependent upon environmental conditions. Therefore published data should be considered nominal and subject to variations.



# QH series

Halo LED illumination



## ELECTRICAL SPECIFICATIONS

Voltage	Operating Voltage	Operating Current
	(Min to Max)	(Typical All Types)
12 VDC to 24 VDC	12.0 to 26.4	4.2 mA to 20 mA

\* Customer to supply resistor for desired operating current.

### STANDARD LED INTENSITY

LED COMPONENT SPECIFICATIONS		
	Intensity	Forward Voltage (typical)
HE Red	120 mcd	2.0 V
Green	350 mcd	3.1 V
Yellow	90 mcd	2.0 V
Blue	90 mcd	3.1 V
White	350 mcd	3.1 V

### RGB LED INTENSITY

LED COMPONENT SPECIFICATIONS		
	Intensity	Forward Voltage (typical)
Red	100 mcd	2.0 V
Green	300 mcd	3.0 V
Blue	90 mcd	3.0 V

- The operating voltage must not be exceeded by more than 10% as this will result in reduced life expectancy
- Luminous intensity is measured at 20 mA on a discrete led unless otherwise stated.
- Luminous intensities and color shades of white LEDs may vary within a batch.
- Luminous intensity will be reduced with lower operating current.



## MOUNTING

### PANEL CUT-OUT

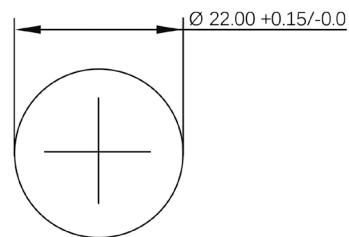
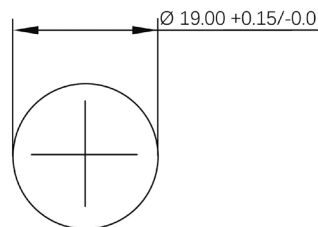
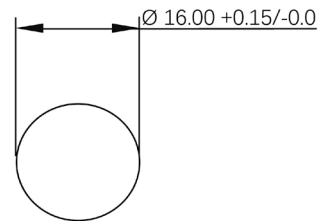



### CIRCUIT DIAGRAM

QH16, QH19, QH22

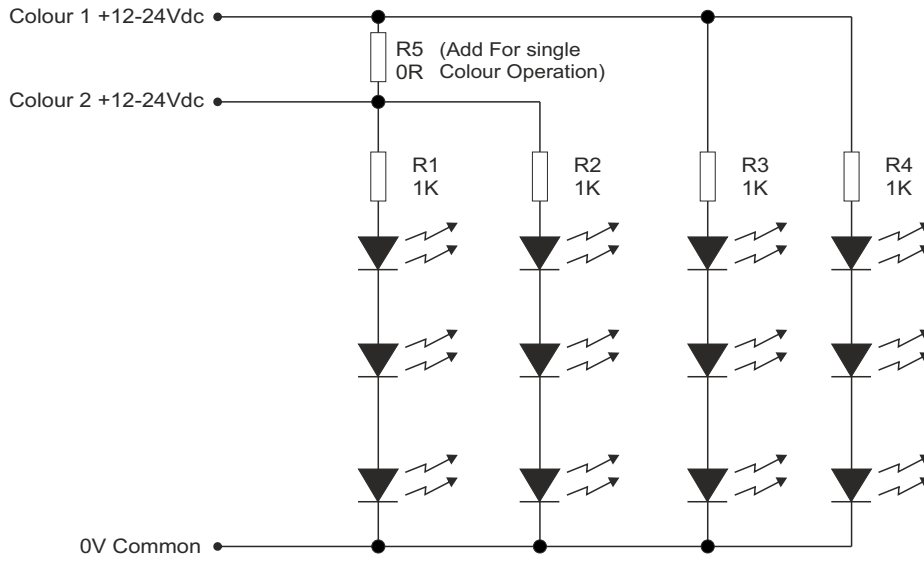

QH22L

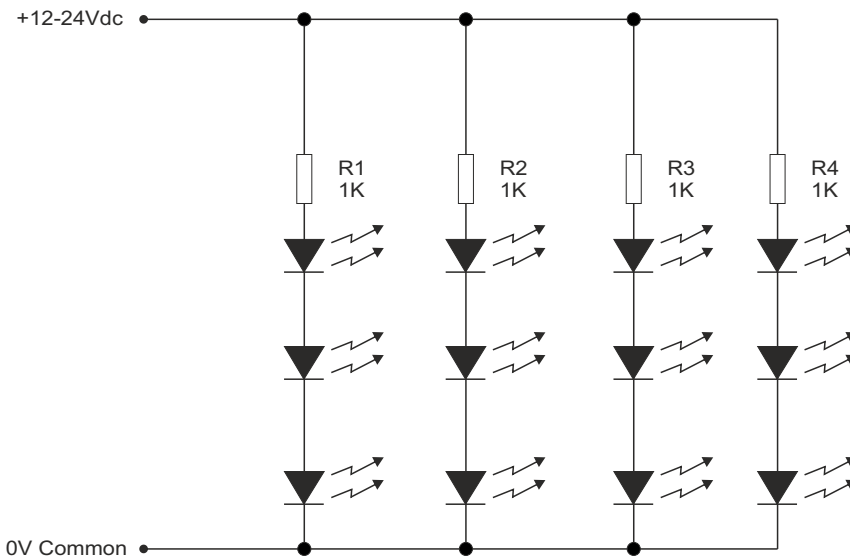

# QH series

Halo LED illumination



## CIRCUIT DIAGRAM (CONTINUED)

QH16, QH19, QH22 RGB

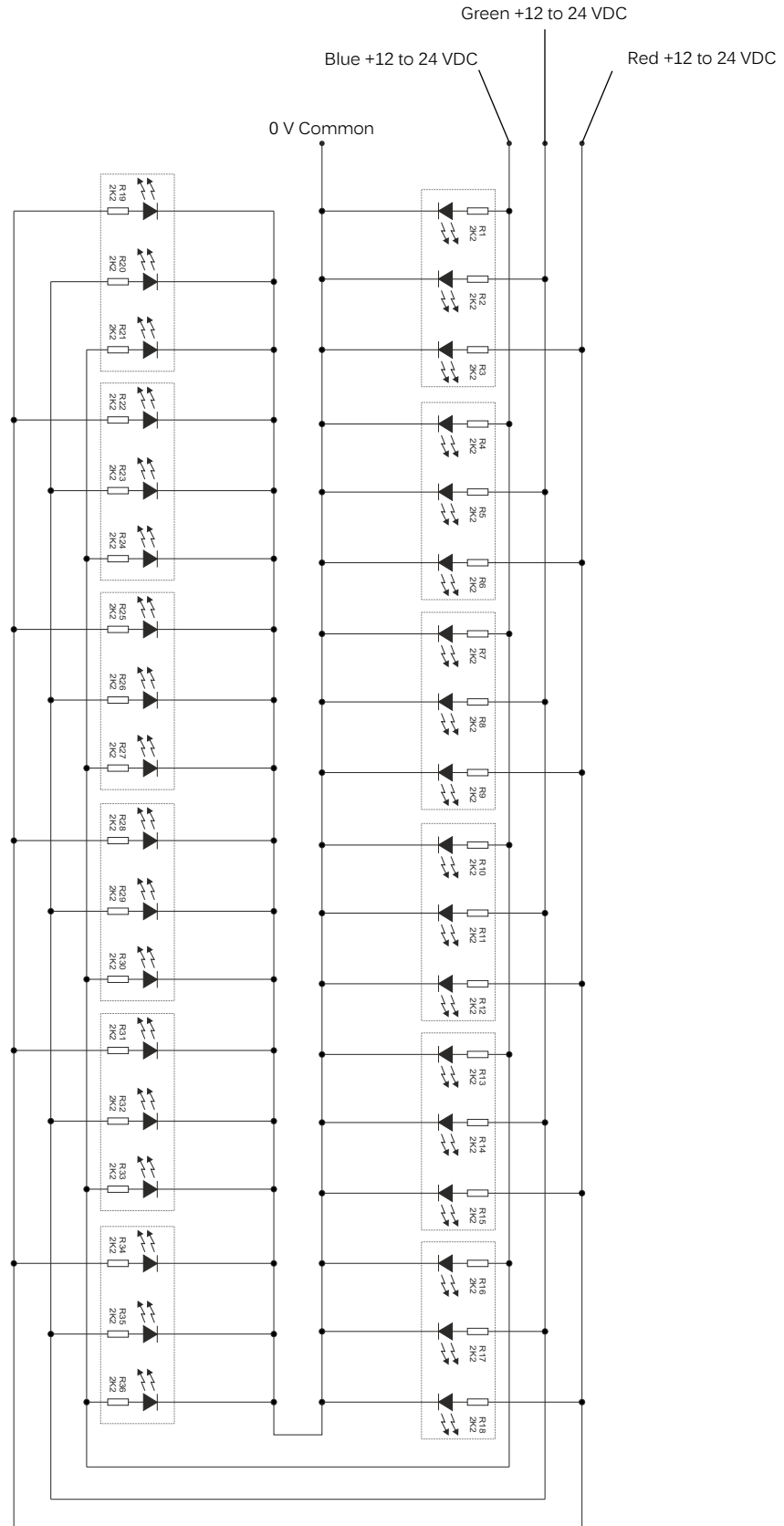



### BUILD YOUR PART NUMBER

SERIES	SIZE	BEZEL COLOR	LENS COLOR	LED COLOR	SEALING
<b>QH</b>					
	<b>160</b> 16 mm cutout	<b>2</b> Black	<b>7</b> Frosted White	<b>Single LED</b>	<b>U</b> Unsealed
	<b>190</b> 19 mm cutout	<b>5</b> Yellow	<b>8</b> Tinted	<b>R</b> Red	<b>C</b> IP67 (panel seal)
	<b>220</b> 22 mm cutout			<b>G</b> Green	
	<b>22L</b> 22 mm cutout			<b>Y</b> Yellow	
				<b>B</b> Blue	
				<b>W</b> White (clear)	
				<b>RGB LED</b>	
				<b>RGB</b> RGB	
				<b>Dual LED</b>	
				<b>RG</b> Red/Green	
				<b>RY</b> Red/Yellow	
				<b>BW</b> Blue/White	



**QH22L57YC**

Shown fitted to an Emergency Stop switch



### ABOUT THIS SERIES

- Standard wire length is 200 mm, 26 AWG UL1061, for other wire lengths please contact APEM
- Colored wire denotes Anode (+), black wire denotes Cathode (-)
- Supply voltage is 12 to 24 VDC, for alternative voltages please contact APEM
- Dual color LEDs are alternately placed on the internal PCB, by connecting one colored wire (+) a color is produced, by connecting the other colored wire (+) the second color is produced
- When implementing full-spectrum RGB the customer should supply an external Microcontroller driver

# QH series

Halo LED illumination

QH16 - 16 MM (.634")

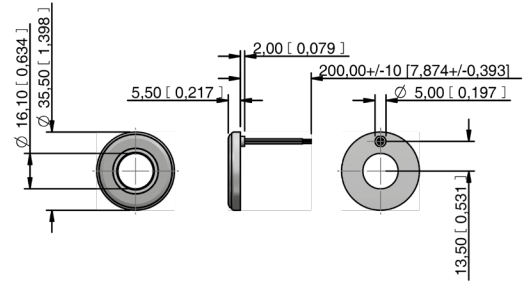

QH19 - 19 MM (.752")

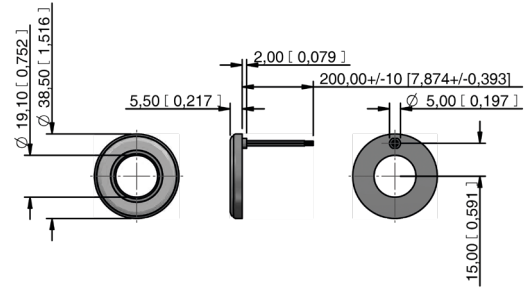

QH22 - 22 MM (.872")

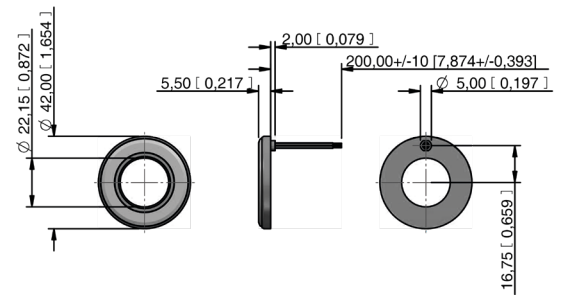

QH22L - 22 MM (.872") - OVERSIZED

