

31 A, 600 V, very fast IGBT with Ultrafast diode

Features

- Low on-voltage drop ($V_{CE(sat)}$)
- Very soft Ultrafast recovery anti-parallel diode

Applications

- High frequency motor drives
- SMPS and PFC in both hard switch and resonant topologies

Description

This device is an ultrafast IGBT. It utilizes the advanced Power MESH™ process resulting in an excellent trade-off between switching performance and low on-state behavior.

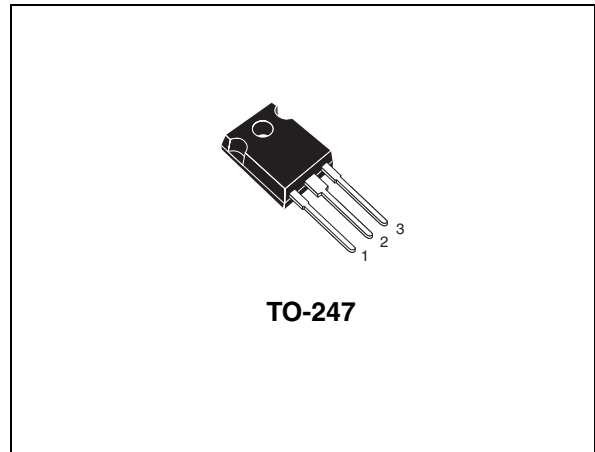

Figure 1. Internal schematic diagram

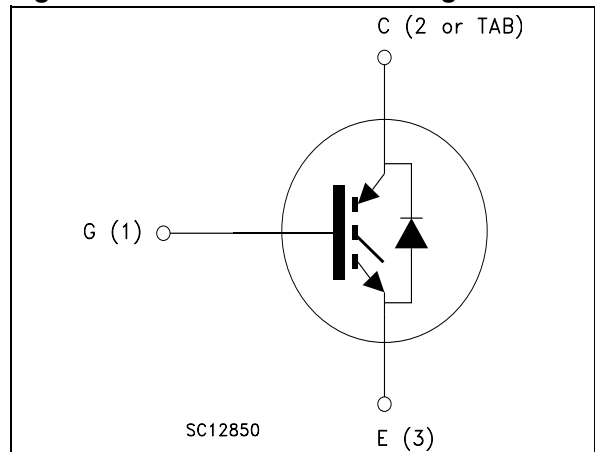

Table 1. Device summary

Part number	Marking	Package	Packaging
STGWA19NC60HD	GWA19NC60HD	TO-247 long leads	Tube

Contents

1	Electrical ratings	3
2	Electrical characteristics	4
	2.1 Electrical characteristics (curves)	6
3	Test circuits	9
4	Package mechanical data	10
5	Revision history	13

1 Electrical ratings

Table 2. Absolute maximum ratings

Symbol	Parameter	Value	Unit
V_{CES}	Collector-emitter voltage ($V_{GE} = 0$)	600	V
$I_C^{(1)}$	Continuous collector current at $T_C = 25\text{ °C}$	52	A
$I_C^{(1)}$	Continuous collector current at $T_C = 100\text{ °C}$	31	A
$I_{CL}^{(2)}$	Turn-off latching current	40	A
$I_{CP}^{(3)}$	Pulsed collector current	60	A
I_F	Diode RMS forward current at $T_C = 25\text{ °C}$	20	A
I_{FSM}	Surge not repetitive forward current $t_p=10\text{ ms}$ sinusoidal	50	A
V_{GE}	Gate-emitter voltage	± 20	V
P_{TOT}	Total dissipation at $T_C = 25\text{ °C}$	208	W
T_J	Operating junction temperature	- 55 to 150	°C

1. Calculated according to the iterative formula:

$$I_C(T_C) = \frac{T_{j(max)} - T_C}{R_{thj-c} \times V_{CE(sat)(max)}(T_{j(max)}, I_C(T_C))}$$

2. $V_{clamp} = 80\%V_{CES}$, $T_J = 150\text{ °C}$, $R_G = 10\ \Omega$, $V_{GE} = 15\text{ V}$

3. Pulse width limited by maximum permissible junction temperature and turn-off within RBSOA

Table 3. Thermal data

Symbol	Parameter	Value	Unit
R_{thJC}	Thermal resistance junction-case IGBT	0.6	°C/W
	Thermal resistance junction-case diode	3	°C/W
R_{thJA}	Thermal resistance junction-ambient	50	°C/W

2 Electrical characteristics

$T_J = 25\text{ °C}$ unless otherwise specified)

Table 4. Static

Symbol	Parameter	Test conditions	Min.	Typ.	Max.	Unit
$V_{(BR)CES}$	Collector-emitter breakdown voltage ($V_{GE} = 0$)	$I_C = 1\text{ mA}$	600			V
$V_{CE(sat)}$	Collector-emitter saturation voltage	$V_{GE} = 15\text{ V}, I_C = 12\text{ A}$ $V_{GE} = 15\text{ V}, I_C = 15\text{ A}$ $V_{GE} = 15\text{ V}, I_C = 30\text{ A}, T_J = 100\text{ °C}$ $V_{GE} = 15\text{ V}, I_C = 12\text{ A}, T_J = 125\text{ °C}$		1.8 2 2.5 1.6	2.5	V
$V_{GE(th)}$	Gate threshold voltage	$V_{CE} = V_{GE}, I_C = 250\text{ }\mu\text{A}$	3.75		5.75	V
I_{CES}	Collector cut-off current ($V_{GE} = 0$)	$V_{CE} = 600\text{ V}$ $V_{CE} = 600\text{ V}, T_J = 125\text{ °C}$			150 1	μA mA
I_{GES}	Gate-emitter leakage current ($V_{CE} = 0$)	$V_{GE} = \pm 20\text{ V}$			± 100	nA
$g_{fs}^{(1)}$	Forward transconductance	$V_{CE} = 15\text{ V}, I_C = 12\text{ A}$		5		S

1. Pulsed: pulse duration = 300 μs , duty cycle 1.5%

Table 5. Dynamic

Symbol	Parameter	Test conditions	Min.	Typ.	Max.	Unit
C_{ies}	Input capacitance			1180		pF
C_{oes}	Output capacitance	$V_{CE} = 25\text{ V}, f = 1\text{ MHz},$	-	130	-	pF
C_{res}	Reverse transfer capacitance	$V_{GE} = 0$		36		pF
Q_g	Total gate charge	$V_{CE} = 390\text{ V}, I_C = 5\text{ A},$		53		nC
Q_{ge}	Gate-emitter charge	$V_{GE} = 15\text{ V},$	-	10	-	nC
Q_{gc}	Gate-collector charge	Figure 18		23		nC

Table 6. Switching on/off (inductive load)

Symbol	Parameter	Test conditions	Min.	Typ.	Max.	Unit
$t_{d(on)}$ t_r $(di/dt)_{on}$	Turn-on delay time Current rise time Turn-on current slope	$V_{CC} = 390\text{ V}$, $I_C = 12\text{ A}$ $R_G = 10\ \Omega$, $V_{GE} = 15\text{ V}$, <i>Figure 19</i>	-	25 7 1600	-	ns ns A/ μ s
$t_{d(on)}$ t_r $(di/dt)_{on}$	Turn-on delay time Current rise time Turn-on current slope	$V_{CC} = 390\text{ V}$, $I_C = 12\text{ A}$ $R_G = 10\ \Omega$, $V_{GE} = 15\text{ V}$, $T_J = 125\text{ }^\circ\text{C}$ <i>Figure 19</i>	-	24 8 1400	-	ns ns A/ μ s
$t_{r(Voff)}$ $t_{d(Voff)}$ t_f	Off voltage rise time Turn-off delay time Current fall time	$V_{CC} = 390\text{ V}$, $I_C = 12\text{ A}$ $R_G = 10\ \Omega$, $V_{GE} = 15\text{ V}$, <i>Figure 19</i>	-	27 97 73	-	ns ns ns
$t_{r(Voff)}$ $t_{d(Voff)}$ t_f	Off voltage rise time Turn-off delay time Current fall time	$V_{CC} = 390\text{ V}$, $I_C = 12\text{ A}$ $R_G = 10\ \Omega$, $V_{GE} = 15\text{ V}$, $T_J = 125\text{ }^\circ\text{C}$ <i>Figure 19</i>	-	58 144 128	-	ns ns ns

Table 7. Switching energy (inductive load)

Symbol	Parameter	Test conditions	Min.	Typ.	Max.	Unit
E_{on} $E_{off}^{(1)}$ E_{ts}	Turn-on switching losses Turn-off switching losses Total switching losses	$V_{CC} = 390\text{ V}$, $I_C = 12\text{ A}$ $R_G = 10\ \Omega$, $V_{GE} = 15\text{ V}$, <i>Figure 19</i>	-	85 189 274	-	μ J μ J μ J
E_{on} $E_{off}^{(1)}$ E_{ts}	Turn-on switching losses Turn-off switching losses Total switching losses	$V_{CC} = 390\text{ V}$, $I_C = 12\text{ A}$ $R_G = 10\ \Omega$, $V_{GE} = 15\text{ V}$, $T_J = 125\text{ }^\circ\text{C}$ <i>Figure 19</i>	-	187 407 594	-	μ J μ J μ J

1. Turn-off losses include also the tail of the collector current

Table 8. Collector-emitter diode

Symbol	Parameter	Test conditions	Min.	Typ.	Max.	Unit
V_F	Forward on-voltage	$I_F = 12\text{ A}$ $I_F = 12\text{ A}$, $T_J = 125\text{ }^\circ\text{C}$	-	2.6 2.1	-	V V
t_{rr} Q_{rr} I_{rrm}	Reverse recovery time Reverse recovery charge Reverse recovery current	$I_F = 12\text{ A}$, $V_R = 40\text{ V}$, $di/dt = 100\text{ A}/\mu\text{s}$ <i>Figure 20</i>	-	31 30 2	-	ns nC A
t_{rr} Q_{rr} I_{rrm}	Reverse recovery time Reverse recovery charge Reverse recovery current	$I_F = 12\text{ A}$, $V_R = 40\text{ V}$, $T_J = 125\text{ }^\circ\text{C}$, $di/dt = 100\text{ A}/\mu\text{s}$ <i>Figure 20</i>	-	59 102 4	-	ns nC A

2.1 Electrical characteristics (curves)

Figure 2. Output characteristics

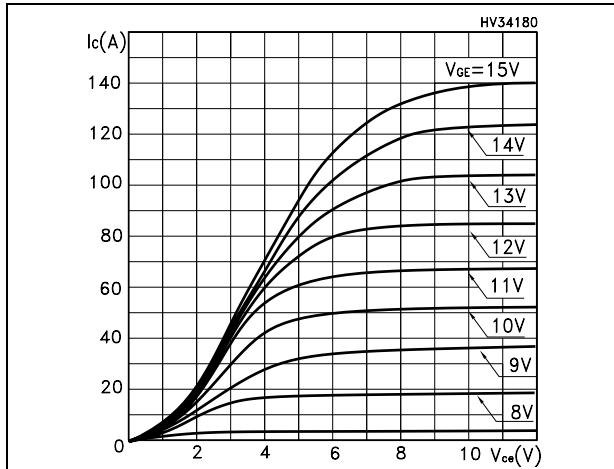

Figure 3. Transfer characteristics

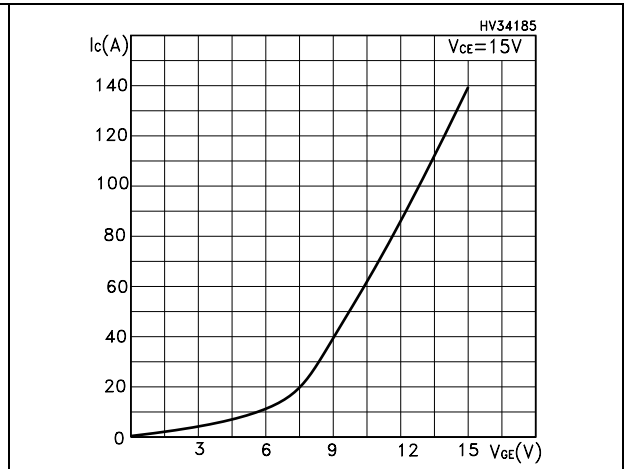

Figure 4. Transconductance

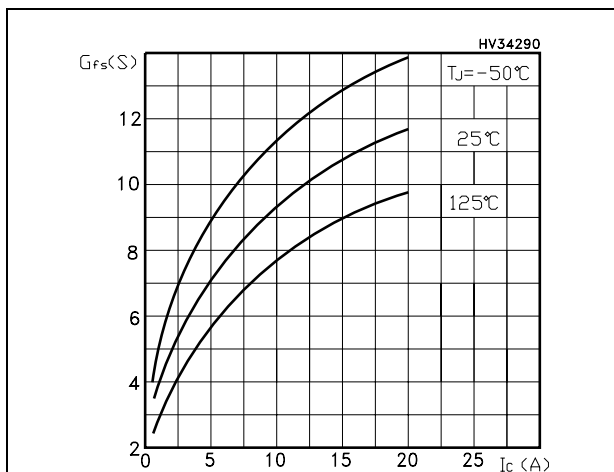

Figure 5. Collector-emitter on voltage vs. temperature

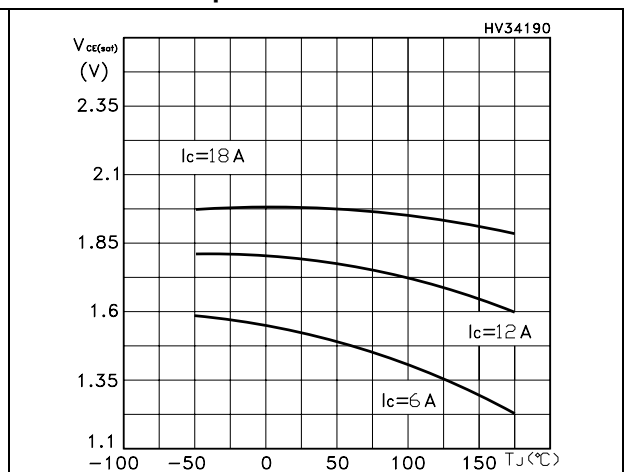

Figure 6. Gate charge vs. gate-source voltage

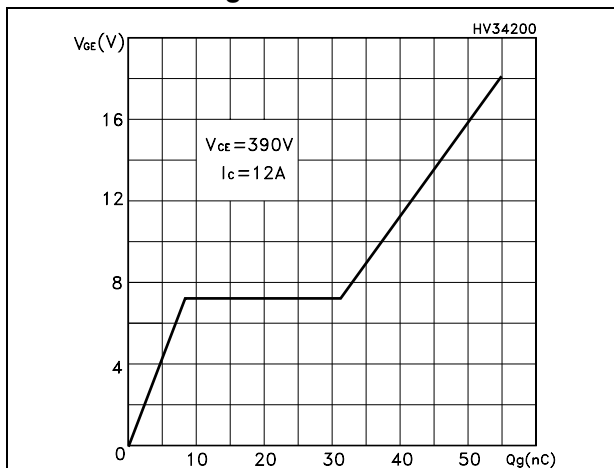

Figure 7. Capacitance variations

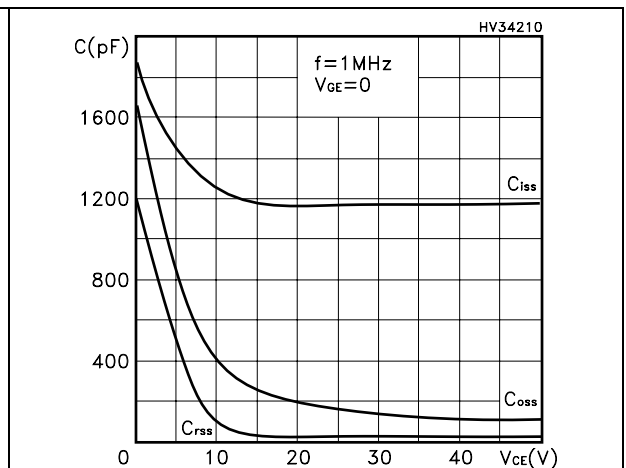

Figure 8. Normalized gate threshold voltage vs. temperature

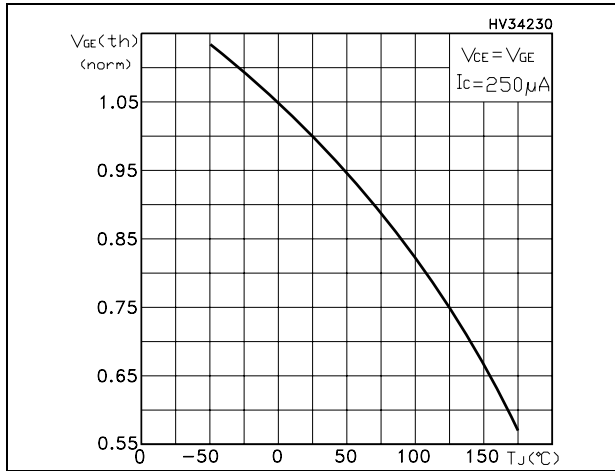

Figure 9. Collector-emitter on voltage vs. collector current

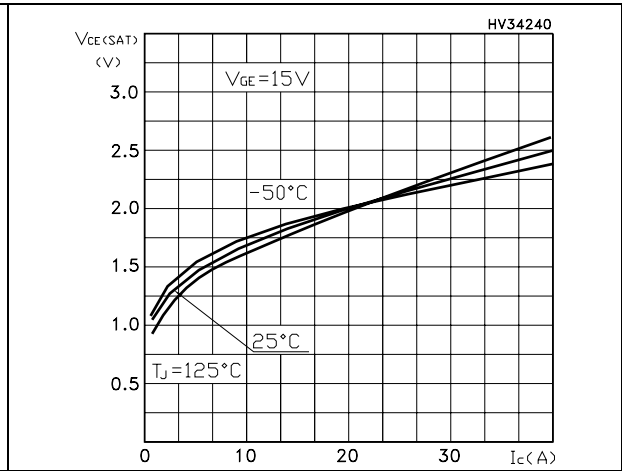

Figure 10. Normalized breakdown voltage vs. temperature

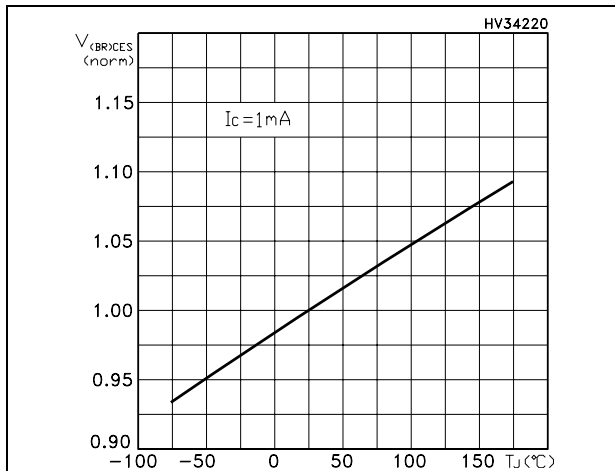

Figure 11. Switching losses vs. temperature

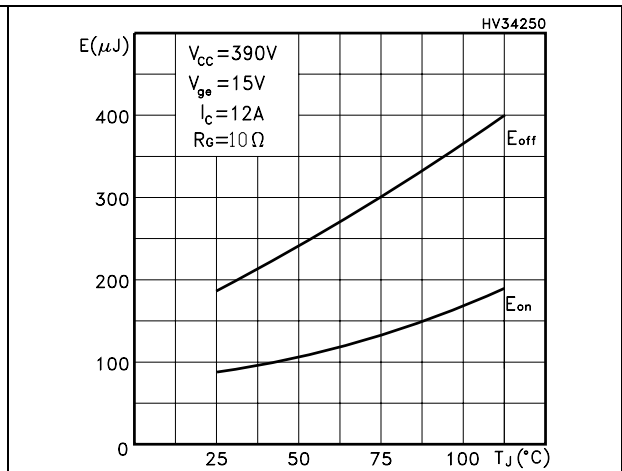

Figure 12. Switching losses vs. gate resistance

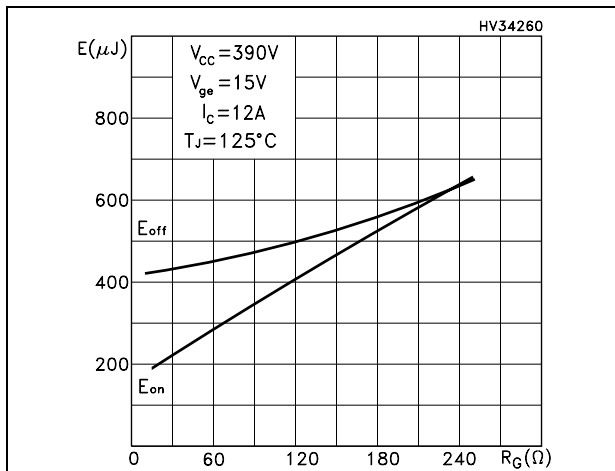

Figure 13. Switching losses vs. collector current

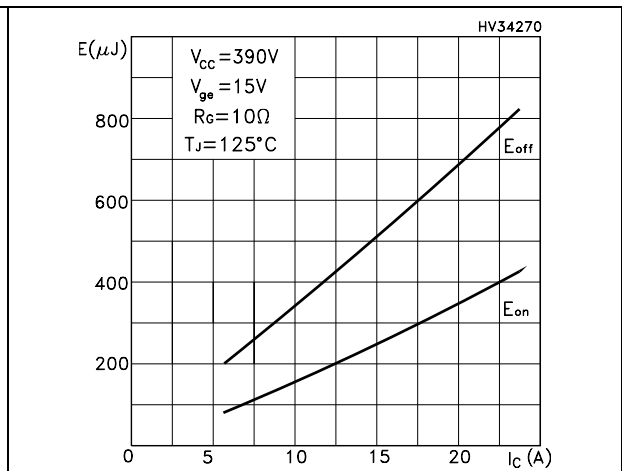

Figure 14. Turn-off SOA

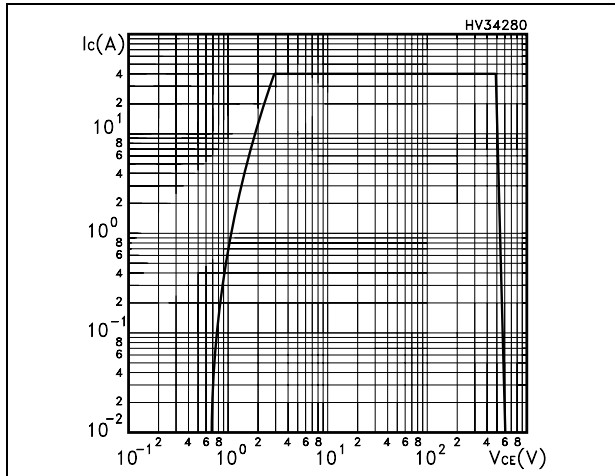

Figure 15. Thermal impedance

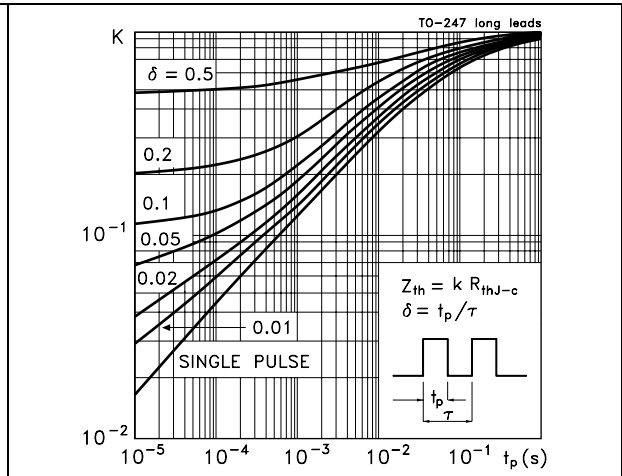
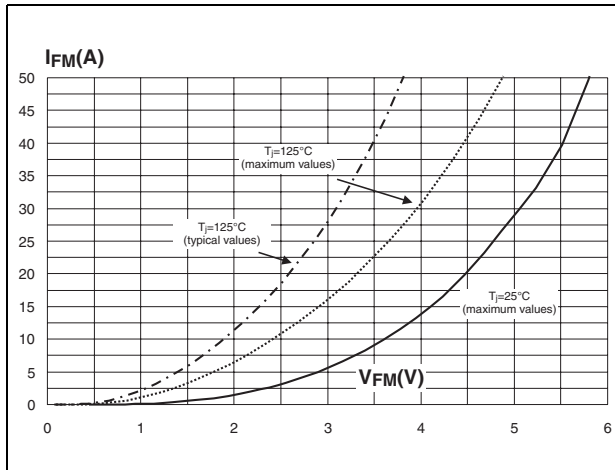
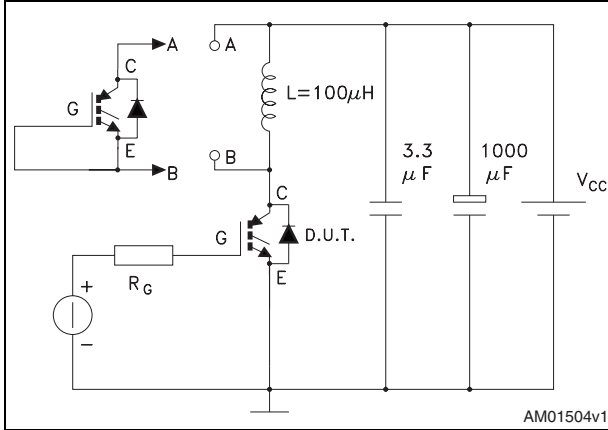

Figure 16. Forward voltage drop vs. forward current



3 Test circuits

Figure 17. Test circuit for inductive load switching



AM01504v1

Figure 18. Gate charge test circuit

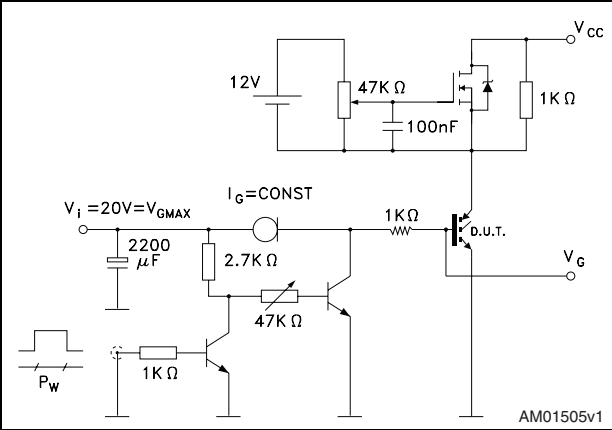

AM01505v1

Figure 19. Switching waveform

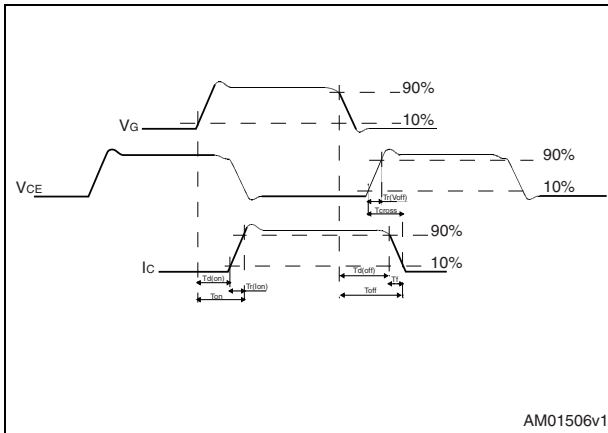

AM01506v1

Figure 20. Diode recovery time waveform

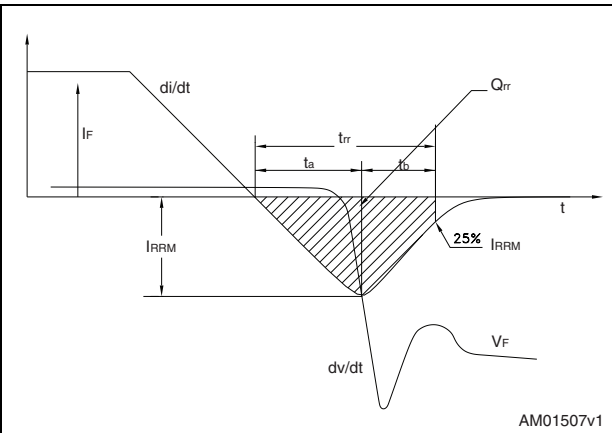

AM01507v1

4 Package mechanical data

In order to meet environmental requirements, ST offers these devices in different grades of ECOPACK[®] packages, depending on their level of environmental compliance. ECOPACK[®] specifications, grade definitions and product status are available at: www.st.com. ECOPACK is an ST trademark.

Table 9. TO-247 long leads mechanical data

Dim.	mm.		
	Min.	Typ.	Max.
A	4.90		5.15
D	1.85		2.10
E	0.55		0.67
F	1.07		1.32
F1	1.90		2.38
F2	2.87		3.38
G	10.90 BSC		
H	15.77		16.02
L	20.82		21.07
L1	4.16		4.47
L2	5.49		5.74
L3	20.05		20.30
L4	3.68		3.93
L5	6.04		6.29
M	2.27		2.52
V		10°	
V1		3°	
V3		20°	
Dia.	3.55		3.66

Figure 21. TO-247 long leads drawing

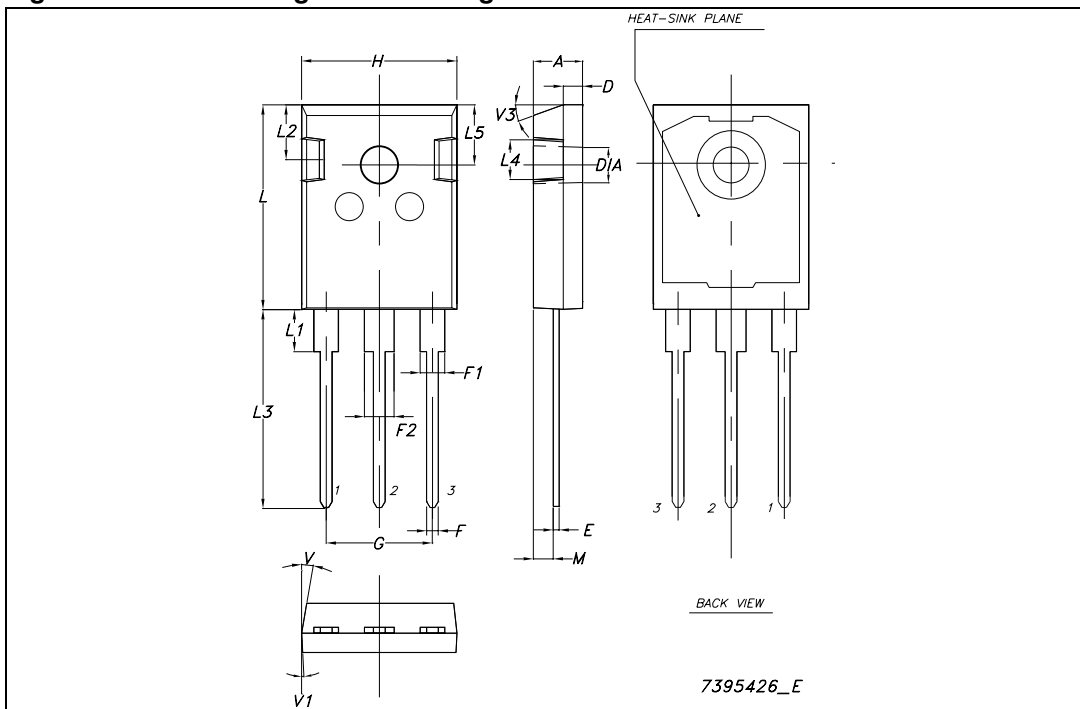

5 Revision history

Table 10. Document revision history

Date	Revision	Changes
14-Sep-2011	1	Initial release.

Please Read Carefully:

Information in this document is provided solely in connection with ST products. STMicroelectronics NV and its subsidiaries ("ST") reserve the right to make changes, corrections, modifications or improvements, to this document, and the products and services described herein at any time, without notice.

All ST products are sold pursuant to ST's terms and conditions of sale.

Purchasers are solely responsible for the choice, selection and use of the ST products and services described herein, and ST assumes no liability whatsoever relating to the choice, selection or use of the ST products and services described herein.

No license, express or implied, by estoppel or otherwise, to any intellectual property rights is granted under this document. If any part of this document refers to any third party products or services it shall not be deemed a license grant by ST for the use of such third party products or services, or any intellectual property contained therein or considered as a warranty covering the use in any manner whatsoever of such third party products or services or any intellectual property contained therein.

UNLESS OTHERWISE SET FORTH IN ST'S TERMS AND CONDITIONS OF SALE ST DISCLAIMS ANY EXPRESS OR IMPLIED WARRANTY WITH RESPECT TO THE USE AND/OR SALE OF ST PRODUCTS INCLUDING WITHOUT LIMITATION IMPLIED WARRANTIES OF MERCHANTABILITY, FITNESS FOR A PARTICULAR PURPOSE (AND THEIR EQUIVALENTS UNDER THE LAWS OF ANY JURISDICTION), OR INFRINGEMENT OF ANY PATENT, COPYRIGHT OR OTHER INTELLECTUAL PROPERTY RIGHT.

UNLESS EXPRESSLY APPROVED IN WRITING BY TWO AUTHORIZED ST REPRESENTATIVES, ST PRODUCTS ARE NOT RECOMMENDED, AUTHORIZED OR WARRANTED FOR USE IN MILITARY, AIR CRAFT, SPACE, LIFE SAVING, OR LIFE SUSTAINING APPLICATIONS, NOR IN PRODUCTS OR SYSTEMS WHERE FAILURE OR MALFUNCTION MAY RESULT IN PERSONAL INJURY, DEATH, OR SEVERE PROPERTY OR ENVIRONMENTAL DAMAGE. ST PRODUCTS WHICH ARE NOT SPECIFIED AS "AUTOMOTIVE GRADE" MAY ONLY BE USED IN AUTOMOTIVE APPLICATIONS AT USER'S OWN RISK.

Resale of ST products with provisions different from the statements and/or technical features set forth in this document shall immediately void any warranty granted by ST for the ST product or service described herein and shall not create or extend in any manner whatsoever, any liability of ST.

ST and the ST logo are trademarks or registered trademarks of ST in various countries.

Information in this document supersedes and replaces all information previously supplied.

The ST logo is a registered trademark of STMicroelectronics. All other names are the property of their respective owners.

© 2011 STMicroelectronics - All rights reserved

STMicroelectronics group of companies

Australia - Belgium - Brazil - Canada - China - Czech Republic - Finland - France - Germany - Hong Kong - India - Israel - Italy - Japan - Malaysia - Malta - Morocco - Philippines - Singapore - Spain - Sweden - Switzerland - United Kingdom - United States of America

www.st.com