

# CLINCHER™

Connector System for Flexible Circuitry (0.100in./ 2.54mm pitch)  
Maximum reliability; Low applied cost

## OVERVIEW

The CLINCHER™ connector family includes single-row pin and receptacle connectors designed for termination to flat flexible circuitry. Products are available for Flat Flexible Cable (FFC), Flexible Printed Circuit (FPC), and Conductive Ink Circuitry (CIC).

The connectors include features that optimize reliability at both the termination and disconnect interfaces. “Clinch” cable termination produces gas-tight, contamination-free connections to each conductor. The receptacle connectors utilize FCI’s proven and highly-reliable Mini PV™ contact design. Complementary shrouded PCB headers provide options for latching and proper connector alignment.

Contacts are pre-loaded to connector housings enabling mass termination to unprepared cable. The CLINCHER™ connector mass termination design accelerates cable assembly processes and reduces costs.

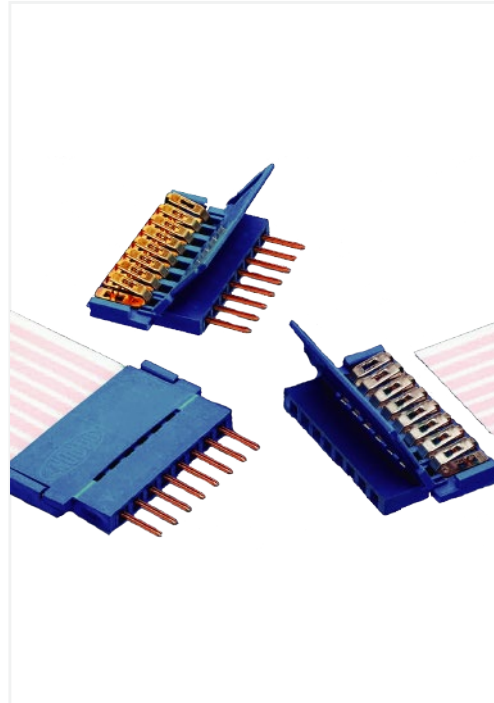

## FEATURES & BENEFITS

- “Clinch” cable termination provides four gas-tight, contamination-free contact points to each conductor
- Receptacle design features highly-reliable Mini PV dual-metal contacts
- Mass termination to unprepared cable reduces assembly costs
- Housing window permits crimp inspection to verify proper termination
- Receptacle openings feature a beveled “lead-in” to reduce risk of stubbing with mating pins
- Connector sizes range from 2 to 34 positions
- Polarization options aid proper alignment and mating
- Positive-locking, latching options assure secure mating to industry-standard headers for severe applications
- Economy two-wall PCB headers provide passive proper termination
- Receptacle openings feature a beveled “lead-in” environmental regulations

## TARGET MARKETS / APPLICATIONS

- Appliances and White goods
- Membrane Switches and Electronic Displays
- Industrial and Instrumentation
- Medical
- POS equipment
- Hand-held terminals

## CLINCHER™ RECEPTACLES

### RECEPTACLE STANDARD SERIES 65801

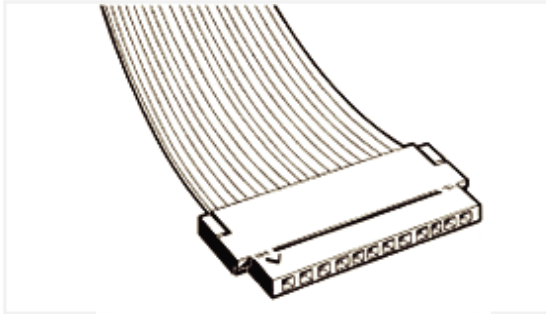

- Positions available: 2 through 32
- Plating Options: Gold/GXT or lead-free pure tin
- Mates best with: Clincher Pin Connectors Series 66226 or FCI Mini-latch pin connectors or BergStik™ / equivalent .025in. sq. posted. 0.100in. pitch un-shrouded headers
- For part numbers and technical information, search on: Base part number 65801

### RECEPTACLE OUTSIDE BAR POLARIZED WITH PASSIVE LATCHING SERIES 67516

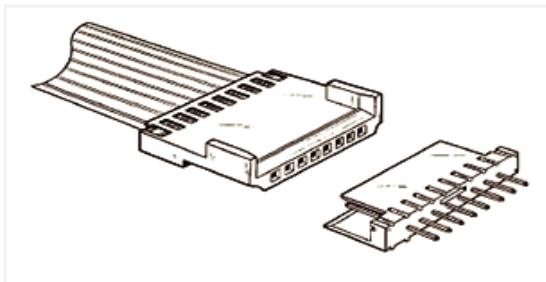

- Positions available: 2 through 16
- Plating Options: Gold/GXT or lead-free pure tin
- Mates best with: Clincher PCB Pin Headers Series 95735, 95736
- For part numbers and technical information, search on: Base part number 67516

### RECEPTACLE INSIDE BAR POLARIZED SERIES 10027313

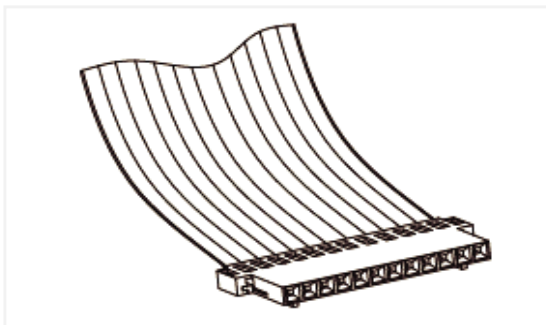

- Positions available: 6 through 34
- Plating Options: Gold/GXT or lead-free pure tin
- Mates best with industry standard PCB Pin connectors or BergStik™ / equivalent .025in. sq. posted, 0.100in. pitch un-shrouded headers
- For part numbers and technical information, search on: Base part number 10027313

### RECEPTACLE INSIDE BAR POLARIZED WITH LATCHING SERIES 10022753



- Positions available: 6 through 34
- Plating Options: Gold/GXT or lead-free pure tin
- Mates best with industry standard PCB Pin connectors
- For part numbers and technical information, search on: Base part number 10022753

## CLINCHER™ PIN CONNECTORS

### RECEPTACLE STANDARD SERIES 65801

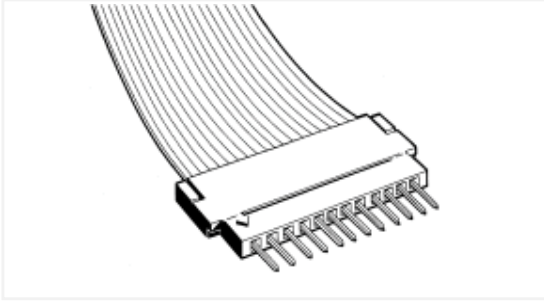

- Positions available: 3 through 14
- Plating Options: Gold/GXT or lead-free pure tin
- Mates best with: Clincher™ Receptacle, Standard Series 65801; FCI Mini-latch/Mini-PV™ Connectors
- For part numbers and technical information, search on: Base part number 66226

### RECEPTACLE OUTSIDE BAR POLARIZED WITH PASSIVE LATCHING SERIES 67516

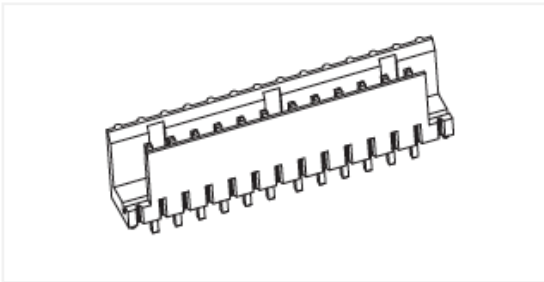

- Positions available: 2 through 16
- Plating Options: Gold/GXT or lead-free pure tin
- Mates best with Clincher™ Receptacle, Outside-bar polarized with Passive Latching Series 67516
- For part numbers and technical information, search on: Base part number 95735

### RECEPTACLE INSIDE BAR POLARIZED SERIES 10027313

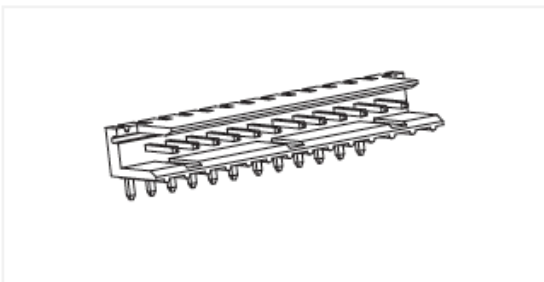

- Positions available: 2 through 16
- Plating Options: Gold/GXT or lead-free pure tin
- Mates best with Clincher™ Receptacle, Outside-bar polarized with Passive Latching Series 67516
- For part numbers and technical information, search on: Base part number 95736

## TECHNICAL INFORMATION

### MATERIALS

- Housings: Polypropylene UL 94 V-0, Blue
- Contact body base metal: Receptacles: Cupro-nickel; Pin Headers: Phosphor Bronze
- Contact spring base metal: Beryllium Copper
- Plating, contact spring: 3u Gold/GXT or 10u lead-free

### ELECTRICAL PERFORMANCE

- Contact resistance (LLCR) main contacts: 10 mΩ max; 20 mΩ max after environmental exposure
- Insulation Resistance: 5000 MΩ min
- Withstanding voltage: 1000 VAC RMS
- Current Rating: 2.0 amp continuous per contact

### MECHANICAL PERFORMANCE

- Mating and Un-mating force: 300 grams max per contact (does not include latching force)
- Latch retention: 4 lbs minimum
- Contact retention: 30 grams min per contact
- Cable retention: 10 lbs per inch of cable width.
- Contact durability: 100 mating cycles

### SPECIFICATIONS

- Cable
  - Specification: IPC Standard, FC-220 B Cables type A or B, tolerance class IV
  - Cable thickness: 0.33mm (0.013in.) max including insulation
  - Insulation material: Mylar® or KAPTON® Polyimide
  - Conductor thickness: 0.076 +/- 0.013mm (0.003 +/- 0.0005 in) 305 gr/m<sup>2</sup>
  - Conductor width: 1.57 +/- 0.07mm (0.062 +/- 0.0003 in)
  - Additional Cable Specifications: See technical drawings: TA-264, TA-371
  - Product Specification: BUS-12-021, BUS-12-022

### PACKAGING

- Anti-static Trays

### APPLICATION DATA

- TA-372, TA-264, TA-371

# **CLINCHER™ CONNECTOR SYSTEM FOR FLEXIBLE**

## **APPLICATION TOOLING**

### **PV-219E Semi-Automatic Application Machine**

- For mass-terminating both pin and receptacle Clincher connectors to flat flexible circuitry or flat conductor flat cable
- Bench model
- Pneumatically operated
- Tooling is adjustable for single-row housing sizes
- Quick changeover for different housing sizes
- Tooling is adjustable for single-row housing sizes
- Microprocessor controlled
- Machine PN 166652-001



### **HT-0274 Hand Tool**

- For terminating certain pin or receptacle Clincher connectors to flat flexible circuitry or flat conductor cable
- Terminates at all positions
- Terminates 67516 series only
- Lightweight and rugged
- Simple to operate
- Lightweight and rugged
- Tool PN HT-0274



### **HT 270 Hand Tool**

- For terminating certain pin or receptacle Clincher connectors to flat flexible circuitry or flat conductor cable
- Terminates 2, 3, or 4 positions at one time
- Ratchet handle assures complete crimp cycle
- Lightweight and rugged
- Simple to operate
- Lightweight and rugged
- Tool PN HT 270



FFCLINCHER0613EA4