

Features

- LO 2 TO 18 GHz
- RF 2 TO 18 GHz
- IF 0 TO 1000 MHz
- LO DRIVE: +7 dBm (NOMINAL)
- DC COUPLED I-PORT
- WIDE BANDWIDTH

Description

The MY85 is a double balanced mixer, designed for use in military, commercial and test equipment applications. The design utilizes Schottky ring quad diodes and broadband soft dielectric baluns to attain excellent performance. This mixer can also be used as a phase detector and/or bi-phase modulator since the IF port is DC coupled to the diodes. The use of high temperature solder and welded assembly processes used internally makes it ideal for use in manual, semi-automated assembly. Environmental screening available to MIL-STD-883, MIL-STD-202, or

Product Image

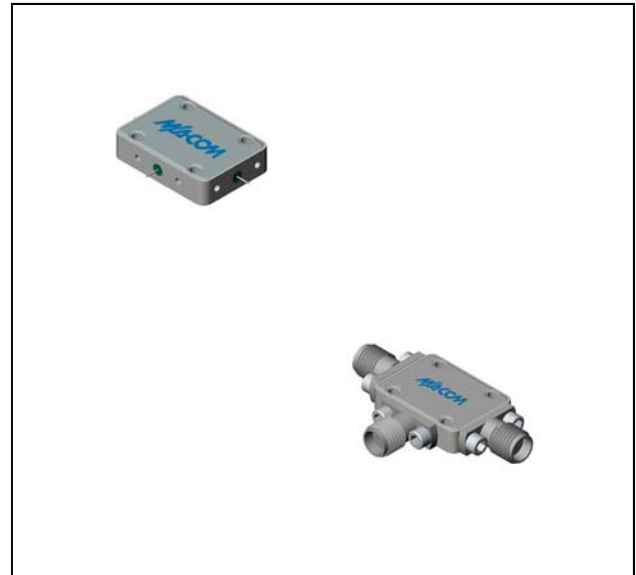

Ordering Information

Part Number	Package
MY85	Versapac
MY85C	SMA Connectorized

Electrical Specifications: $Z_0 = 50\Omega$ $Lo = +7$ dBm (Downconverter application only)

Parameter	Test Conditions	Units	Typical	Guaranteed	
				+25°C	-54° to +85°C
SSB Conversion Loss (max) & SSB Noise Figure (max)	fR = 4 to 14 GHz, fL = 3 to 15 GHz, fI = 0 to 1 GHz	dB	7.0	9.0	9.5
	fR = 2 to 3 GHz, fL = 2 to 3 GHz, fI = 0 to 1 GHz	dB	10.0	11.0	11.5
	fR = 3 to 18 GHz, fL = 3 to 18 GHz, fI = 0 to 1 GHz	dB	8.5	10.5	11.0
Isolation, L to R (min)	fL = 2 to 18 GHz	dB	35	22	20
Isolation, L to I (min)	fL = 2 to 18 GHz	dB	20	15	13
1 dB Conversion Comp.	fL = +7 dBm	dBm	+1		
Input IP3	fR1 =5 GHz at -10 dBm, fR2 = 5.01 GHz at -10 dBm, fL = 5.5 GHz at +7 dBm	dBm	+10		
	fR1=15 GHz at -10 dBm, fR2=15.01GHz at -10 dBm, fL = 14.5 GHz at +7 dBm	dBm	+10		

Typical Performance Curves

Conversion Loss vs LO Power Level

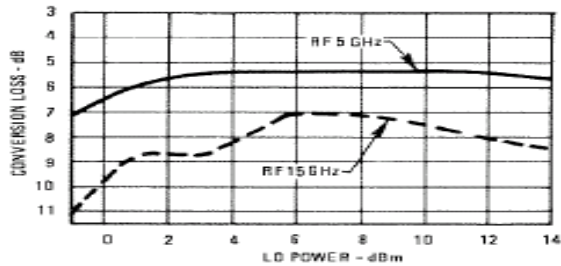

Up Conversion Loss

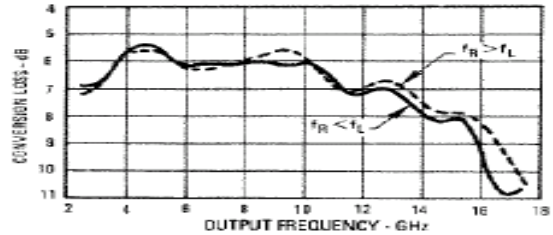

Conversion Loss

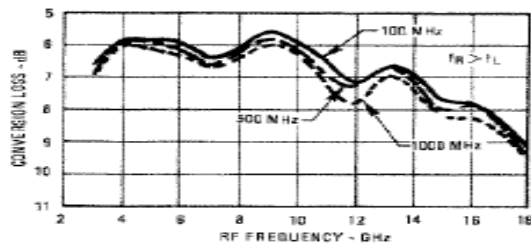

Isolation

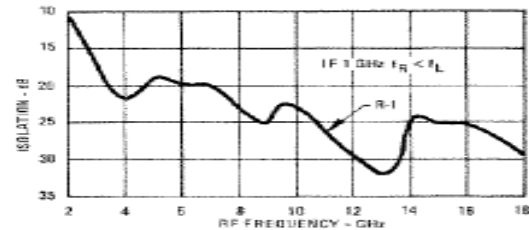
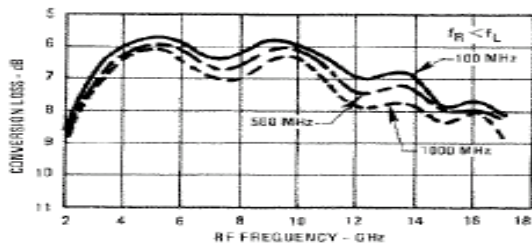
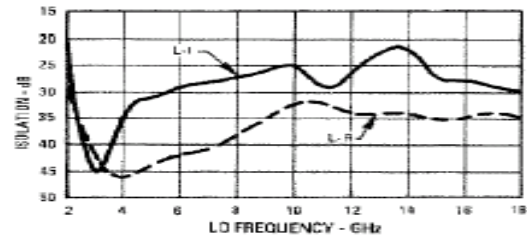

Conversion Loss over Temperature

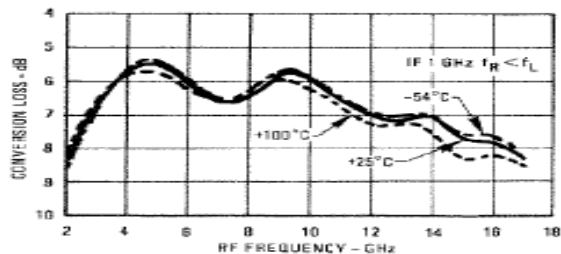

I Port Bandwidth

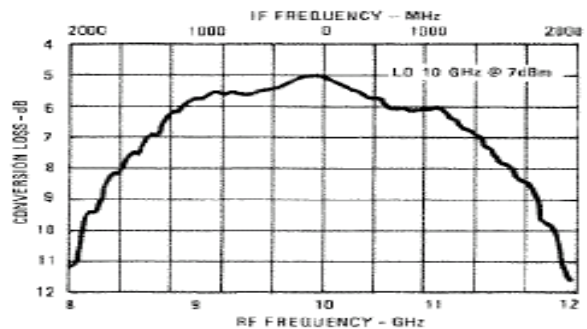

Absolute Maximum Ratings

Parameter	Absolute Maximum
Operating Temperature	-54°C to +100°C
Storage Temperature	-65°C to +100°C
Peak Input Power	+23 dBm max @ +25°C +20 dBm max @ +100°C
Peak Input Current	100 mA DC

Outline Drawing: Versapac *

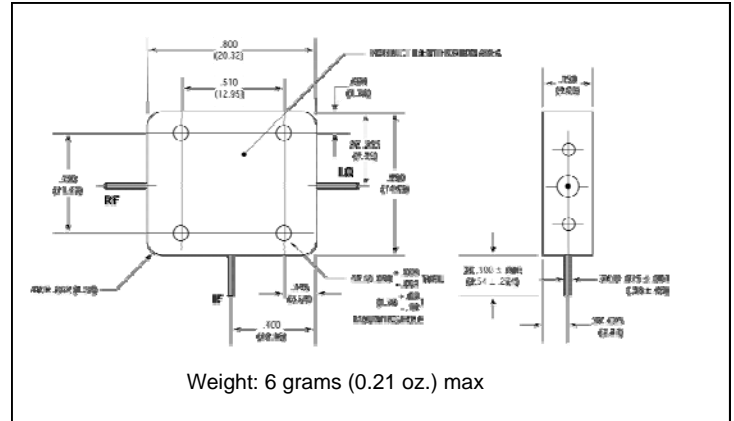

Outline Drawing: SMA Connectorized *

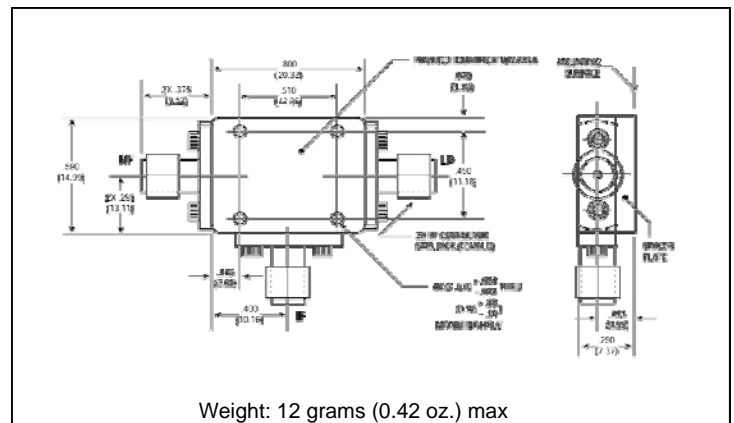

Insertion Loss with DC Driven I-Port

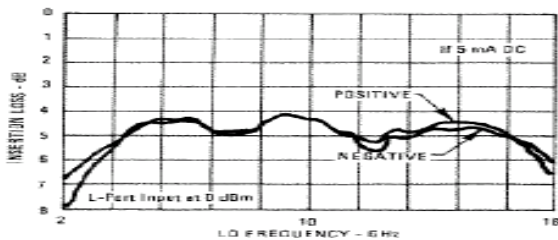
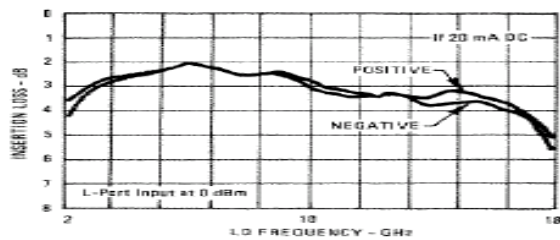

VSWR

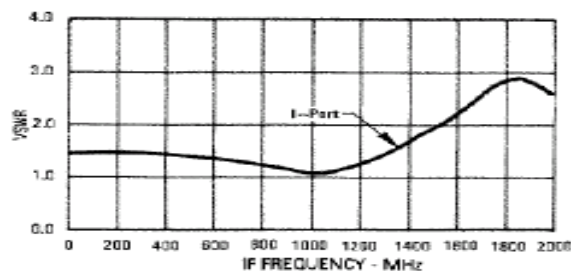
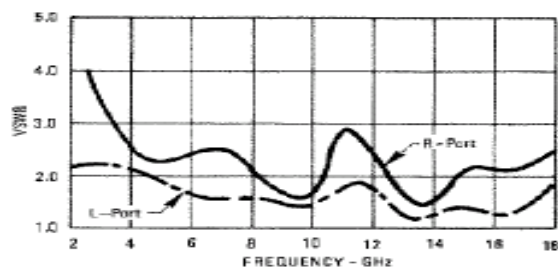

* Dimensions are inches (millimeters) ±0.015 (0.38) unless otherwise specified.