



User Manual

ARK-1388V

Fanless Embedded Box IPC

Trusted ePlatform Services

ADVANTECH

Copyright

The documentation and the software included with this product are copyrighted 2009 by Advantech Co., Ltd. All rights are reserved. Advantech Co., Ltd. reserves the right to make improvements in the products described in this manual at any time without notice.

No part of this manual may be reproduced, copied, translated or transmitted in any form or by any means without the prior written permission of Advantech Co., Ltd. Information provided in this manual is intended to be accurate and reliable. However, Advantech Co., Ltd. assumes no responsibility for its use, nor for any infringements of the rights of third parties, which may result from its use.

Acknowledgements

Award is a trademark of Award Software International, Inc.

VIA is a trademark of VIA Technologies, Inc.

IBM, PC/AT, PS/2 and VGA are trademarks of International Business Machines Corporation.

Intel® and Pentium® are trademarks of Intel Corporation.

Microsoft Windows® is a registered trademark of Microsoft Corp.

RTL is a trademark of Realtek Semi-Conductor Co., Ltd.

ESS is a trademark of ESS Technology, Inc.

UMC is a trademark of United Microelectronics Corporation.

SMI is a trademark of Silicon Motion, Inc.

Creative is a trademark of Creative Technology LTD.

CHRONTEL is a trademark of Chrontel Inc.

All other product names or trademarks are properties of their respective owners.

For more information about this and other Advantech products, please visit our website at:

<http://www.advantech.com/>

<http://www.advantech.com/ePlatform/>

For technical support and service, please visit our support website at:

<http://support.advantech.com.tw/support/>

Product Warranty (2 years)

Advantech warrants to you, the original purchaser, that each of its products will be free from defects in materials and workmanship for two years from the date of purchase.

This warranty does not apply to any products which have been repaired or altered by persons other than repair personnel authorized by Advantech, or which have been subject to misuse, abuse, accident or improper installation. Advantech assumes no liability under the terms of this warranty as a consequence of such events.

Because of Advantech's high quality-control standards and rigorous testing, most of our customers never need to use our repair service. If an Advantech product is defective, it will be repaired or replaced at no charge during the warranty period. For out-of-warranty repairs, you will be billed according to the cost of replacement materials, service time and freight. Please consult your dealer for more details.

If you think you have a defective product, follow these steps:

1. Collect all the information about the problem encountered. (For example, CPU speed, Advantech products used, other hardware and software used, etc.) Note anything abnormal and list any onscreen messages you get when the problem occurs.
2. Call your dealer and describe the problem. Please have your manual, product, and any helpful information readily available.
3. If your product is diagnosed as defective, obtain an RMA (return merchandise authorization) number from your dealer. This allows us to process your return more quickly.
4. Carefully pack the defective product, a fully-completed Repair and Replacement Order Card and a photocopy proof of purchase date (such as your sales receipt) in a shippable container. A product returned without proof of the purchase date is not eligible for warranty service.
5. Write the RMA number visibly on the outside of the package and ship it prepaid to your dealer.

Technical Support and Assistance

1. Visit the Advantech web site at www.advantech.com/support where you can find the latest information about the product.
2. Contact your distributor, sales representative, or Advantech's customer service center for technical support if you need additional assistance. Please have the following information ready before you call:
 - Product name and serial number
 - Description of your peripheral attachments
 - Description of your software (operating system, version, application software, etc.)
 - A complete description of the problem
 - The exact wording of any error messages

Warnings, Cautions and Notes

Warning! Warnings indicate conditions that, if left uncorrected, can cause personal injury!



Caution! Cautions are included to help you avoid damaging hardware or losing data. e.g., there is a danger of a new battery exploding if it is incorrectly installed. Do not attempt to recharge, force open, or heat the battery. Replace the battery only with the same or equivalent type recommended by the manufacturer.



Discard used batteries according to the manufacturer's instructions.

Note! Notes provide optional additional information.



Packing List

Before installation, please ensure the following items have been shipped:

- 1 ARK-1388V unit
- 1 Utility CD with English manual
- 1 Registration and 1 year Warranty card Rev. A
- 1 3-Pole Phoenix to DC-Jack Power Cable 1700012555
- 1 D-SUB 26p connector to 3 x serial ports cable 1700012535
- 1 D-SUB 9p to phoenix 10pin DIO cable 1700012536
- 1 GPS Antenna 5V x 5M 1750001782
- 1 Simplified Chinese user manual 2006138810
- 1 China RoHS Electronic Pollution ARK-1388V 1st 2026138800

Ordering information

Model Number	Description
ARK-1388V-S0A1E	Intel Celeron M ULV423 1.06GHz, onboard GPS, VGA/LVDS, COM, USB, DIO In vehicle Box IPC
ARK-1388V-S1A1E	Intel Core2Duo U7500 1.06GHz, onboard GPS, VGA/LVDS, COM, USB, DIO In vehicle Box IPC

Optional accessories

1652000295	3P Phoenix Power PLUG-IN BLOCK
1757002682	AC-to-DC Adapter DC19 V/3.42 A 65 W, 0 ~ 40°C for Home and Office Use
1700001524	Power Cable 3-pin 180 cm, USA type, Thailand, Philippines
170203183C	Power Cable 3-pin 180 cm, Europe Type, Indonesia
170203180A	Power Cable 3-pin 180 cm, UK Type, Singapore, Malaysia
9666K10000E	DIN-Rail mounting kit for ARK-1000 series model
9666K10001E	VESA mounting kit for ARK-1000 series model
9796138800E (AMO-EDGE)	AMO-Q2687 GSM/GPRS/EDGE module, include one Antenna 5 Band 850/900/1800/1900/2100 SMA.M 10.8cm (1750004421)
9796138801E (AMO-HSDPA)	AMO-HC25 UMTS/HSDPA module, include one Antenna 4 Band 850/900/1800/1900 SMA.M 8.3cm (1750002840)
1750003222	WLAN 802.11b/g 5dBi Dipole Antenna
968EMW0016	PURCH 802.11b/g Mini-PCI card

Contents

Chapter 1 General Introduction1

1.1	Introduction	2
1.2	Product Feature	3
1.3	Chipset	4
1.3.1	Functional Specification	4
1.3.2	Mechanical Specifications	7
	Figure 1.1 ARK-1388V dimensions	7
1.3.3	Electrical Specification	8
1.4	Environmental Specifications	8
1.4.1	Operating temperature	8
1.4.2	Operating Humidity	8
1.4.3	Storage Temperature	8
1.4.4	Storage Humidity	8

Chapter 2 H/W installation.....9

2.1	Jumpers	10
2.1.1	Jumper Description	10
2.1.2	Jumper List	11
	Table 2.1: Jumper List	11
2.1.3	Jumper Settings	11
	Table 2.2: CN18 Power system selection.....	11
	Table 2.3: J1 LVDS Voltage Setting	11
	Table 2.4: JP3 CLEAR CMOS	11
	Table 2.5: SW2 COM1 RS232/422/485 Select	12
	Table 2.6: SW3 COM1 and COM3 RS232/422/485 Select	12
	Table 2.7: SW6-1,2,3 COM2 RS232/422/485 Select	12
	Table 2.8: SW6-4,5,6 Vehicle OFFDELAY / HARDOFF Setting	13
	Table 2.9: SW5 COM2 RS232/422/485 Select	13
	Table 2.10: SW4 COM3 RS232/422/485 Select	13
2.1.4	Locating Jumpers on the Board	14
	Figure 2.1 Locating Jumpers on the Board-Top side.....	14
	Figure 2.2 Locating Jumpers on the Board-Bottom side	14
2.2	Connectors	15
2.2.1	Connector position	15
	Figure 2.3 ARK-1388V Front I/O Panel	15
	Figure 2.4 ARK-1388V Rear I/O Panel	15
2.2.2	ARK-1388V front side external I/O connectors	16
	Figure 2.5 USB connector	16
	Table 2.11: USB Connector	16
	Figure 2.6 VGA connector	16
	Table 2.12: VGA connector pin assignments	16
	Figure 2.7 LVDS Connector.....	17
	Table 2.13: LVDS Connector Pin Assignments	17
	Figure 2.8 BNC Connector	18
	Table 2.14: Left Line Out pin assignments	18
	Table 2.15: Right Line Out pin assignments.....	18
	Figure 2.9 phone Jack Connector.....	18
	Table 2.16: Mic in pin assignments	18
2.2.3	ARK-1388V rear side external I/O connectors	19
	Figure 2.10 Ethernet connector	19
	Table 2.17: RJ-45 Connector pin assignments	19
	Figure 2.11 DIO connector	20
	Table 2.18: DIO cable pin color to DIO pin assignments.....	20

Figure 2.12DIO cable	20
Table 2.19:DIO port pin assignments.....	20
Figure 2.13COM connector	21
Table 2.20: COM standard serial port pin assignments	21
Table 2.21:D-SUB CONN 26P pin assignments	22
Figure 2.14COM2~4 cable	23
Figure 2.15Power Input Connector.....	23
Table 2.22: Power connector pin assignments	23

Chapter 3 BIOS Settings 25

3.1	BIOS Introduction.....	26
3.2	BIOS Setup	26
3.2.1	Main Menu	27
3.2.2	Standard CMOS Features	28
3.2.3	Advanced BIOS Features	29
3.2.4	Advanced Chipset Features	32
3.2.5	Integrated Peripherals	34
3.2.6	Power Management Setup	37
3.2.7	PnP/PCI Configurations.....	40
3.2.8	PC Health Status	41
3.2.9	Frequency/Voltage Control.....	42
3.2.10	Load Optimized Defaults	43
3.2.11	Set Password.....	44
3.2.12	Save & Exit Setup.....	45
3.2.13	Quit Without Saving.....	46

Chapter 4 In-vehicle power setting 47

4.1	Power mode selection.....	48
	Figure 4.1 The jumper location for power mode selection (CN18)	48
4.2	Turn on procedure of PIC firmware.....	49
	Figure 4.2 Turn on procedure of PIC firmware	49
4.3	Turn off procedure of PIC firmware.....	49
	Figure 4.3 Turn off procedure of PIC firmware	49
	Figure 4.4 The switch location for off delay and hard off setting (SW6)	50
4.4	Battery Status Checking	50
	Figure 4.5 Battery status checking of PIC firmware	50

Chapter 5 Extension I/O Installation 51

5.1	AMO-Module.....	52
5.1.1	AMO-EDGE (9796138800E)	52
	Table 5.1: AMO-EDGE connect list.....	52
	Figure 5.1 AMO-EDGE base board.....	52
	Figure 5.2 Install Wavecom module on AMO base board	53
	Figure 5.3 AMO-EDGE base board and wavecom module.....	53
	Figure 5.4 GPRS/EDGE SMA cable internally	53
	Figure 5.5 Wavecom UFL/SMA connector	54
	Figure 5.6 Mounting wavecom on AMO base board	54
	Figure 5.7 Installation AMO-EDGE on ARK-1388V.....	55
5.1.2	AMO-HSDPA (9796138801E)	55
	Table 5.2: AMO-HSDPA connect list.....	55
	Figure 5.8 AMO-HSDPA board	55
	Figure 5.9 install Siemens module on AMO board	56
	Figure 5.10AMO-EDGE base board and Siemens module	56

Figure 5.11 UMTS/HSDPA SMA cable internally	56
Figure 5.12 Siemens antenna connector	57
Figure 5.13 Installation AMO-HSDPA on ARK-1388V	57

Chapter 6 Full Disassembly Procedure59

6.1 Full disassembly procedure	60
6.2 Full assembly procedure	65

Appendix A GPS test Setting Guide71

A.1 GPS test Setting Guide	72
----------------------------------	----

Appendix B AMO-EDGE GPRS Module (Q2687) Board Settings77

B.1 AMO-EDGE GPRS Module (Q2687) Board Setting.....	78
-----------------------------------------------------	----

Appendix C AMO-HSDPA GPRS Module (HC25) Setting Guide89

C.1 AMO-HSDPA GPRS Module (HC25) Setting Guide	90
------------------------------------------------------	----

Chapter 1

General Introduction

1.1 Introduction

ARK-1388V is a fanless embedded box IPC with focus on in-vehicle computing systems, which are frequently required to perform under very stringent power requirements. These include load-dump, cold-crank, very low power consumption at light loads, and low-noise operation. Additionally, these solutions are generally required to be very compact and thermally efficient.

The dimensions of the ARK-1388V are 18.9 x 6.38 x 1.31 cm, and it weighs only 1.76 kg. ARK-1388V delivers excellent computing and multi-media performance with an Intel® Core™2 Duo ULV U7500 1.06 GHz / Celeron® M ULV 1.06 GHz processor and an Intel® 945GM/GME chipset. And with the efficient thermal design, the operating temperatures run from -20 to 60°C. It supports a rich I/O interface, including four serial ports, LVDS and VGA dual independent display, 4 x USBs, 1 x LAN, DIO with isolation and relay function, and amplified audio line-out, plus safe boot and safe shutdown functions. ARK-1388V is the best choice for in-vehicle solutions in trucks, buses, wagons, taxis and trains.

Smart Power Control

Due to the demands of the in-vehicle power environment, the ARK-1388V box IPC works with both 12-volt and 24-volt systems, and is designed with safe boot and safe shutdown to offer safe and stable solutions. The design incorporates hardware power protection and smart software monitor and control features. The ARK-1388V may be powered with DC input from 9 to 32 VDC, and supports a minimum of 6VDC ISO-7637-2 cold crank and load dump. Advantech also includes a utility that allows the SI and/or the customer to adjust their power voltage, delay on/off timings, and save and load presets. In addition, the rugged, fanless aluminum case provides passive cooling for extra quiet operation. The system also offers excellent shock and vibration protection, easily passing 50 and 5 Grms shock and vibration tests.

In-vehicle Wireless Life

Today, entertainment and wireless navigation functions are fast becoming customary, if not mandatory, and more and more applications require in-vehicle computing systems. ARK-1388V box IPC is equipped with an 802.11b/g WLAN card, a built in GPS receiver which supports 50 channels, GPRS support, 3.5G antenna, and supports VGA and LVDS dual independent display mode for multi-media applications. Optional GPRS/EDGE/UMTS/HSDPA modules can easily be interchanged. In-vehicle applications can be expected to become both more convenient and more interesting in the very near future.

1.2 Product Feature

General

- **CPU:** Intel Core2Duo ULV U7500 at 1.06GHz/ Celeron M ULV 423 at 1.06GHz
- **System Chipset:** 945GM/GME chipset 533 MHz FSB
- **BIOS:** AWARD® 4 Mbit Flash BIOS
- **System Memory:** 200-pin SODIMM socket, support ECC Double Data Rate (DDR2) 128 MB to 1 GB, DDR2 533/667 MHz
- **Power Management:** APM1.2, ACPI 2.0 support
- **SSD:** Supports CompactFlash® Card TYPE I/II (shared 1st IDE Channel)
- **Watchdog Timer:** Single chip Watchdog 255-level interval timer, setup by software
- **Expansion Interface:** 1 x miniPCI (Equipped with miniPCI WLAN card for ARK-1382W version)
- **Battery:** 3V/210 mAh
- **I/O Interface:** 1 x RS-232, 3 x RS232/422/485 (COM1: default is RS-485, RS-422/485 by jumper setting, COM2~4: default is RS-232)
- **USB:** 4 x USB 2.0 compliant Ports
- **Audio:** ALC203 AC97 surround stereo sound and dual output 6W amplifier. Supports Spkr-out (Left and Right) and Mic-in
- **IrDA:** N/A
- **GPIO:** 6 bit; 4 x Digital input with isolation and 2 x Digital output with relay
- **LAN Chipset:** 82562GZ
- **Speed:** 10/100 Mbps
- **Interface:** 1 x RJ45
- **Standard:** IEEE 802.3u 100Base-T

Display

- **Chipset:** Integrated graphics built in to Intel 945GM/GME, Intel 3.5 Generation integrated Graphics Engine
- **Memory Size:** Supports Intel DVMT (Dynamic Video Memory Technology) 3.0 1 MB or 8 MB under system BIOS
- **Resolution:** CRT Display mode: pixel resolution up to 1600 x 1200 at 85-Hz and 1600 x 1200 at 75-Hz LCD Display mode:
- **Display Interface:** 1 x VGA, 1 x LVDS
- **Dual Independent:** VGA + LVDS

Communication

- **Wireless LAN:** 802.11b/g WLAN miniPCI module (optional)
- **GPS:** Built-in u-blox LEA 5 GPS GPS/GALILEO chip
- **GPRS/EDGE/HSDPA**
 - Wavecom Q2686, supports GSM/GPRS, 850/900/1800/1900MHz (optional)
 - Wavecom Q2687, supports GSM/GPRS/EDGE, 850/900/1800/1900MHz (optional)
 - Siemens HC25, supports UMTS/HSDPA Triple band, 850/1900/2100MHz and GSM/GPRS/EDGE: Quad band, 850/900/1800/1900MHz (optional)

1.3 Chipset

1.3.1 Functional Specification

1.3.1.1 Processor

Processor	<p>CPU support:</p> <ul style="list-style-type: none"> ■ Supports 533 MHz Source-Synchronous Processor System Bus. ■ Supports Intel Core2Duo ULV U7500 at 1.06GHz /Intel Celeron ULV423 at 1.06GHZ CPU. <p>35mm *35mm Micro-FCBGA Package.</p>
------------------	------------------------------------------------------------------------------------------------------------------------------------------------------------------------------------------------------------------------------------------------------------------------

For ARK-1388V-S0A1E,ARK-1388V-S1A1E

1.3.1.2 Chipset (CX700)

Host Interface	<ul style="list-style-type: none"> ■ YONAH processor, 90 nm process ■ 533/667 MHz FSB Support ■ 32-bit interface to address up to 4GB of memory
Memory	<p>NB: Intel 945GM/GME GMCH chip support</p> <p>Supports 533/667MHz DDR2 SDRAM devices with max 1GB DDR SDRAM. SO-DIMM Socket on board: 200 pin SO-DIMM socket type x 1</p> <p>* May have compatibility issue for 2GB memory; please check with Advantech support team.</p>
Graphic and Video Controllers	<p>NB: Intel 945GM/GME GMCH chip support</p> <ul style="list-style-type: none"> ■ Internal Graphics Features ■ Dual display choose on board: VGA + LVDS through OS Driver <p>CRT</p> <ul style="list-style-type: none"> - Integrated 400-MHz, Three 8-bit DACs provide the R,G and B signal to the monitor - Supports pixel resolution up to QXGA - Supports Display Hot Plug <p>LVDS</p> <ul style="list-style-type: none"> - Panel support up to UXGA (1600 x 1200) - 25MHz- 112MHz single-/dual-channel; @18 bpp –TFT panel type supported - Pixel Dithering for 18-bit TFT panel to emulate 24-bpp true color displays - supports 18/36bit LVDS <ul style="list-style-type: none"> ■ WinXP Extended desktop support for VGA+LVDS dual display ■ VGA Connector on board: D-SUB Conn. 15P 90D(F) DIP ■ LVDS connector by internal cable: D-SUB Conn, 26P

IDE Interface	<p>SB: Intel NH82801GHM chip support</p> <ul style="list-style-type: none"> ■ Supports PIO IDE transfers up to 16 Mbytes/sec ■ Supports Ultra ATA transfers to 100/66/33 Mbytes/sec. ■ The IDE interface integrates 16x32-bit buffers for optimal transfers. ■ Supports Compact Flash Card Type II Socket ■ CF Socket on board: CF Type II 50P 90D(M) external connector x 1
Mini PCI Interface	<p>SB: Intel NH82801GHM chip support</p> <ul style="list-style-type: none"> ■ Supports Mini PCI Interface 1.0 ■ Supports Mini PCI WLAN extension card use only ■ Supports 802.11A/B/G when use 9680005627 ■ Mini PCI socket: MINI PCI 124P 180D(F) SMD x 1
Power Management	<p>SB: Intel NH82801GHM chip support</p> <ul style="list-style-type: none"> ■ Supports ACPI 3.0 ■ ACPI Power Management Logic Support ■ Power connector: Plug-In block 2P DIP x 1
USB Interface	<p>SB: Intel NH82801GHM chip support</p> <ul style="list-style-type: none"> ■ USB host interface with support for 4 USB 2.0 ports ■ All ports are High-Speed, Full-Speed, and Low-Speed capable ■ Supports legacy keyboard/mouse software ■ USB dual connector on board: USB conn 8P 90D(M) DIP x 2
Audio Link	<p>SB: Intel NH82801GHM chip support</p> <ul style="list-style-type: none"> ■ Supports Audio Codec'97, Revision 2.3 specification ■ Supports Link for Audio and Telephony CODECS ■ Supports Dual 6W Audio Amplifier Plus Stereo ■ RCA Jack on Board: 3P 90D(F) Red x 1 (Line-out, Right Channel) ■ RCA Jack on Board: 3P 90D(F) White x 1 (Line-out, Left Channel) ■ PHONE JACK on Board: 5P 90D(F) Pink x 1 (Mic-in)
BIOS	<p>SB: Intel NH82801GHM chip support</p> <ul style="list-style-type: none"> ■ Low Pin Count (LPC) interface support ■ Firmware Hub (FWH) interface support ■ Phoenix 4M bit Flash BIOS, supports Plug & Play, APM 1.2/ACPI 1.1. ■ Socket: 32 pin PLCC socket x 1

1.3.1.3 Other

<p>Serial ports</p>	<p>Super I/O: SMSC SCH3106</p> <ul style="list-style-type: none"> ■ 4 full-function serial ports by SMSC SCH3106. ■ Supports IRQ Sharing among serial ports on XPE COM1: Supports to RS-232/422/485 and setting by Jumper, default RS-485 ■ COM2~4: COM2~3 support RS-232/422/485 by jumper setting, COM4 supports only RS-232, default is RS-232. ■ COM1 connector: D-SUB CON. 9P 90D(M)DIP x 1 ■ COM2~4 connector: D-SUB CON. 26P, by cable 1700012535 to connect 3 x D-SUB CON. 9P 90D(M)DIP. <p>** RS-485 support Auto flow control.</p>
<p>Thermal sensor</p>	<p>Super I/O: Winbond W83627HG supports.</p> <ul style="list-style-type: none"> ■ Monitor the current CPU temperature ■ Monitor the main power voltage
<p>LAN</p>	<p>LAN Chip: Intel 82562GZ supports</p> <ul style="list-style-type: none"> ■ Supports PCI 1.0a ■ Integrated 10/100 transceiver ■ Fully compliant with IEEE 802.3 compliant ■ Supports Wake on LAN and remote wake-up ■ Giga LAN connector on Board: Phone Jack RJ45 8P8C 90D W/LED
<p>Battery backup</p>	<p>Battery support: CR2032</p> <ul style="list-style-type: none"> ■ BATTERY 3V/210 mAh with WIRE x 1
<p>GPS</p>	<p>GPS: u-blox LEA-5 GPS/GALILEO chip</p> <ul style="list-style-type: none"> ■ Fast acquisition, even in weak signal conditions ■ Down to -160 dBm acq. and tracking sensitivity ■ 1 second time to first fix ■ 50 channels, 1 million correlators ■ bundles with GPS 5M antenna
<p>WLAN (Optional)</p>	<p>Wireless LAN Module Card: WM3210</p> <p>Supports Mini PCI Interface 1.0 Supports 802.11 b / g Mini PCI socket: MINI PCI 124P 180D(F) SMD x 1</p>
<p>GSM/GPRS/EDGE</p>	<p>GSM/GPRS/EDGE module: Wavecom Q2687 (AMO-EDGE)</p> <ul style="list-style-type: none"> ■ Quad band: GSM/GPRS/EDGE: 900/1800/850/1900 MHz ■ Enhanced Data rates for GSM Evolution (EDGE) ■ Bundle with 850/900/1800/1900 MHz antenna

UMTS/HSDPA	UMTS/HSDPA module: Siemens HC25 (AMO-HSDPA)
	<ul style="list-style-type: none"> ■ UMTS/HSDPA: Triple band, 850/1900/2100MHz ■ GSM/GPRS/EDGE: Quad band, 850/900/1800/1900MHz ■ HSDPA support data rate up to 3.6 Mbps ■ Operating temperature: -20~+85°C ■ Bundles with 850 / 900 / 1800 / 1900 / 2100MHz antenna

1.3.2 Mechanical Specifications

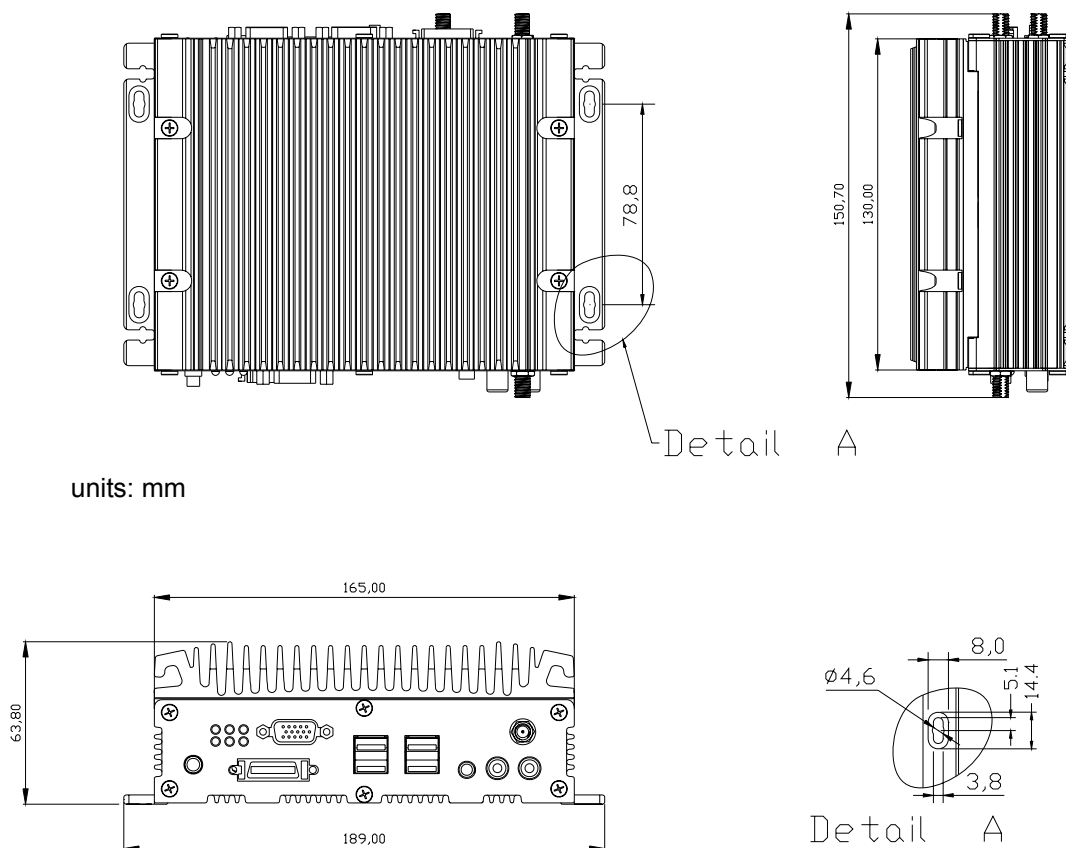

Figure 1.1 ARK-1388V dimensions

1.3.2.1 Dimensions

189 x 63.76 x 130.6 mm (7.44" x 2.41" x 5.14")

1.3.2.2 Weight with Heatsink

1.79 kg

1.3.3 Electrical Specification

1.3.3.1 Power supply Voltage

Voltage requirement with Adaptor:

9 V @ 5.11 A, 12 V @ 3.84 A, 19 V @ 2.42 A, 35 V @ 1.32 A

1.3.3.2 Power supply Current

Supply Current (Maximum)

CPU: Intel Celeron ULV423 1.06, RAM:533MHz 512GB DDR2 SDRAM

Adaptor	19V
Dos	0.86A
WINXP Idle	0.88A
WINXP BURN IN TEST	1.16A
Suspend	0.66A

1.3.3.3 RTC Battery

Nominal Voltage: 3.0 V

Nominal discharge capacity: 210 mAh

1.4 Environmental Specifications

1.4.1 Operating temperature

The Intel® Celeron® is specified for proper operation when the junction temperature is within the specified range of 0°C to 100°C.

The Intel® 945GM/GME chipset temperature runs at a maximum of 105°C. The Intel® ICH7-M I/O Controller Hub 4 (82801) case temperature runs at a maximum of 99°C.

The processor protects itself from catastrophic overheating by use of an internal thermal sensor at a temperature level of approximately 135°C.

Operating temperature: ARK-1388V-S0A1E: -20 ~ 60°C (-4 ~ 140°F)

ARK-1388V-S1A1E: -20 ~ 55°C (-4 ~ 131°F)

1.4.2 Operating Humidity

Operating Humidity: 0% ~ 90% Relative Humidity, non-condensing

1.4.3 Storage Temperature

Standard products (0~60°C)

Storage temperature: -40~85°C

1.4.4 Storage Humidity

Standard products (0~60°C)

Relative humidity: 95% @ 60°C

Chapter 2

H/W installation

2.1 Jumpers

2.1.1 Jumper Description

Cards can be configured by setting jumpers. A jumper is a metal bridge used to close an electric circuit. It consists of two metal pins and a small metal clip (often protected by a plastic cover) that slides over the pins to connect them. To close a jumper, you connect the pins with the clip. To open a jumper, you remove the clip. Sometimes a jumper will have three pins, labeled 1, 2 and 3. In this case you would connect either pins 1 and 2, or 2 and 3.

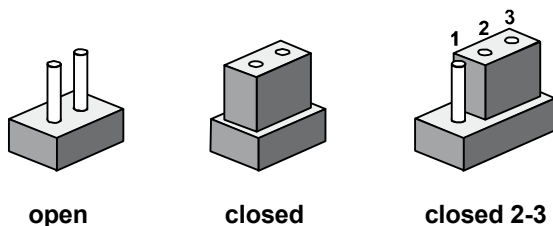

The jumper settings are schematically depicted in this manual as follows.

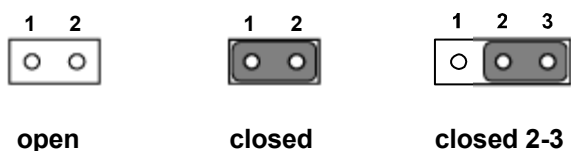

A pair of needle-nose pliers may be helpful when working with jumpers. If you have any doubts about the best hardware configuration for your application, contact your local distributor or sales representative before you make any changes. Generally, you simply need a standard cable to make most connections.

Warning! *To avoid damaging the computer, always turn off the power supply before setting jumpers or clearing CMOS. Before turning on the power supply, make sure CMOS jumper is set back to normal.*



2.1.2 Jumper List

Table 2.1: Jumper List

CN18	Power Mode Setting
J1	LVDS Voltage Setting
JP3	Clear CMOS Setting
SW2	COM1 RS232 / 422 / 485 Setting
SW3	COM1 and COM3 RS232 / 422 / 485 Setting
SW4	COM3 RS232 / 422 / 485 Setting
SW5	COM2 RS232 / 422 / 485 Setting
SW6	COM2 RS232 / 422 / 485 Setting, Vehicle OFFDELAY / HARDOFF Setting

2.1.3 Jumper Settings

Table 2.2: CN18 Power system selection

Part Number	1653002101
Footprint	JH2X1V-2M
Description	PIN HEADER 2*1P 180D(M)SQUARE 2.0mm DIP W/O Pb
Setting	Function
OPEN (NL)	Vehicle Power
CLOSE	ATX Power (default)

Table 2.3: J1 LVDS Voltage Setting

Part Number	1653003101
Footprint	JH3X1V-2M
Description	PIN HEADER 3*1P 180D(M) 2.0mm DIP SQUARE W/O Pb
Setting	Function
1-2	5 V (Default)
2-3	3.3 V

Table 2.4: JP3 CLEAR CMOS

Part Number	1653003100
Footprint	JH3X1V
Description	PIN HEADER 3*1P 180D(M) 2.54mm DIP WO/Pb
Setting	Function
(1-2)	CLEAR CMOS
(2-3)	NORMAL (Default)

Table 2.5: SW2 COM1 RS232/422/485 Select

Part Number	1600000802
Footprint	SW_8x2P_50_461x315
Description	DIP SW SMD 16P SPST P=1.27mm W=5.4mm IC Type
Setting	Function
1,3,5,7 ON ; 2,4,6,8 OFF	RS232
2,4,6,8 ON ; 1,3,5,7 OFF	RS422
2,4,6,8 ON ; 1,3,5,7 OFF	RS485

Table 2.6: SW3 COM1 and COM3 RS232/422/485 Select

Part Number	1600000602
Footprint	SW_6x2P_50_362x315
Description	SW SMD 12P P=1.27mm W=5.8mm 218-006LPST-R CTS
Setting	Function
1 ON ; 2,3 OFF	RS485 for COM1
2 ON ; 1,3 OFF	RS422 for COM1
3 ON ; 1,2 OFF	RS232 for COM1
4 ON ; 5,6 OFF	RS485 for COM3
5 ON ; 4,6 OFF	RS422 for COM3
6 ON ; 4,5 OFF	RS232 for COM3

Table 2.7: SW6-1,2,3 COM2 RS232/422/485 Select

Part Number	1600000602
Footprint	SW_6x2P_50_362x315
Description	SW SMD 12P P=1.27mm W=5.8mm 218-006LPST-R CTS
Setting	Function
1 ON ; 2,3 OFF	RS485
2 ON ; 1,3 OFF	RS422
3 ON ; 1,2 OFF	RS232

Table 2.8: SW6-4,5,6 Vehicle OFFDELAY / HARDOFF Setting

Part Number	1600000802
Footprint	SW_8x2P_50_461x315
Description	DIP SW SMD 16P SPST P=1.27mm W=5.4mm IC Type
Setting (6,5,4)	Function
ON; ON; ON	60S, 180S (Default)
ON; ON; OFF	120S, 180S
ON; OFF; ON;	180S, 180S
ON; OFF; OFF	240S, 180S
OFF; ON; ON;	300S, 180S
OFF; ON; OFF	360S, 180S
OFF; OFF; ON	420S, 180S
OFF; OFF; OFF	Never, Never

Table 2.9: SW5 COM2 RS232/422/485 Select

Part Number	1600000802
Footprint	SW_8x2P_50_461x315
Description	DIP SW SMD 16P SPST P=1.27mm W=5.4mm IC Type
Setting	Function
1,3,5,7 ON ; 2,4,6,8 OFF	RS232
2,4,6,8 ON ; 1,3,5,7 OFF	RS422
2,4,6,8 ON ; 1,3,5,7 OFF	RS485

Table 2.10: SW4 COM3 RS232/422/485 Select

Part Number	1600000802
Footprint	SW_8x2P_50_461x315
Description	DIP SW SMD 16P SPST P=1.27mm W=5.4mm IC Type
Setting	Function
1,3,5,7 ON ; 2,4,6,8 OFF	RS232
2,4,6,8 ON ; 1,3,5,7 OFF	RS422
2,4,6,8 ON ; 1,3,5,7 OFF	RS485

2.1.4 Locating Jumpers on the Board

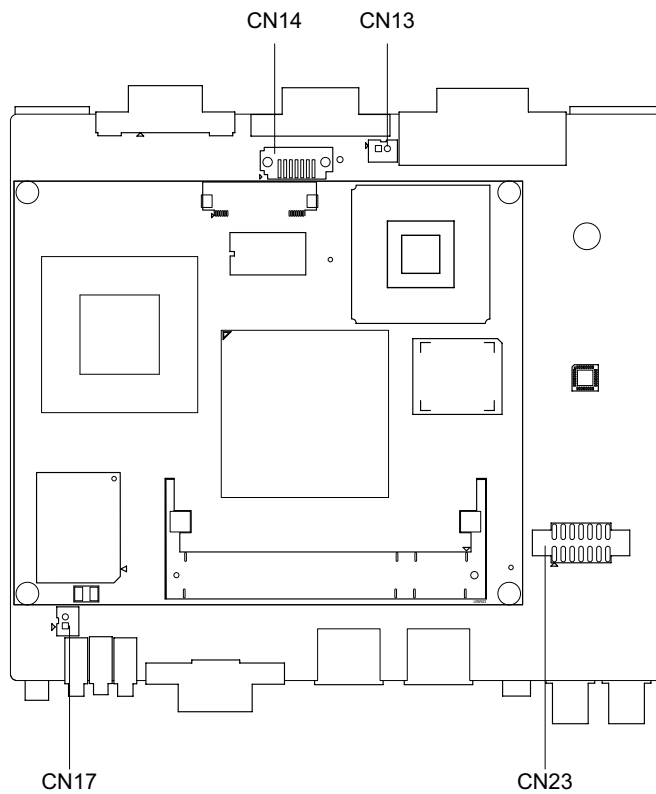

Figure 2.1 Locating Jumpers on the Board-Top side

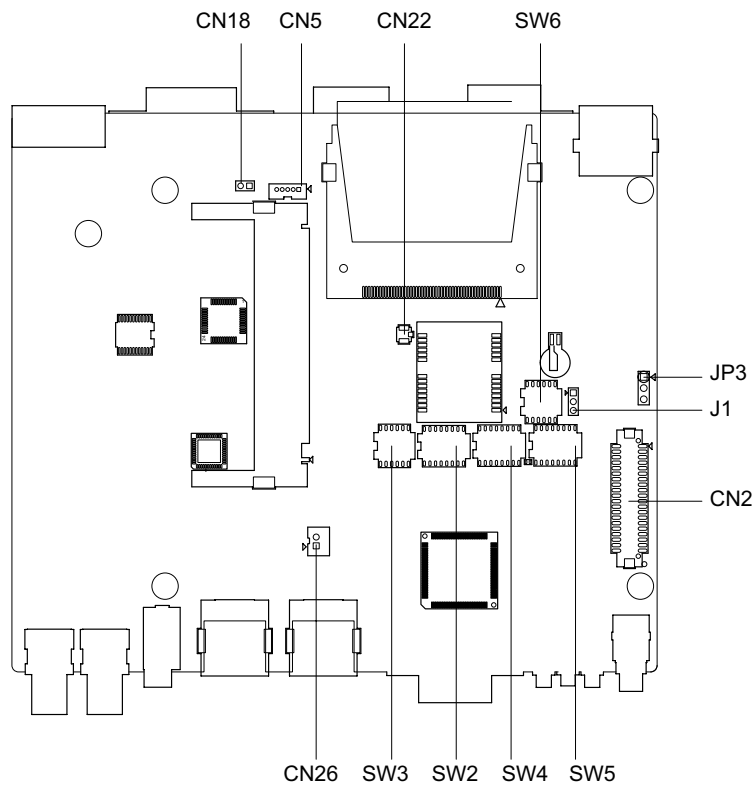

Figure 2.2 Locating Jumpers on the Board-Bottom side

2.2 Connectors

2.2.1 Connector position

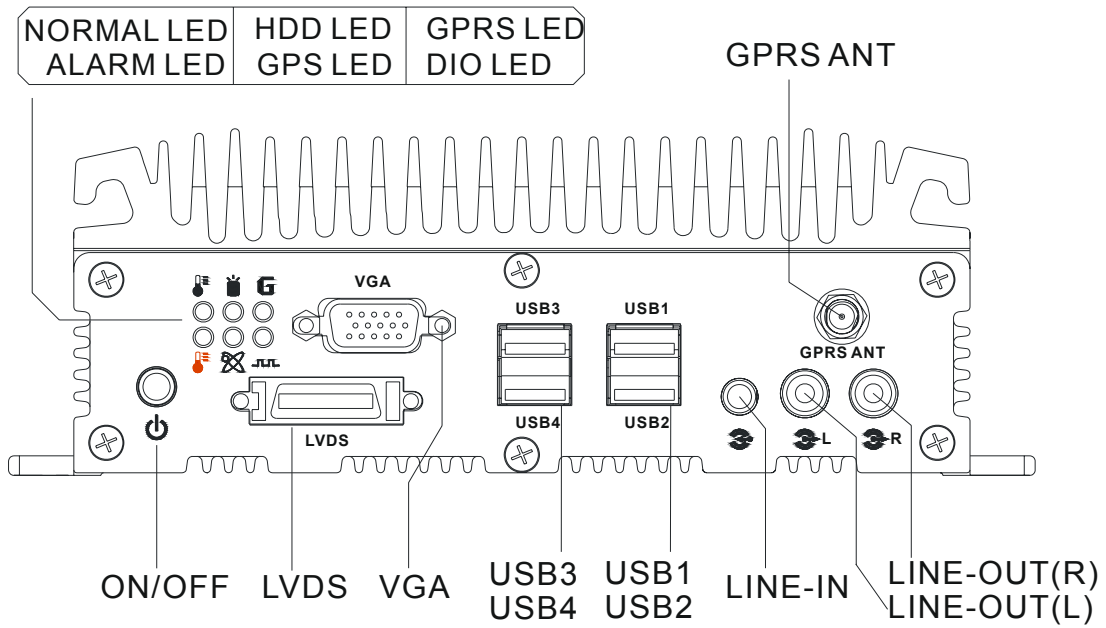

Figure 2.3 ARK-1388V Front I/O Panel

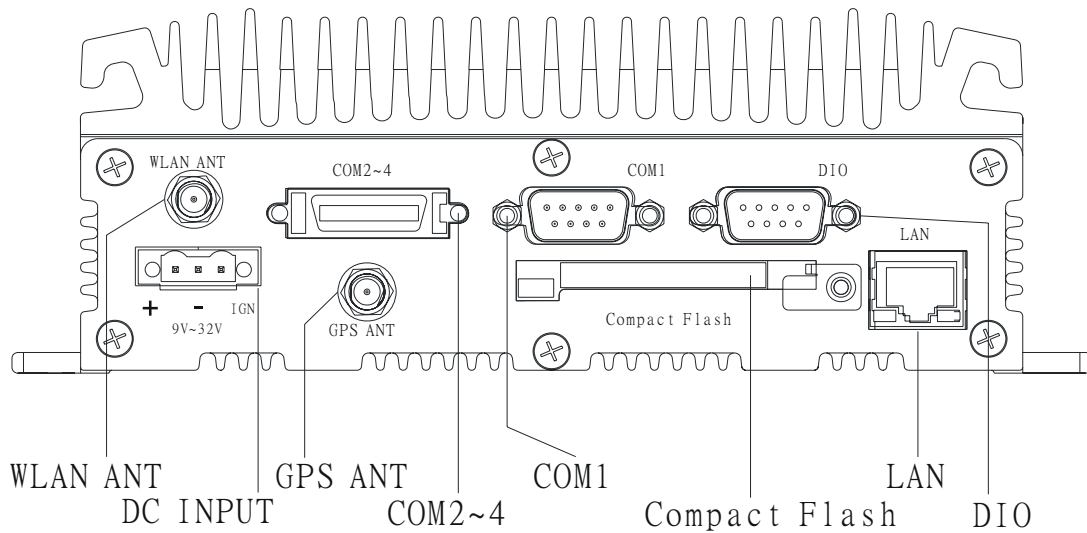

Figure 2.4 ARK-1388V Rear I/O Panel

2.2.2 ARK-1388V front side external I/O connectors

2.2.2.1 USB Connector

ARK-1388V provides four connectors of USB interface, which give complete Plug & Play and hot swapping for up to 127 external devices. The USB interface complies with USB UHCI, Rev. 2.0 compliant. The USB interface can be disabled in the system BIOS setup. Please refer to Table. 2.1 for its pin assignments.

The USB connectors are used for connecting any device that conforms to the USB interface. Many recent digital devices conform to this standard. The USB interface supports Plug and Play, which enables you to connect or disconnect a device whenever you want, without turning off the computer.

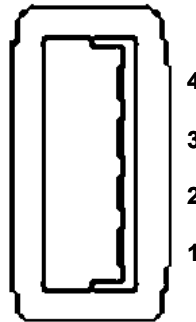

Figure 2.5 USB connector

Table 2.11: USB Connector

Pin	Signal name	Pin	Signal name
1	VCC	2	USB_data-
3	USB_data+	4	GND

2.2.2.2 VGA Connector

The ARK-1388V provides a high resolution VGA interface by a D-sub 15-pin connector to support a VGA CRT monitor. It supports display resolution up to 1600 x 1200 @75-Hz and up to 64 MB shared memory.

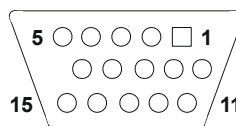

Figure 2.6 VGA connector

Table 2.12: VGA connector pin assignments

Pin	Signal name
1	Red
2	Green
3	Blue
4	NC
5	GND
6	GND
7	GND

Table 2.12: VGA connector pin assignments

8	GND
9	NC
10	GND
11	NC
12	NC
13	H-SYNC
14	V-SYNC
15	NC

2.2.2.3 LVDS Connector

The ARK-1388V comes with a D-Sub 26-pin connector that carries LVDS signal output, and can direct connect to LVDS LCD Display via external cable.

The system also provide a jumper of J1 on internal motherboard for selecting the LCD signal power of 5V or 3.3V, please refer to section 2.1.3 for the jumper table of J1, and Chapter 6 of "Full Disassembly Procedure to set it. Up. The default setting of J1 is 5V.

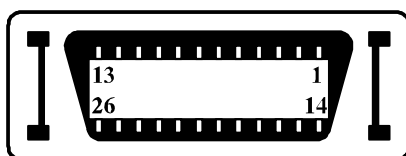
**Figure 2.7 LVDS Connector****Table 2.13: LVDS Connector Pin Assignments**

Pin	Signal Name	Pin	Signal name
1	CLK2P	14	CLK2M
2	GND	15	A0M
3	A0P	16	A1M
4	A1P	17	A2M
5	A2P	18	CLK1M
6	CLK1P	19	GND
7	VCC_LCD	20	VDD_LCD
8	GND	21	A3M
9	A3P	22	A4M
10	A4P	23	A5M
11	A5P	24	A6M
12	A6P	25	A7M
13	A7P	26	GND

2.2.2.4 Audio

ARK-1388V provides two BNC connectors, which offer AC'97 stereo amplifier 6W line-out for left and right channel. ARK-1388V also provides a phone jack as Mic -in function,

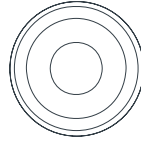

Figure 2.8 BNC Connector

Table 2.14: Left Line Out pin assignments

Pin	Signal Name
1	LIN-OUT-L-
2	LIN-OUT-L+
3	LIN-OUT-L+

Table 2.15: Right Line Out pin assignments

Pin	Signal Name
1	LIN-OUT-R-
2	LIN-OUT-R+
3	LIN-OUT-R+

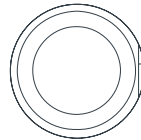

Figure 2.9 phone Jack Connector

Table 2.16: Mic in pin assignments

Pin	Signal Name
1	GND
2	MIC1L
3	NC
4	MIC1R
5	GND

2.2.2.5 LED Indicators

There are six LEDs on ARK-1388V front metal face plate for indicating system status: Normal LED detects internal temperature. When under 90° C, Normal LED flashes blue. When the internal temperature is over 90° C, Normal LED will not flash, but Alarm LED will flash orange; air flow should be enhanced to dissipate heat. HDD LED is for compact flash disk status, which flashes red when active. The GPS/GPRS/DIO LED flashes green when these functions are active. (ARK-1388VV by default has no GPRS function, therefore the GPRS LED won't flash until user plugs in AMO-EDGE or AMO-HSDPA; DIO function is reserved LED for user to program as its unique application,)

2.2.2.6 GPRS Antenna

There is one SMA female connector on ARK-1388V front metal face plate for external GPRS or HSDPA antenna. ARK-1388V by default is not equipped with GPRS/HSDPA module; the SMA connector is reserved to connect with external antenna which may be purchased: AMO-EDGE or AMO-HSDPA.

2.2.2.7 Power on/off bottom

ARK-1388V comes with a Power On/Off button which flashes yellow to indicate power on.

2.2.3 ARK-1388V rear side external I/O connectors

2.2.3.1 Ethernet Connector (LAN)

ARK-1388V is equipped with an Intel 82562GZ Ethernet controller that is fully compliant with IEEE 802.3u 10/100Base-T CSMA/CD standards. The Ethernet port provides a standard RJ-45 jack connector with LED indicators on the front side to show its Active/Link status (Green LED) and Speed status (Yellow LED).

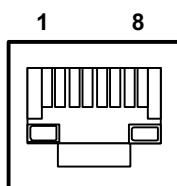

Figure 2.10 Ethernet connector

Table 2.17: RJ-45 Connector pin assignments

Pin	10/100/1000BaseT Signal Name
1	TX+
2	TX-
3	RX+
4	RJ45_CM1_R
5	RJ45_CM1_R
6	RX-
7	RJ45_CM2_R
8	RJ45_CM2_R

2.2.3.2 DIO Connector

ARK-1388V provides one D-sub 9-pin connectors, which offers 6-bit Digital IO interface ports. The 4 digital input and 2 digital output with relay can read or control devices.

The 4-bit digital input with isolation and 2-bit digital output with relay.

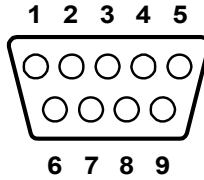

Figure 2.11 DIO connector

Table 2.18: DIO cable pin color to DIO pin assignments

Pin	PIN color	Signal Name
1	Black	DO0_CON
2	Brown	DO1_CON+
3	Red	DI0_CON+
4	Orange	DI2_CON+
5	Yellow	ISO_GND
6	Green	DO0_CON-
7	Blue	DO1_CON-
8	Purple	DI1_CON+
9	Grey	DI3_CON+

To connect with your devices, please use cable from package, P/N: 1700012536 which is D-sub to 10pin phoenix connector.

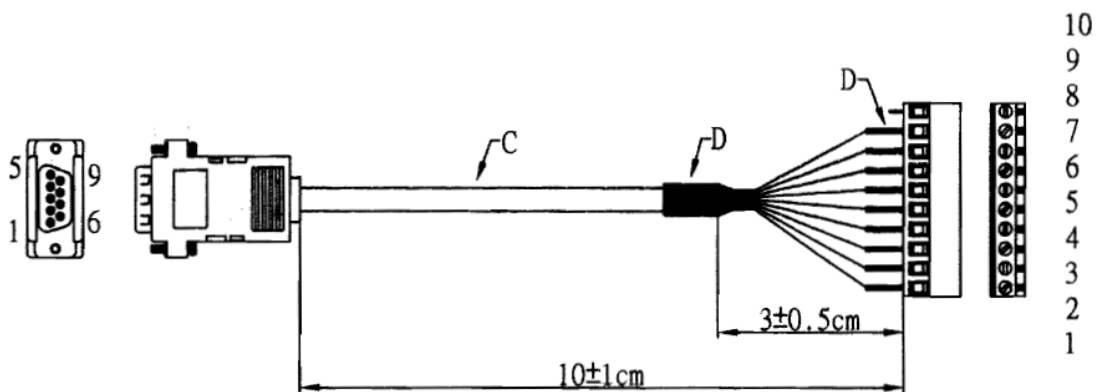

Figure 2.12 DIO cable

Table 2.19: DIO port pin assignments

Pin	Signal Name
1	Black DO0_CON+
2	Brown DO0_CON-
3	Red DO1_CON+
4	Orange DO1_CON-

Table 2.19: DIO port pin assignments

5	Yellow	DI0_CON+
6	Green	DI1_CON+
7	Blue	DI2_CON+
8	Purple	DI3_CON+
9	Grey	ISO_GND

2.2.3.3 COM1 Connector

ARK-1388V provides one D-sub 9-pin connector, which offers RS-232/422/485 serial communication interface ports. Default setting is RS-485, if you want to use RS-422/485, you can find the jumper installation SW2/3 jumper setting in 2.13.

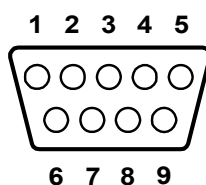
**Figure 2.13 COM connector****Table 2.20: COM standard serial port pin assignments**

Pin	Signal Name
1	DCD3#
2	RX3#
3	TX3#
4	DTR3#
5	GND
6	DSR3#
7	RTS3#
8	CTS3#
9	RI3#

2.2.3.4 COM2~4

ARK-1388V provides one D-sub 26-pin connector, which offers 1 x RS-232 and 2 x RS-232/422/485 serial communication interface ports. Default setting is RS-232, if you want to use RS-422/485, you can find the jumper installation SW3/4/5/6 jumper setting in 2.13.

Table 2.21: D-SUB CONN 26P pin assignments

Pin	signal name
1	DCD0#
2	RX0#
3	TX0#
4	DTR0#
5	DCD2#
6	RX2#
7	GND
8	CTS2#
9	RI2#
10	DSR1#
11	RTS1#
12	CTS1#
13	RI1#
14	TX1#
15	RTS0#
16	CTS0#
17	RI0#
18	DSR2#
19	RTS2#
20	TX2#
21	DTR2#
22	DCD1#
23	RX1#
24	TX1#
25	DTR1#
26	GND

To connect with your devices, please use cable from package, P/N: 1700012535 which is D-sub 26pin to 3 x serial ports cable. COM2~3 support RS-232/422/485 but COM4 supports RS-232 only.

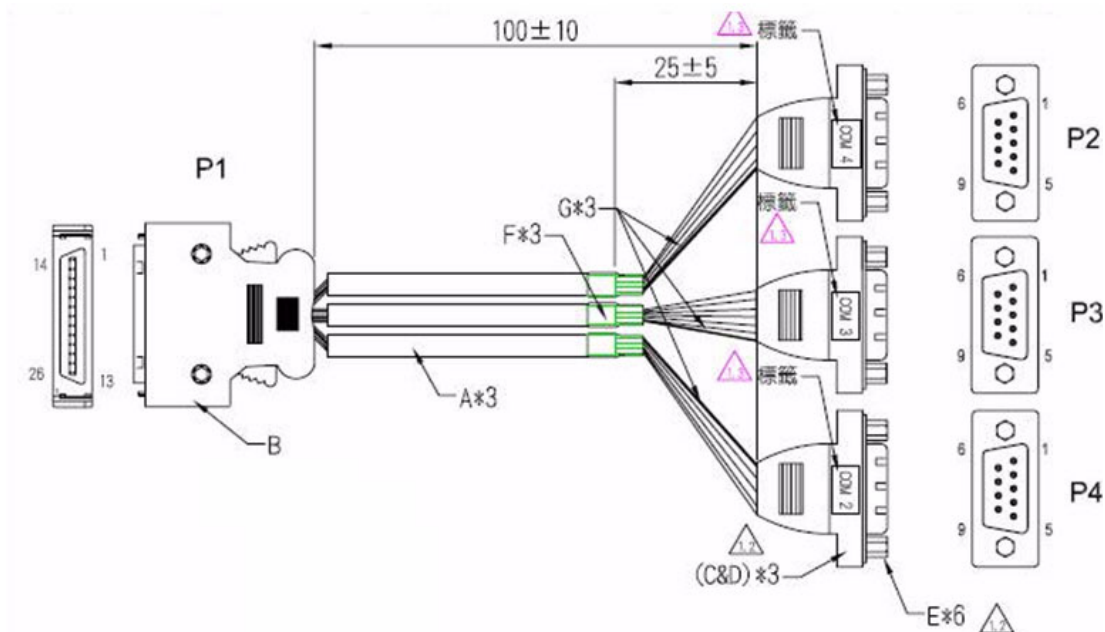

Figure 2.14 COM2~4 cable

2.2.3.5 Compact Flash Card

ARK-1388V is equipped with an external CF card. You can find the installation in Appendix.

2.2.3.6 Power Input Connector

ARK-1388V comes with a three-pin header that carries 9~32 VDC external power input.

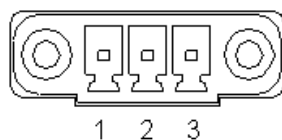

Figure 2.15 Power Input Connector

Table 2.22: Power connector pin assignments

Pin	Signal Name
1	Power in
2	GND
3	IGN

2.2.3.7 GPS Antenna

There is one SMA Female connector on ARK-1388V front metal face plate for external GPS antenna. ARK-1388V default built in GPS chip and with one GPS antenna in package, antenna P/N is 1750001782.

2.2.3.8 WLAN Antenna

There is one SMA Male connector on ARK-1388V front metal face plate for external WLAN antenna. ARK-1388V default does not equip with WLAN module, the SMA connector is reserved to connect with external antenna which you may purchase WLAN miniPCI card and antenna together.

Chapter 3

BIOS Settings

3.1 BIOS Introduction

AwardBIOS 6.0 is a full-featured BIOS provided by Advantech to deliver superior performance, compatibility, and functionality to industrial PCs and embedded boards. Its many options and extensions let you customize your products to a wide range of designs and target markets.

The modular, adaptable AwardBIOS 6.0 supports the broadest range of third-party peripherals and all popular chipsets, plus Intel, AMD, nVidia, VIA, and compatible CPUs from 386 through Pentium, AMD Geode, K7 and K8 (including multiple processor platforms), and VIA Eden C3 and C7 CPUs.

You can use Advantech's utilities to select and install features that suit your needs and your customers' needs.

3.2 BIOS Setup

The ARK-1388V system has AwardBIOS 6.0 built-in, which includes a CMOS SETUP utility that allows users to configure settings as required or to activate certain system features.

The CMOS SETUP saves configuration settings in the CMOS RAM of the motherboard. When the system power is turned off, the onboard battery supplies the necessary power to the CMOS RAM so that settings are retained.

To access the CMOS SETUP screen, press the button during the power-on BIOS POST (Power-On Self Test).

CMOS SETUP Navigation and Control Keys:

< ↑ >> ↓ >> ← >> → >	Move to highlight item
<Enter>	Select Item
<Esc>	Main Menu - Start Quit sequence Sub Menu - Exit the current page and return to level above
<Page Up/+>	Increase the numeric value or make changes
<Page Down/->	Decrease the numeric value or make changes
<F1>	General help, for Setup Sub Menu
<F2>	Item Help
<F5>	Load Previous Values
<F7>	Load Optimized Default
<F10>	Save all CMOS changes

3.2.1 Main Menu

Press the key during startup to enter the BIOS CMOS Setup Utility; the Main Menu will appear on the screen. Use arrow keys to highlight the desired item, and press <Enter> to accept, or enter the sub-menu.



- **Standard CMOS Features**
This setup page includes all the features for standard CMOS configuration.
- **Advanced BIOS Features**
This setup page includes all the features for advanced BIOS configuration.
- **Advanced Chipset Features**
This setup page includes all the features for advanced chipset configuration.
- **Integrated Peripherals**
This setup page includes all onboard peripheral devices.
- **Power Management Setup**
This setup page includes all the power management items.
- **PnP/PCI Configurations**
This setup page includes PnP OS and PCI device configuration.
- **PC Health Status**
This setup page includes the system auto-detect CPU and system temperature, voltage, and fan speed.
- **Frequency/Voltage Control**
This setup page includes CPU host clock control, frequency ratio and voltage.
- **Load Optimized Defaults**
This selection loads optimized values for best system performance configuration.

- **Set Password**
Establish, change or disable passwords.
- **Save & Exit Setup**
Save CMOS value settings to CMOS and exit BIOS setup.
- **Exit Without Saving**
Abandon all CMOS value changes and exit BIOS setup.

3.2.2 Standard CMOS Features

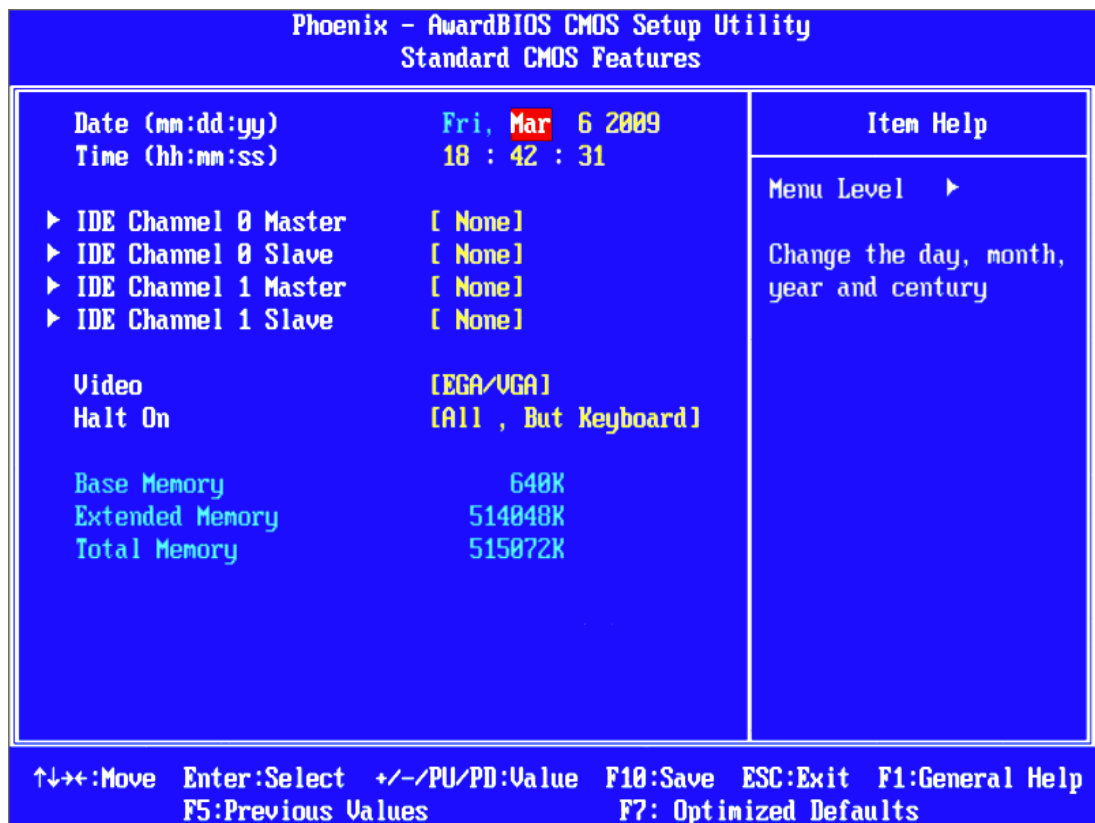

- **Date**
The date format is <weekday>, <month>, <day>, <year>.
 Weekday From Sun to Sat, determined and display by BIOS only
 Month From Jan to Dec.
 Day From 1 to 31
 Year From 1999 through 2098
- **Time**
The time format is <hour> <minute> <second>, based on 24-hour time.
- **IDE Channel 0 Master/Slave**
IDE HDD Auto-Detection - Press "Enter" for automatic device detection.

- **Halt on**

This item determines whether the computer will stop if an error is detected during power up.

No Errors	The system boot process will not stop for any error
All Errors	Whenever the BIOS detects a non-fatal error the system boot process will be stopped.
All, But Keyboard	The system boot process will not stop for a keyboard error, but will stop for all other errors. (Default value)
All, But Diskette	The system boot process will not stop for a diskette error, but will stop for all other errors.
All, But Disk/Key	The system boot process will not stop for a keyboard or disk error, but will stop for all other errors.

- **Base Memory**

Displays the amount of base (or conventional) memory installed in the system.

- **Extended Memory**

Displays the amount of extended memory (above 1 MB in CPU's memory address map) installed in the system.

- **Total Memory**

Displays the total system memory size.

3.2.3 Advanced BIOS Features

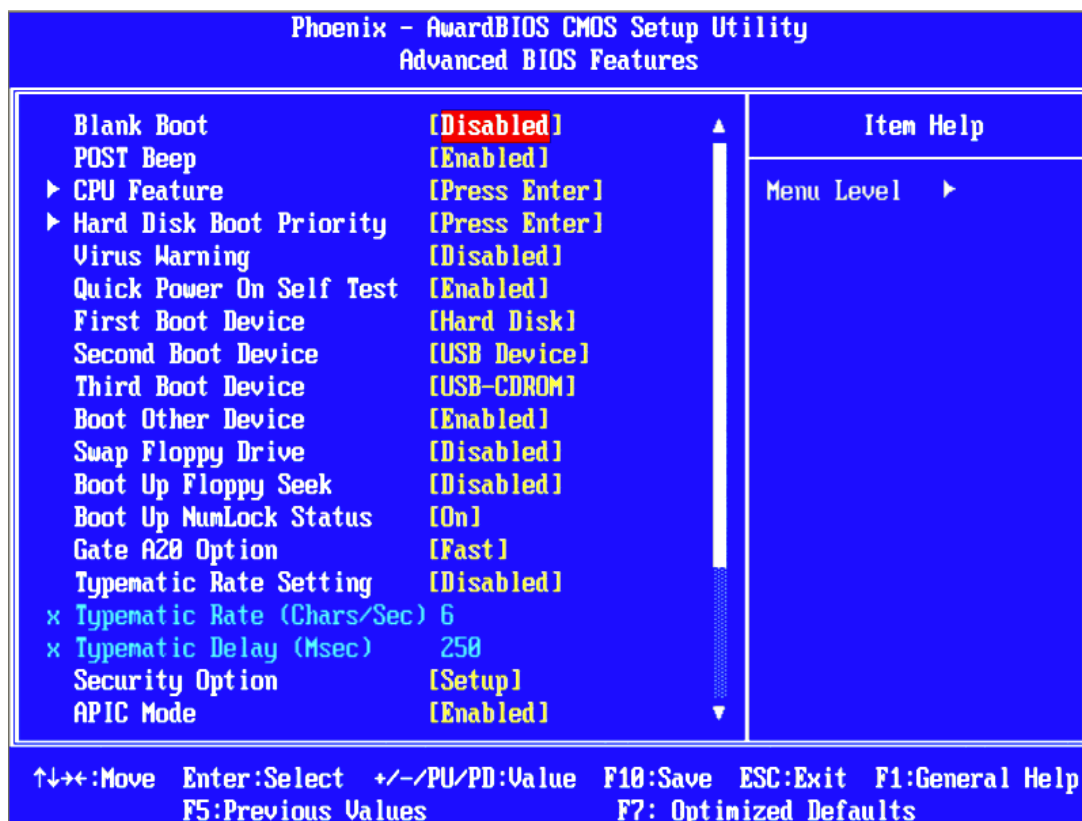

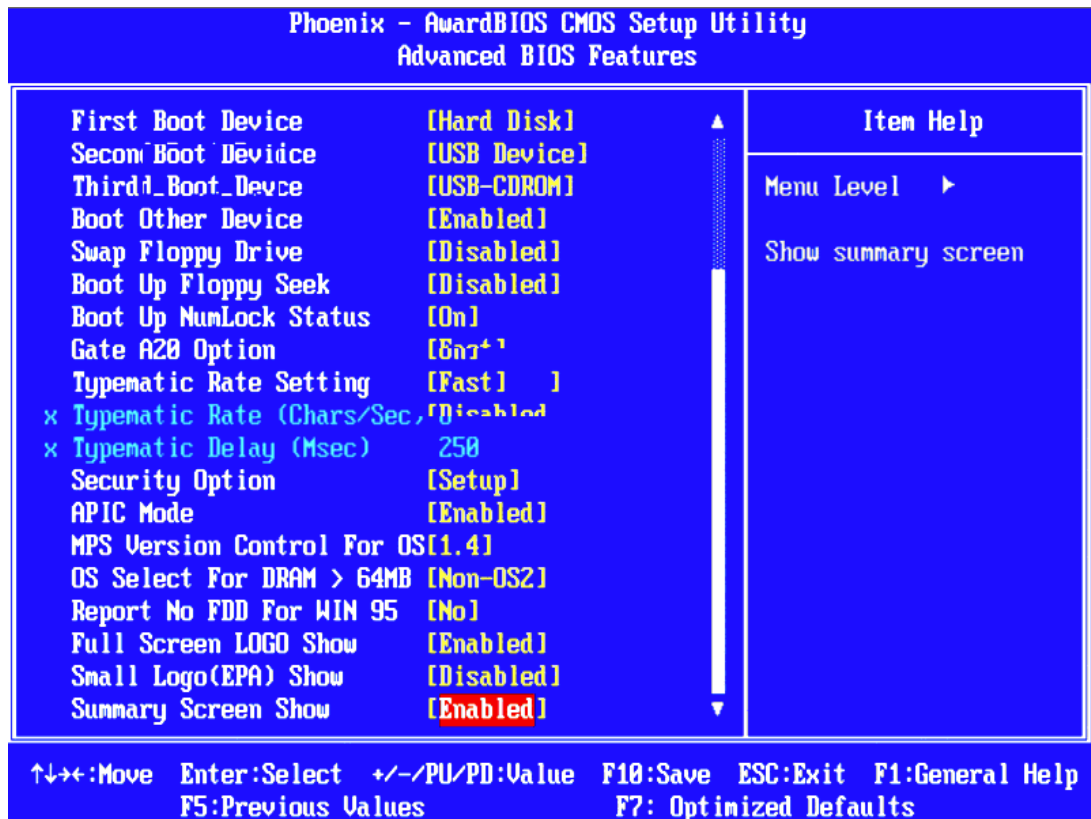

- **CPU Feature**
This item allows the user to adjust CPU settings such as CPU ratio, VID and Thermal, and special features like XD flag.
- **Hard Disk Boot Priority**
This item allows the user to select the boot sequence for system devices such as HDD, SCSI, and RAID.
- **CPU L1 & L2 Cache [Enabled]**
This item allows user to enable CPU L2 cache and ECC checking function.
- **CPU L3 Cache [Enabled]**
This item allows the user to enable/disable CPU L3 cache.
- **Hyper-Threading Technology [Enabled]**
This item allows the user to enable/disable Hyper-threading support for the Intel® Pentium® 4 processor with HT Technology.
- **Quick Power On Self Test [Enabled]**
This field speeds up the Power-On Self Test (POST) routine by skipping re-testing a second, third and fourth time. The default setting is enabled.
- **First / Second / Third / Other Boot Drive**

Hard Disk	Sets boot priority for the hard disk.
CDROM	Sets boot priority for CDROM.
USB-FDD	Sets boot priority for USB-FDD.
USB-ZIP	Sets boot priority for USB-ZIP.
USB-CDROM	Sets boot priority for USB-CDROM.
LAN	Sets boot priority for LAN.
Disabled	Disables this boot function.

- **Boot Up NumLock Status [On]**
This item allows the user to activate the Number Lock key at system boot.
- **Gate A20 Option [Fast]**
This item allows the user to switch on or off A20 control by port 92.
- **Typematic Rate Setting**
This item allows the user to set the two typematic control items.
This field controls the speed of
 - Typematic Rate (Chars/Sec)
This item controls the speed at which the system registers auto repeated key-strokes.
The eight settings are: 6, 8, 10, 12, 15, 20, 24 and 30.
 - Typematic Delay (Msec)
This item sets the key press delay time before auto repeat begins. The four delay rate options are: 250, 500, 750 and 1000.
- **Security Option [Setup]**

System	System requires correct password before booting, and also before permitting access to the Setup page.
Setup	System will boot, but requires correct password before permitting access to Setup. (Default value)
- **APIC Mode[Enabled]**
This item allows the user to enable/disable the "Advanced Programmable Interrupt Controller". APIC is implemented in the motherboard and must be supported by the operating system; it extends the number of IRQs available.
- **MPS Version Control for OS[1.4]**
This item sets the operating system multiprocessor support version.
- **OS Select For DRAM > 64 MB[Non-OS2]**
Select OS2 only if the system is running the OS/2 operating system with greater than 64 MB of RAM on the system.

3.2.4 Advanced Chipset Features

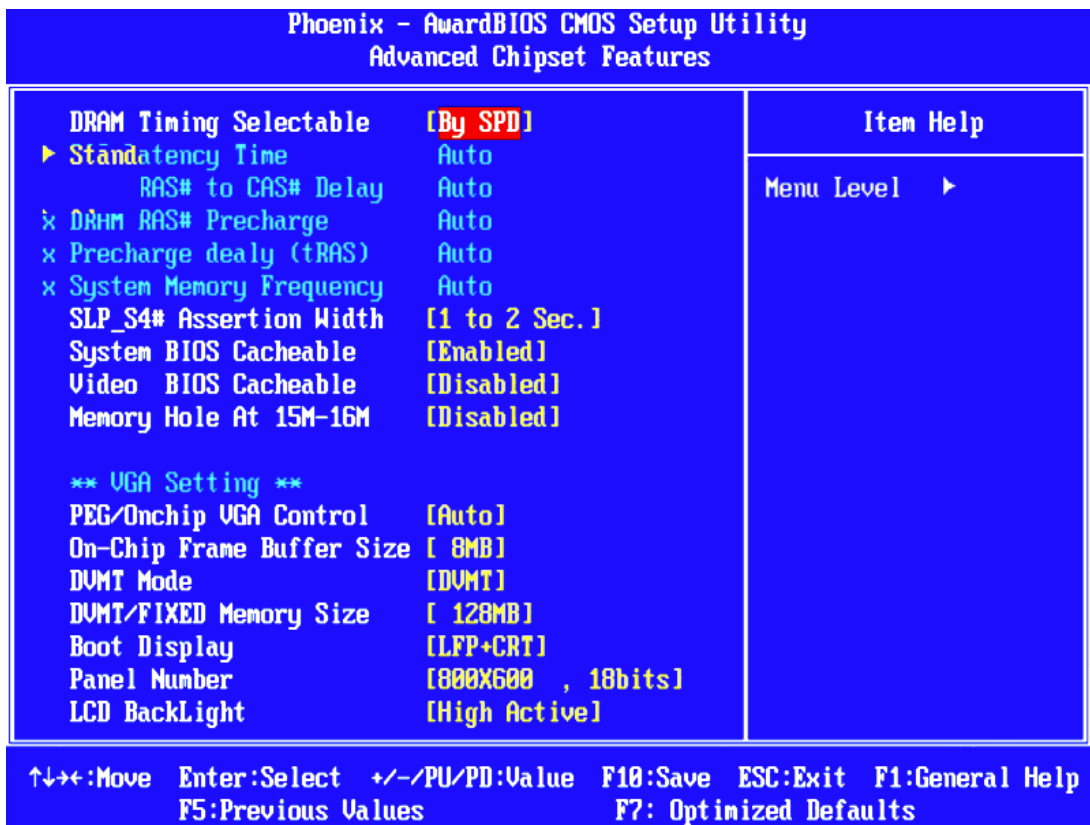

Note!  The "Advanced Chipset Features" screen controls the configuration of the board's chipset register settings and performance tuning - the options on this screen may vary depending on the chipset type. It is strongly recommended that only technical users make changes to the default settings.

- **DRAM Timing Selectable [By SPD]**
This item allows the user to set the optimal timings for items 2 through 5, system default setting of "By SPD" to follow the SPD information and ensure the system running in stable and optimal performance.
- **CAS Latency Time [Auto]**
This item allows the user to set the timing delay in clock cycles before SDRAM start a read command after receiving it.
- **DRAM RAS# to CAS# Delay [Auto]**
This item allows the user to set the timing of the transition from RAS (row address strobe) to CAS (column address strobe) as both rows and column are separately addressed shortly after DRAM is refreshed.
- **DRAM RAS# Precharge [Auto]**
This item allows the user to set the DRAM RAS# precharge timing, system default is setting to "Auto" to reference the data from SPD ROM.
- **Precharge delay (tRAS) [Auto]**
This item allows the user to adjust memory precharge time
- **System Memory Frequency [Auto]**
This item allows the user to adjust memory frequency to improvement performance.

- **System BIOS Cacheable [Enabled]**
This item allows the system BIOS to be cached to allow faster execution and better performance.
- **Video BIOS Cacheable [Disabled]**
This item allows the video BIOS to be cached to allow faster execution and better performance.
- **Memory Hole At 15M-16M [Disabled]**
This item reserves 15 -16MB memory address space to ISA expansion cards that specifically require the setting. Memory from 15 -16MB will be unavailable to the system because of the expansion cards can only access memory at this area.
- **PCI Express Root Port Func [Press Enter]**
This item allows the user to adjust the PCIE port to on, off, or auto.
- **PEG/Onboard VGA Control [Auto]**
This item allows the user to select the onboard graphics processor or the PCI Express card.
- **PEG Force X1 [Disabled]**
This item allows the user to convert a PCI Express X16 slot to PCI Express X1 slot.
- **On-Chip Frame Buffer Size [8MB]**
This item allows the user to adjust the memory buffer for on-chip graphics.
- **DVMT Mode [DVMT]**
This item allows the user to adjust Intel's Dynamic Video Memory Technology (DVMT). Bios provide three option to choose (DVMT, FIXED and Both).
- **DVMT/FIXED Memory Size [128MB]**
This item allows the user to adjust DVMT/FIXED graphics memory size.
- **Boot Display [CRT]**
This item allows the user to decide which display mode to use for the boot display.
- **Panel Type [640 x 480]**
This item allows the user to adjust panel resolution.

3.2.5 Integrated Peripherals

Phoenix - AwardBIOS CMOS Setup Utility		Item Help
Integrated Peripherals		Menu Level ▶
▶ OnChip IDE Device	[Press Enter]	
▶ Onboard Device	[Press Enter]	
▶ SuperIO Device	[Press Enter]	

↑↓→←:Move Enter:Select +/-/PU/PD:Value F10:Save ESC:Exit F1:General Help
 F5:Previous Values F7: Optimized Defaults

Phoenix - AwardBIOS CMOS Setup Utility		Item Help
OnChip IDE Device		Menu Level ▶▶
IDE HDD Block Mode	[Enabled]	If your IDE hard drive supports block mode select Enabled for automatic detection of the optimal number of block read/writes per sector the drive can support
IDE DMA transfer access	[Enabled]	
On-Chip Primary PCI IDE	[Enabled]	
IDE Primary Master PIO	[Auto]	
IDE Primary Slave PIO	[Auto]	
IDE Primary Master UDMA	[Auto]	
IDE Primary Slave UDMA	[Auto]	
On-Chip Secondary PCI IDE	[Enabled]	
IDE Secondary Master PIO	[Auto]	
IDE Secondary Slave PIO	[Auto]	
IDE Secondary Master UDMA	[Auto]	
IDE Secondary Slave UDMA	[Auto]	
*** On-Chip Serial ATA Setting ***		
x SATA Mode	IDE	
On-Chip Serial ATA	[Disabled]	
x SATA PORT Speed Settings	Disabled	
x PATA IDE Mode	Secondary	
SATA Port	P0,P2 is Primary	

↑↓→←:Move Enter:Select +/-/PU/PD:Value F10:Save ESC:Exit F1:General Help
 F5:Previous Values F7: Optimized Defaults

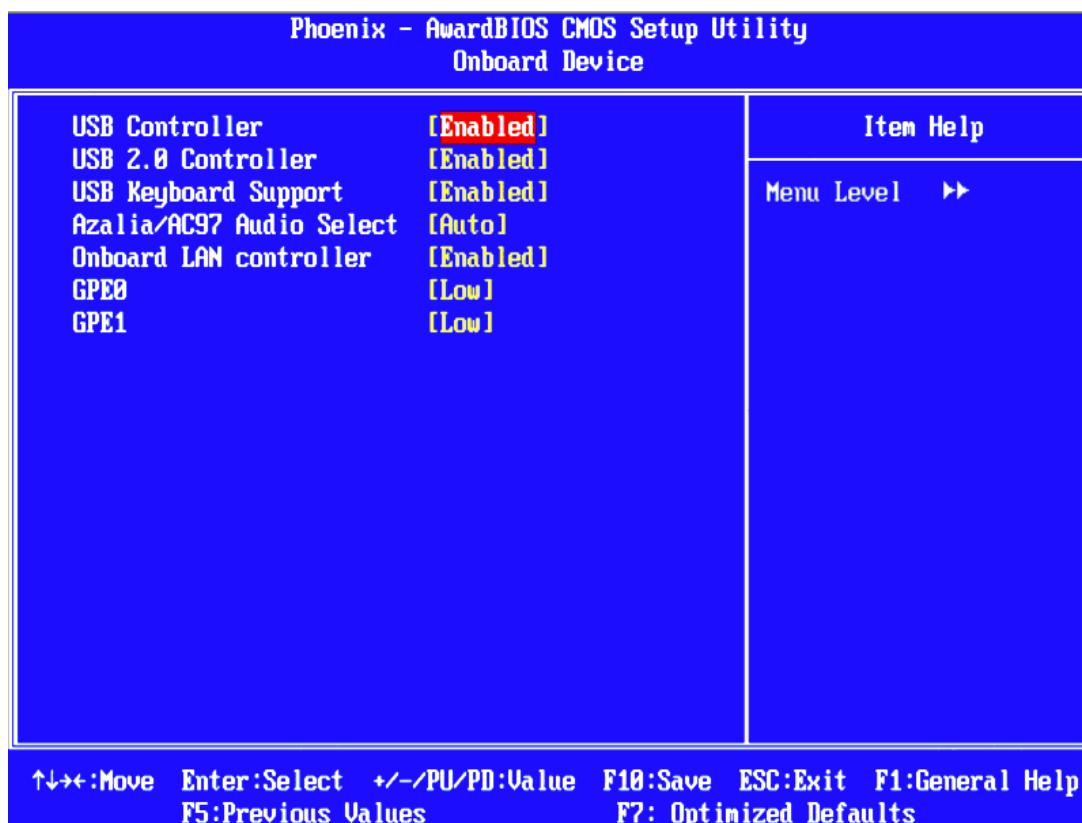

Note!  The "Integrated Peripherals" screen controls chipset configuration for IDE, ATA, SATA, USB, AC97, MC97 and Super IO and Sensor devices. The options on this screen vary depending on the chipset.

- **OnChip IDE Device**
This item allows the user to set the OnChip IDE device status, including IDE devices and setting PIO and DMA access modes. Some chipsets support newer SATA devices (Serial-ATA).
- **Onboard Device**
This item allows the user to set the Onboard device status, includes enable USB, AC97, MC97 and LAN devices.
- **Super IO Device**
This item allows the user to set the Super IO device status, includes enable Floppy, COM, LPT, IR and control GPIO and Power fail status.

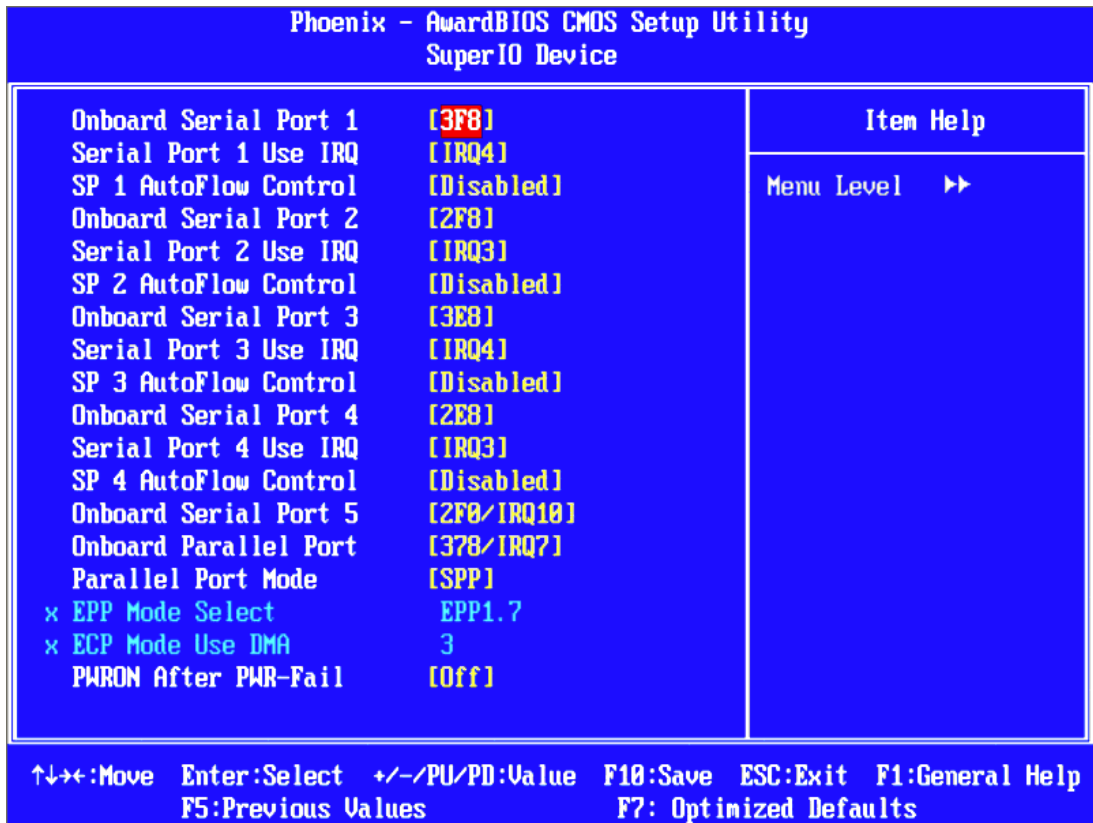



- **Onboard Serial port 1 [3F8]**
This item allows the user to adjust serial port 1 address.
- **Serial port 1 Use IRQ [IRQ3]**
This item allows the user to adjust serial port 1 IRQ.
- **Onboard Serial port 2 [2F8]**
This item allows the user to adjust serial port 2 address.
- **Serial port 2 Use IRQ [IRQ4]**
This item allows the user to adjust serial port 2 IRQ.
- **Onboard Parallel Port [378/IRQ7]**
This item allows the user to adjust parallel port address and IRQ.
- **Parallel Port Mode [Standard]**
This item allows the user to adjust parallel port mode.
- **ECP Mode Use DMA [3]**
This item allows the user to adjust the ECP DMA resource.
- **Serial port 3 [3E8]**
This item allows the user to adjust serial port 3 address.
- **Serial 3 IRQ [IRQ5]**
This item allows the user to adjust serial port 3 IRQ.
- **Serial port 4 [2E8]**
This item allows the user to adjust serial port 4 address.
- **Serial 4 IRQ [IRQ7]**
This item allows the user to adjust serial port 4 IRQ.
- **Serial port 5 [4E8]**
This item allows the user to adjust serial port 5 address.

- **Serial 5 IRQ** [IRQ10]
This item allows the user to adjust serial port 5 IRQ.
- **Serial port 6** [4F8]
This item allows the user to adjust serial port 6 address.
- **Serial 6 IRQ** [IRQ11]
This item allows the user to adjust serial port 6 IRQ.
- **COM3 Mode** [RS232]
This item allows the user to adjust the UART mode. The BIOS provides three items to choose from: RS-232, RS-422, and R-S485.
- **COM4 Mode** [RS232]
This item allows the user to adjust the UART mode. The BIOS provides three items to choose from: RS-232, RS-422, and RS-485.

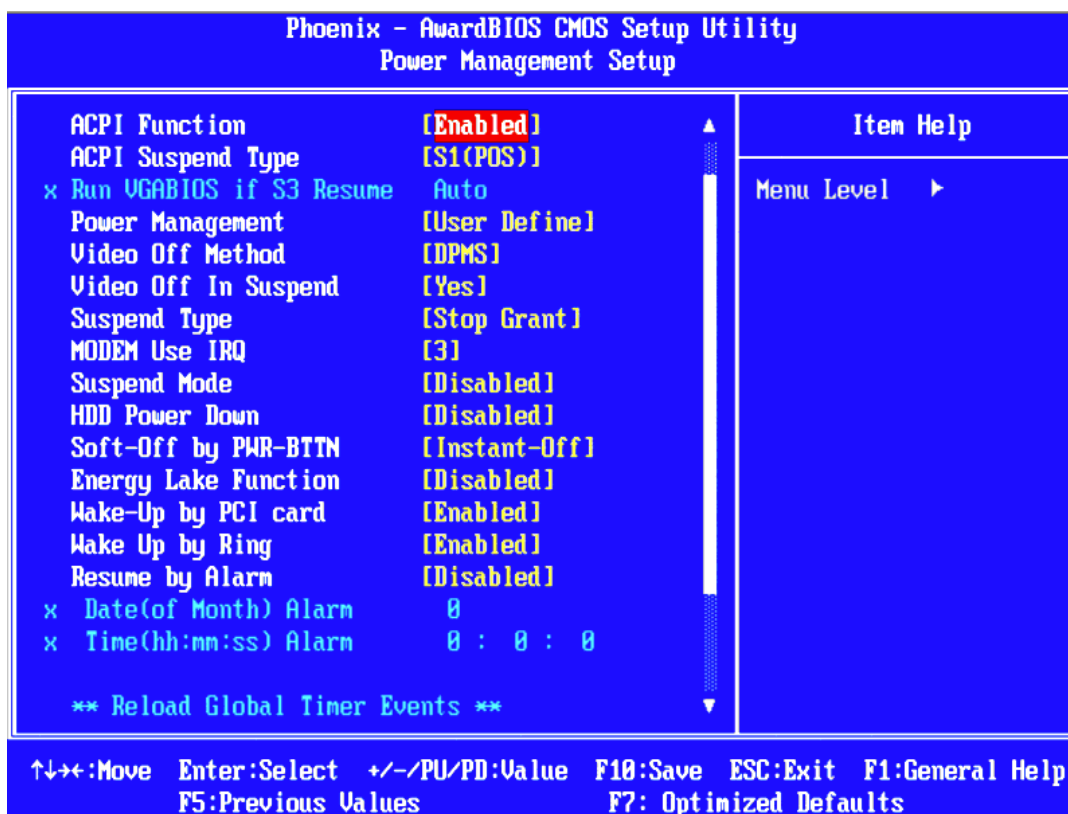
3.2.6 Power Management Setup

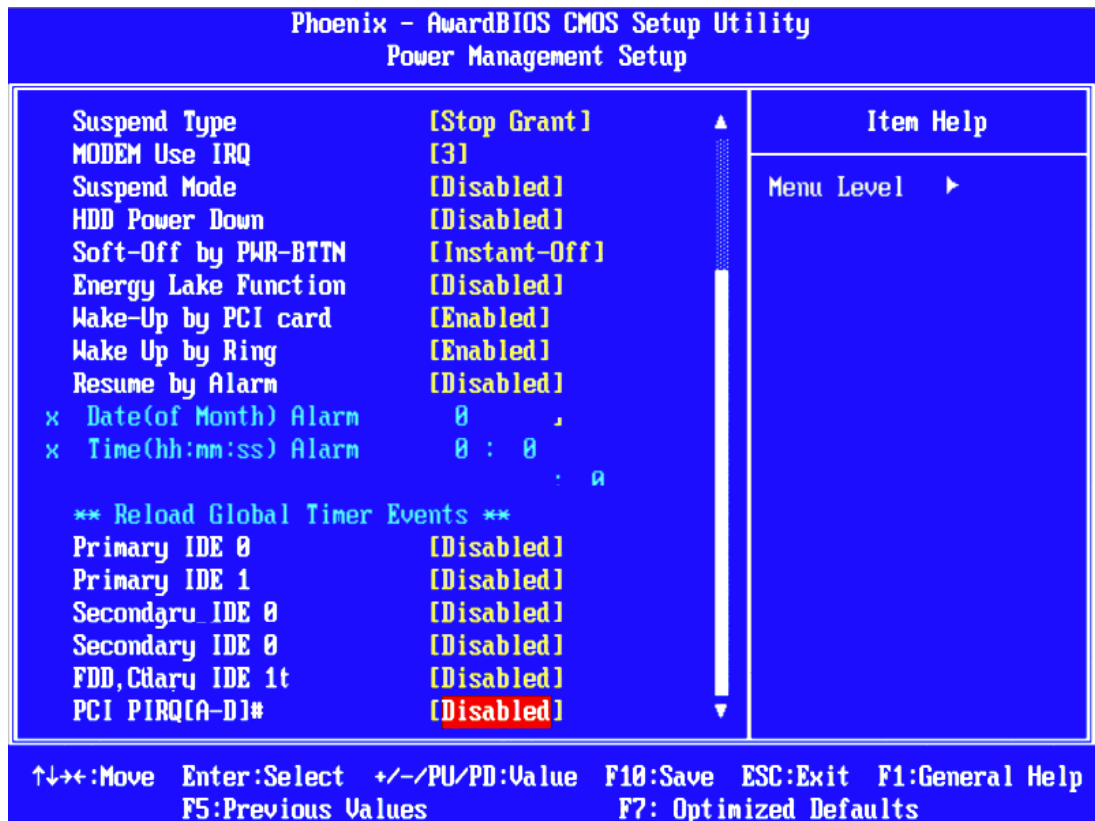



Note!  The "Power Management Setup" screen allows configuration of the system for effective energy savings while still operating in a manner consistent with intended computer use.

■ **ACPI Function [Enabled]**

This item defines the ACPI (Advanced Configuration and Power Management) feature that makes hardware status information available to the operating system, and communicate PC and system devices for improving the power management.

■ **ACPI Suspend Type [S3 (STR)]**

This item allows user to select sleep state when the computer is in suspend mode.

- | | |
|----------|-------------------------------------------------------------------------------------|
| S1 (POS) | The suspend mode is equivalent to a software power down. |
| S3 (STR) | The system shuts down with the exception of a refresh current to the system memory. |

■ **Power Management [Min Saving]**

This item allows user to select system power saving mode.

- | | |
|-------------|--------------------------------------------------------------------------------------|
| Min Saving | Minimum power management. Suspend Mode=1 hr. |
| Max Saving | Maximum power management. Suspend Mode=1 min. |
| User Define | Allows user to set each mode individually.
Suspend Mode= Disabled or 1 min ~1 hr. |

- **Video Off Method° [DPMS]**
 This item allows the user to determine the manner in which the monitor is blanked.

V/H SYNC+Blank	This option will cause the system to turn off vertical and horizontal synchronization ports and write blanks to the video buffer.
Blank Screen	This option only writes blanks to the video buffer.
DPMS	Initial display power management signaling.
- **Video Off In Suspend [Yes]**
 This item allows user to turn off video during system enter suspend mode.
- **Suspend Type [Stop Grant]**
 This item allows user to determine the suspend type.
- **Modem use IRQ [3]**
 This item allows user to determine the IRQ which the MODEM can use.
- **Suspend Mode [1 Hour]**
 This item allows user to determine the time of system inactivity, all devices except the CPU will be shut off.
- **HDD Power Down Mode [15 Min]**
 This item allows user to determine the time of system inactivity, the hard disk drive will be powered down.
- **Soft-Off by PWR-BTTN° [Instant-Off]**
 This item allows the user to define the power button functions.

Instant-Off	Press the power button to power off instantly.
Delay 4 Sec	Press and hold the power button for 4 sec to power off.
- **PWRON After PWR-Fail [Former-Sts]**
 This item allows the user to select recovery after power fail function; this function depends on the chipset.
- **Wake-Up by PCI card [Enabled]**
 This item allows user to enable and define how PCI cards to wake up the system from the suspend mode.
- **Power On by Ring [Enabled]**
 This item allows user to enable and define the system will resume by activating of modem ring.
- **Resume by Alarm [Disabled]**
 This item allows user to enable and key in the date and time to power on the system

Disabled	Disable this function.
Enabled	Enable alarm function to power on system
Day (of month) Alarm	1-31
Time (HH:MM:SS) Alarm	(0-23) : (0-59) : 0-59)

3.2.7 PnP/PCI Configurations

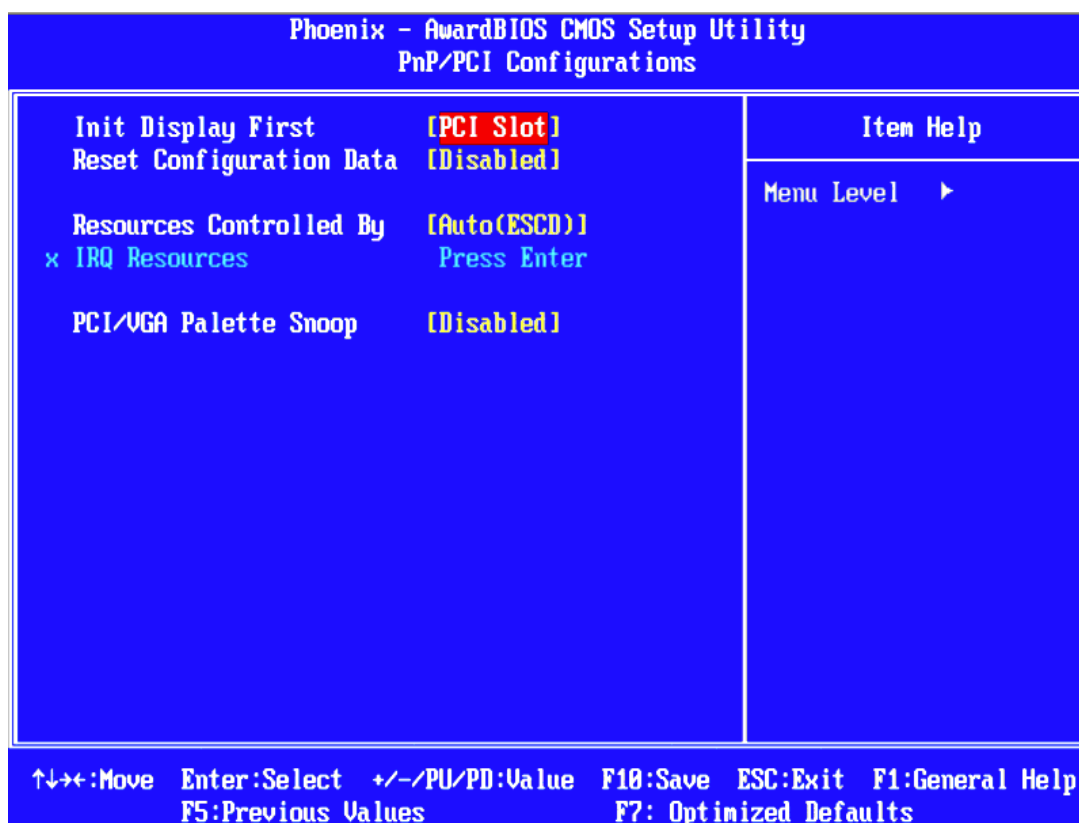

Note! This "PnP/PCI Configurations" option sets up the IRQ and DMA (both PnP and PCI bus assignments).



- **Init Display First** [PCI Slot]
This item is setting for start up Video output from PCI or Onboard device.
- **Reset Configuration Data** [Disabled]
This item allow user to clear any PnP configuration data stored in the BIOS.
- **Resources Controlled By** [Auto (ESCD)]
 - IRQ Resources
This item allows you respectively assign an interruptive type for IRQ-3, 4, 5, 7, 9, 10, 11, 12, 14, and 15.
 - DMA Resources
This item allows you respectively assign an interruptive type for DMA, 0, 1, 2, 3, 4, 5, 6, and 7.
- **PCI VGA Palette Snoop** [Disabled]
The item is designed to solve problems caused by some non-standard VGA cards. A built-in VGA system does not need this function.
- **INT Pin 1~8 Assignment**[°] [Auto]
This item allows the user to select the interrupt request (IRQ) assigned to a device connected to the PCI interface on your system.
- **Maximum Payload Size**[°] [4096]
This item allows the user to adjust maximum TLP (Transaction Layer Packet) payload size.

3.2.8 PC Health Status

Phoenix - AwardBIOS CMOS Setup Utility		Item Help
PC Health Status		Menu Level ▶
Shutdown Temperature	[Disabled]	
Current System Temp	56°C/132°F	
Current CPU1 Temperature	53°C/127°F	
Vcore	0.84V	
+2.5V	2.51V	
+3.3V	3.37V	
5 V	4.83V	
12 V	12.54V	

↑↓+←:Move Enter:Select +/-/PU/PD:Value F10:Save ESC:Exit F1:General Help
 F5:Previous Values F7: Optimized Defaults

Note! This "PC Health Status" page reports the thermal, fan and voltage status of the board. This page may vary according to the chipset installed.



- **Current CPU Temperature [Show Only]**
This item displays current CPU temperature.
- **FAN 1/FAN 2 Speed [Show Only]**
This item displays current system FAN(s) speed(s).
- **VCC/ 5 VTR/ 5V/ 12V [Show Only]**
This item displays current CPU and system voltage.

3.2.9 Frequency/Voltage Control

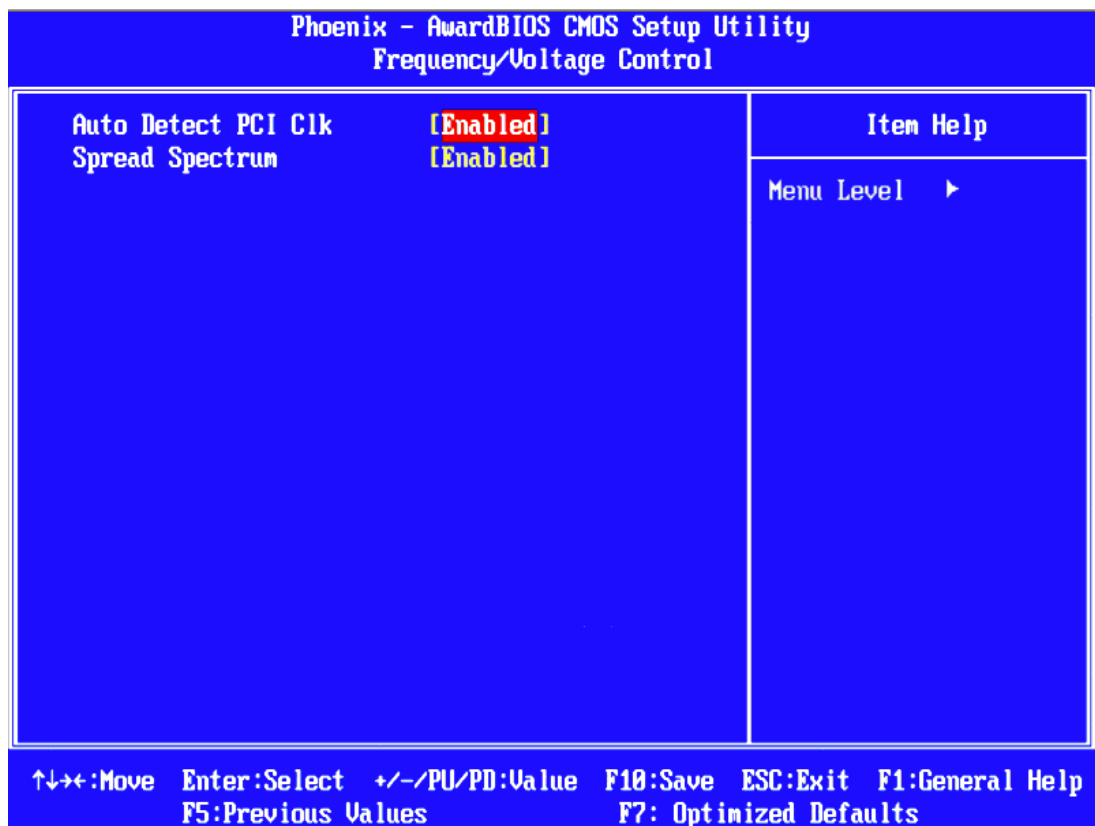

Note! *The "Frequency/Voltage Control" screen controls the CPU host and PCI frequency. The options on this page vary depending on the chipset; items show up according to installed CPU capacities.*



- **Auto Detect PCI Clk** [Enabled]
This item allows the user to set the PCI Clk either by automatic system detection or manually.
- **Spread Spectrum** [Disabled]
This item allows the user to set the spread spectrum modulation.

3.2.10 Load Optimized Defaults

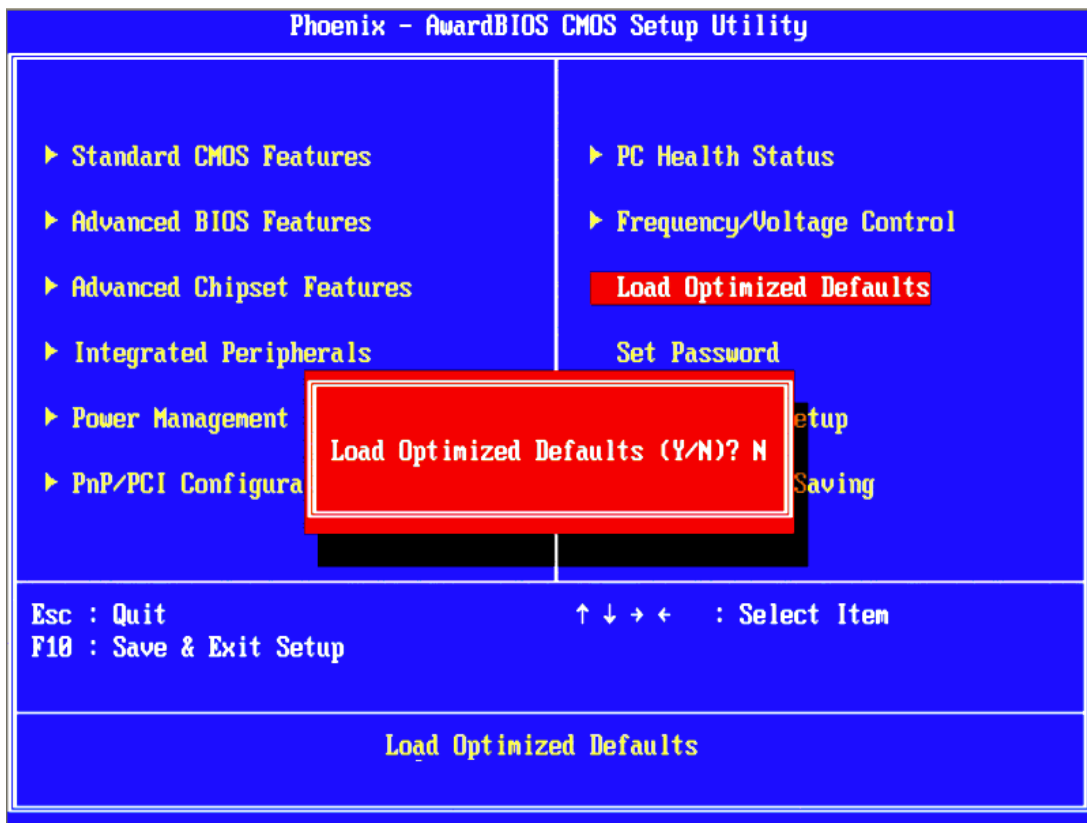

Note! *"Load Optimized Defaults" loads the default system values directly from ROM. If the stored record created by the setup program should ever become corrupted (and therefore unusable), select Load Setup Defaults to have these default values load automatically for the next bootup.*



3.2.11 Set Password

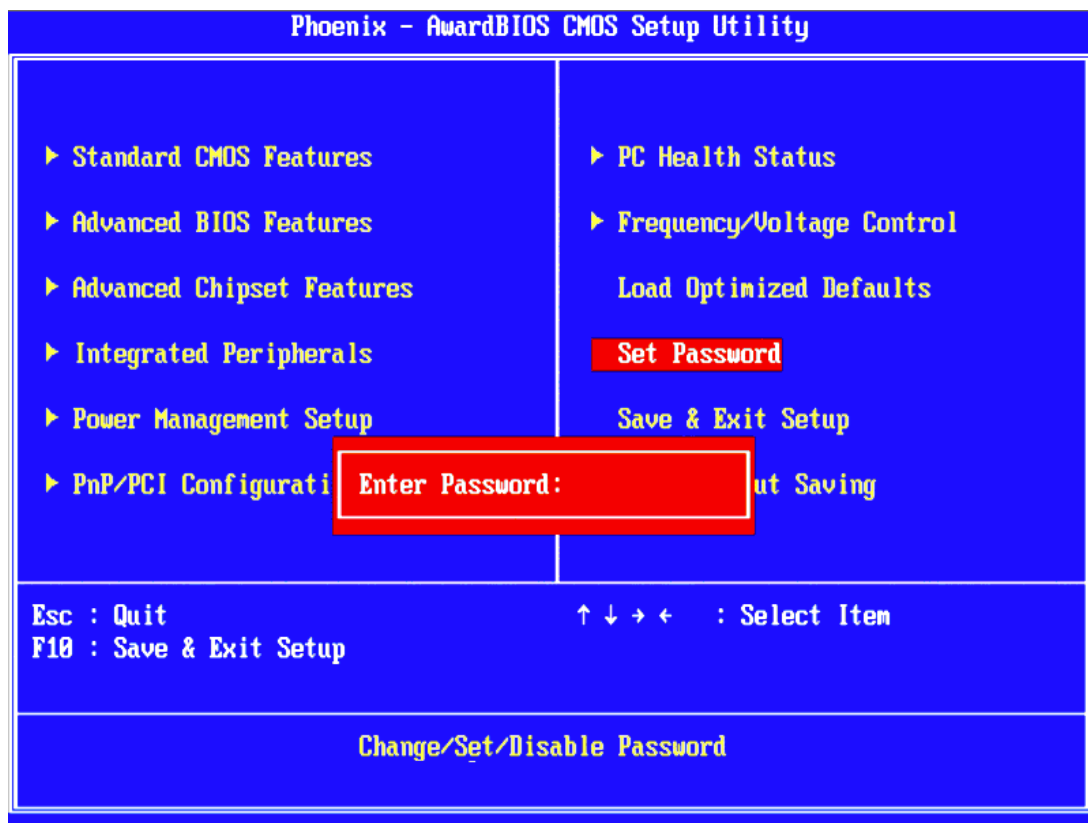

Note!  To enable this feature, you should first go to the "Advanced BIOS Features" menu, choose the Security Option, and select either System or Setup, depending on which aspects you want password protected. System requires a password both to boot the system and to enter Setup. Setup requires a password only to enter Setup. A password may be at most 8 characters long.

To Establish Password

1. Choose the **Set Password** option from the **CMOS Setup Utility** Main Menu and press <Enter>.
2. When you see **Enter Password**, enter the desired password and press <Enter>.
3. At the **Confirm Password** prompt, retype the desired password, then press <Enter>.
4. Select **Save to CMOS** and exit, type <Y>, then <Enter>.

To Change Password

1. Choose the **Set Password** option from the **CMOS Setup Utility** main menu and press <Enter>.
2. When you see **Enter Password**, enter the existing password and press <Enter>.
3. You will see the **Confirm Password** prompt, type it in again, and press <Enter>.
4. Select **Set Password** again, and at the **Enter Password** prompt, enter the new password and press <Enter>.

5. At the **Confirm Password** prompt, retype the new password, and press <Enter>.
6. Select **Save to CMOS** and exit, type <Y>, then <Enter>.

To Disable a Password

1. Choose the **Set Password** option from the **CMOS Setup Utility** main menu and press <Enter>.
2. When you see the **Enter Password** prompt, enter the existing password and press <Enter>.
3. You will see **Confirm Password**, type it in again, and press <Enter>.
4. Select **Set Password** again, and at the **Enter Password** prompt, DO NOT enter anything - just press <Enter>.
5. At the **Confirm Password** prompt, again, DO NOT type in anything - just press <Enter>.
6. Select **Save to CMOS** and exit, type <Y>, then <Enter>.

3.2.12 Save & Exit Setup

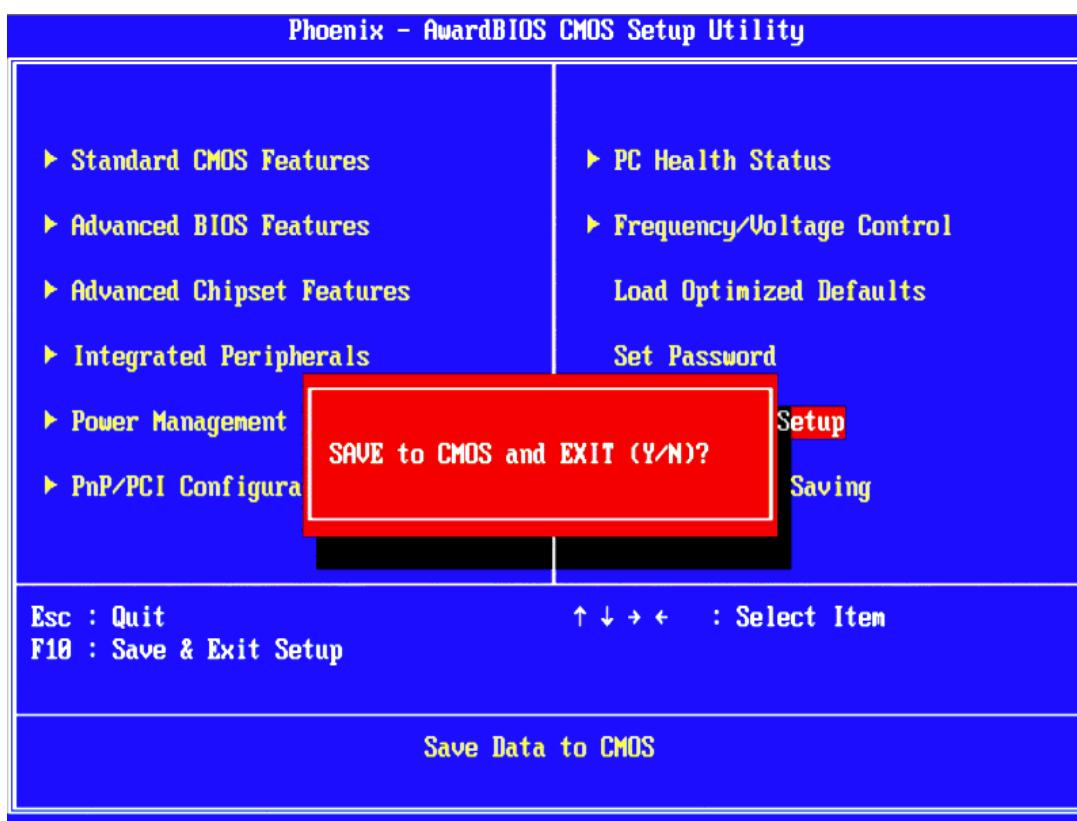

Note! Typing "Y" will quit the BIOS Setup Utility and save user setup values to CMOS.
 Typing "N" will return to BIOS Setup Utility.



3.2.13 Quit Without Saving

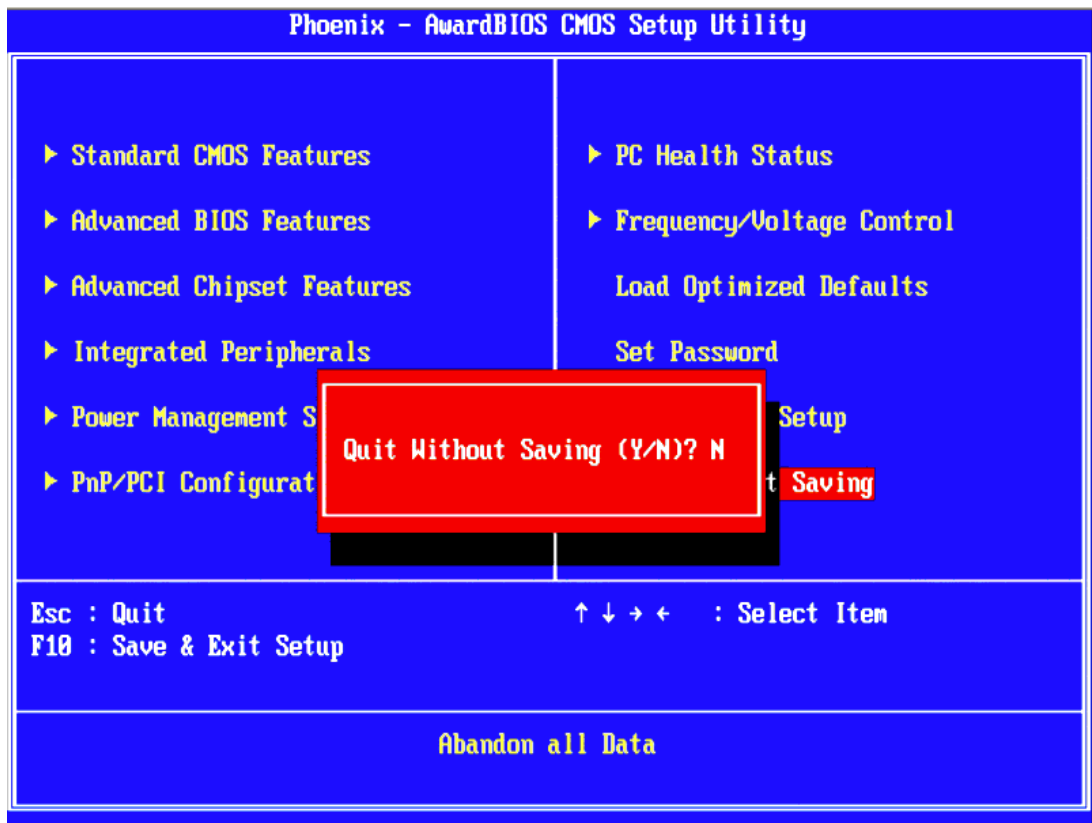

Note! Typing "Y" will quit the BIOS Setup Utility without saving any changes to CMOS.



Typing "N" will return to the BIOS Setup Utility.

Chapter 4

In-vehicle power
setting

All the in-vehicle installed systems require a sophisticated power management. The new Advantech solution based on the Box IPC ARK-1388V designed especially for in-vehicle applications offers due to its outstanding hardware and firmware design in microcontroller based safe boot and safe shut down functions. The rugged industrial PC works with both 12 volt and 24 volt battery systems. The innovative power management system is dedicated primarily for taxicabs, trucks, wagons, mining, and city buses. This chapter will introduce how to setting the relative parameter of the power management system.

4.1 Power mode selection

ARK-1388V can work as a normal Box IPC or in-vehicle Box IPC. But the power solution of these two applications is quite different. The connector CN18 is designed for selecting whether the power input is in-vehicle power or not. If the two pins of CN18 are leaved open without any jumper on it, then ARK-1388V will work as an in-vehicle Box IPC. Its power management firmware design in PIC microcontroller will start to work.

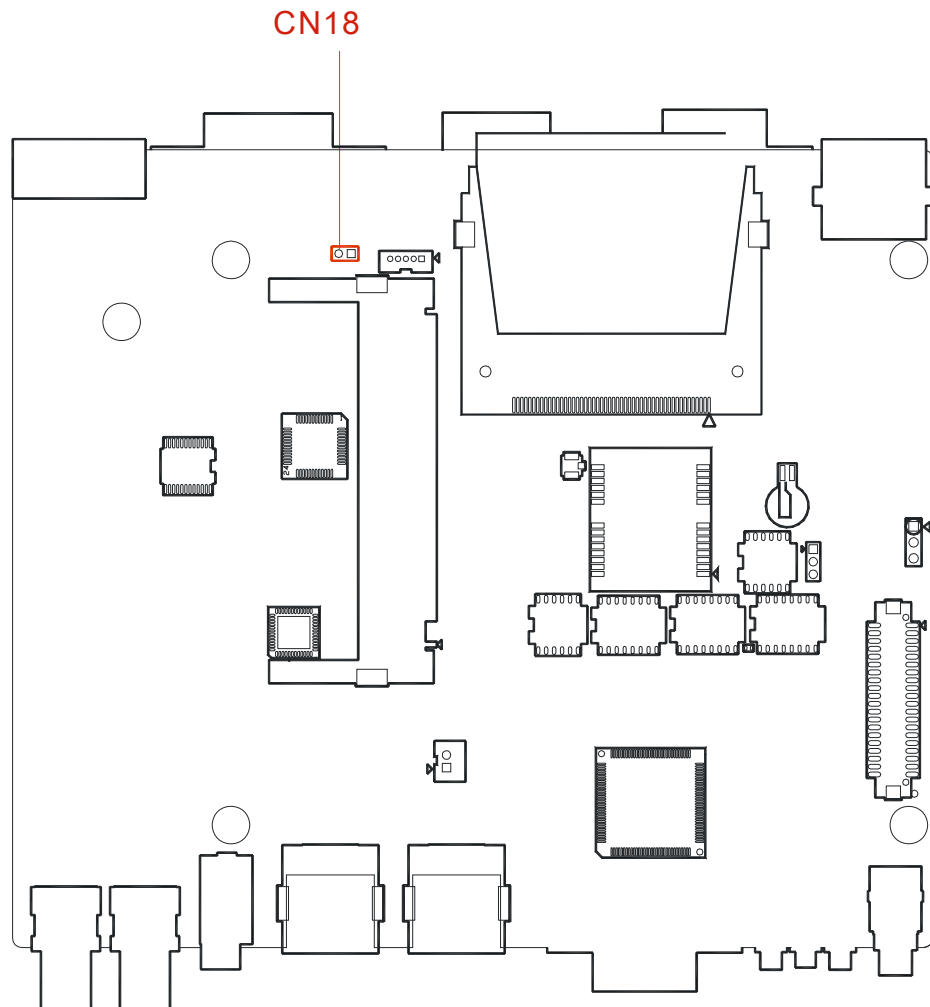

Figure 4.1 The jumper location for power mode selection (CN18)

4.2 Turn on procedure of PIC firmware

If the power mode of the ARK-1388V is set as general purpose IPC mode, the system will turn on when the power button pushed and power input is live. When the power mode of the ARK-1388V is set as in-vehicle mode, the turn on and turn off procedure will be controlled by PIC firmware. The turn on procedure of PIC firmware is shown in Fig 4.2. Firstly, the PIC firmware will automatically check the voltage level of the input battery power. Then it will check the battery status. The battery status is normal if the input voltage is higher than 11V in a 12V system or 22V in a 24V system. Next, the IGN status is determined by the voltage level of ignition signal which is located at the third pin of power connector. If the voltage of IGN is higher than 8V, the IGN status is high. The system will be turned on after 10 seconds, named turn-on delay, if the IGN status is higher.

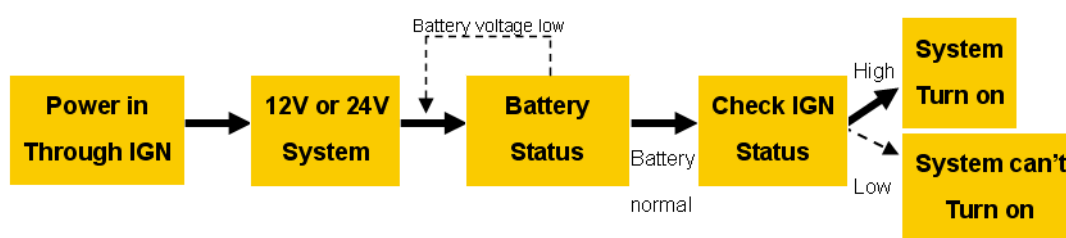

Figure 4.2 Turn on procedure of PIC firmware

4.3 Turn off procedure of PIC firmware

ARK-1388V will start to shut down if the IGN signal goes lower than 8V. Then the system will turn off after the time period named off delay. The off delay time is used for an in-vehicle device, ARK-1388V, to store information or communicate with a device on stations before it turns off. If the system hangs when shutting down or is still alive longer than the time period named in hard off, then PIC firmware will force the system to shut down right away to avoid consuming the battery power. The time period of off delay and hard off can be set by the 4th to 6th pins on SW6. For more timing details on the 4th to 6th pins on SW6, please refer to Table 2.9.

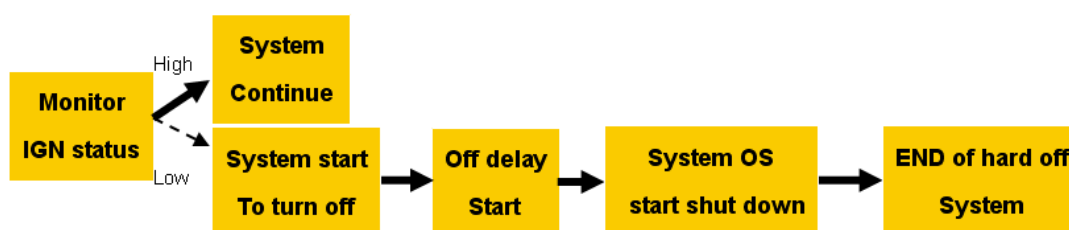

Figure 4.3 Turn off procedure of PIC firmware

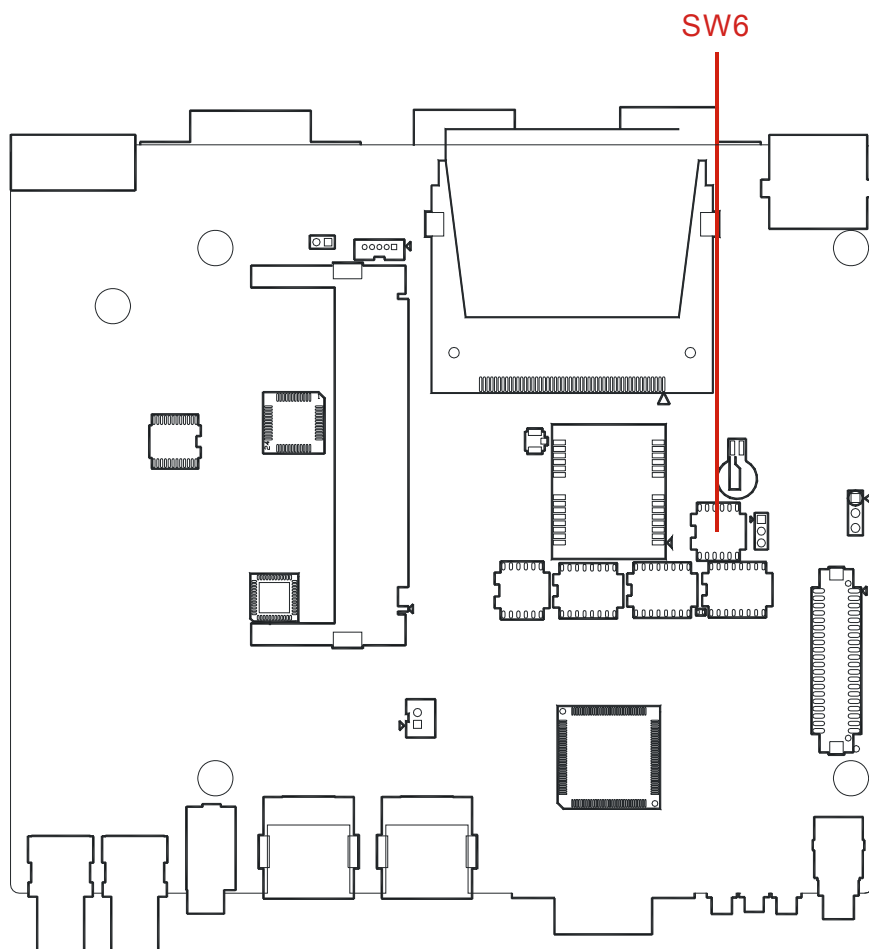

Figure 4.4 The switch location for off delay and hard off setting (SW6)

4.4 Battery Status Checking

The PIC firmware of ARK-1388V will keep detecting and monitoring the battery voltage of the power input when the system is operating. If it detects the battery voltage level is lower than 11V in a 12V system or 22V in a 24V system, ARK-1388V will be shut down with 5 seconds delay. Battery status checking can make sure the battery will not be run down by ARK-1388V. Similarly, in the turn off procedure, the system will start hard off shutdown if the system doesn't shut down within the time limit specified as hard off.

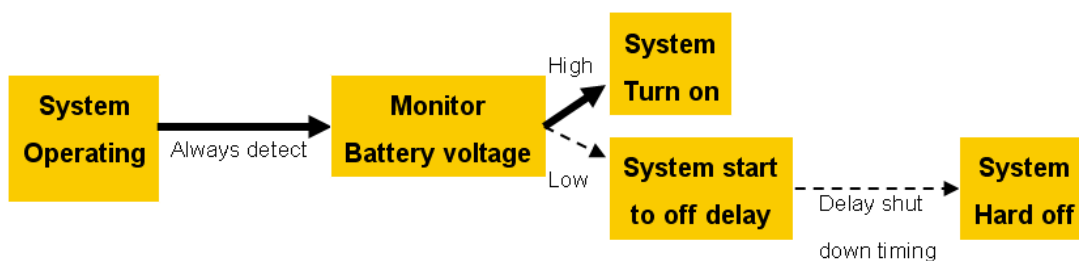

Figure 4.5 Battery status checking of PIC firmware

Chapter 5

Extension I/O
Installation

5.1 AMO-Module

ARK-1388V supports internal expansion connector which is USB signal to connect with AMO-EDGE (9796138800E) or AMO-HSDPA (9796138801E) module. We strongly suggest you that it should be installed by Advantech CTOS team because great care is required when connecting with I-PEX cable.

5.1.1 AMO-EDGE (9796138800E)

AMO-EDGE includes a PCB base board, Wavecom Q2687 module, an external quad band 850/900/1800/1900 SMA M. Antenna. (P/N:1750002840) and a GPRS setting cable (P/N: 1700012554)

Table 5.1: AMO-EDGE connect list

CN	connector name
1	SIM holder
2	system connector (To connect with Wavecom module)
3	GPRS/EDGE module connector (To connect with ARK-1388V base board)
4	Programmable connector (To connect with cable P/N: 1700012554)

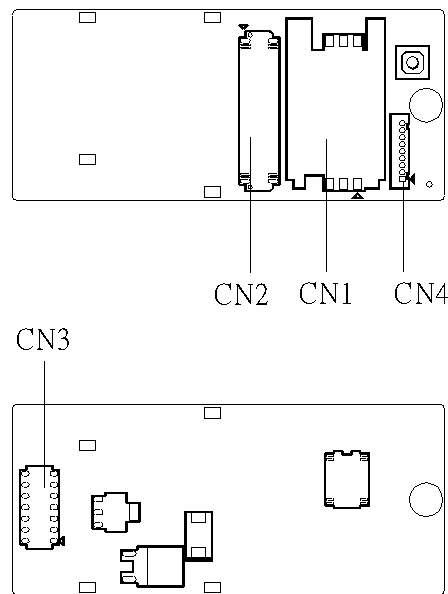

Figure 5.1 AMO-EDGE base board

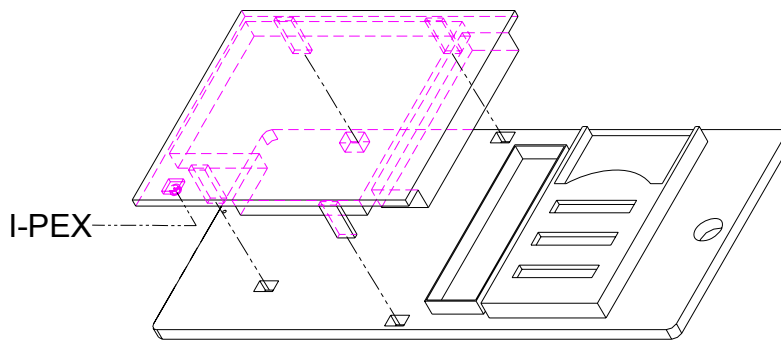

Figure 5.2 Install Wavecom module on AMO base board

5.1.1.1 Mounting Wavecom module to the AMO base board

The antenna may be connected to the wavecom module via the UFL connector pre-set as the below red mark place.

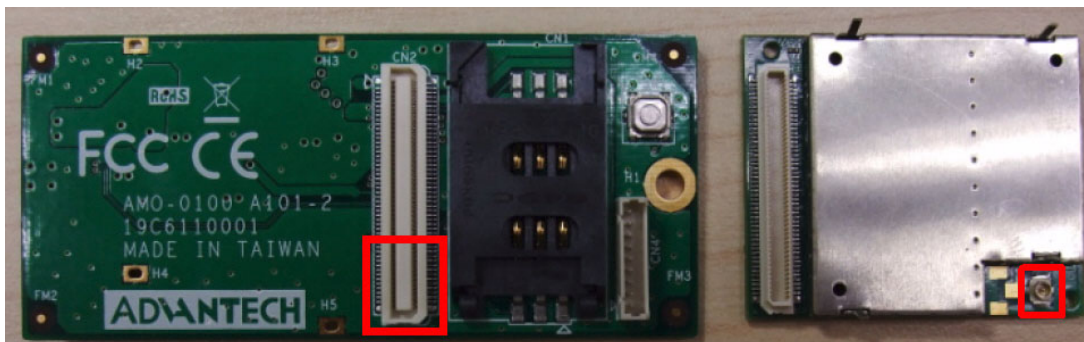

Figure 5.3 AMO-EDGE base board and wavecom module

This step is done prior to the wavecom module being mounted on AMO-EDGE base board. Unscrew the top cover on ARK-1388V and you will see the internal SMA cable as per Figure 5.4.



Figure 5.4 GPRS/EDGE SMA cable internally

The SMA cable should be connected to Wavecom module.

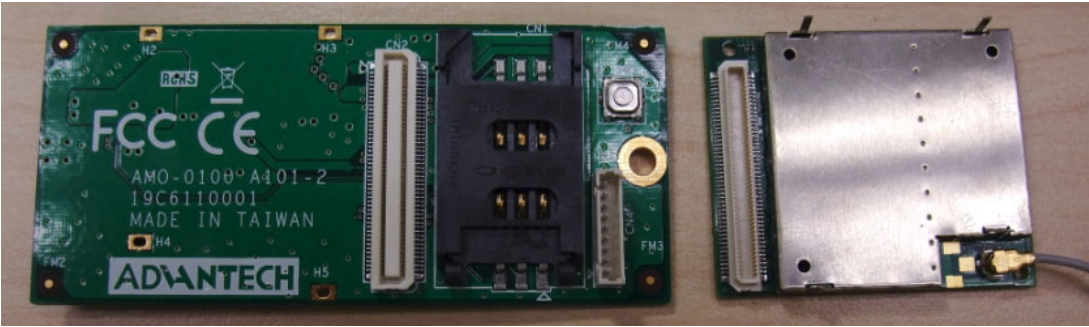

Figure 5.5 Wavecom UFL/SMA connector

When installing the module into the base board, please make sure the module is connected with system connector and the ground pin is inserted into the four holes as marked below in red. It is highly recommended to solder the four ground pins.

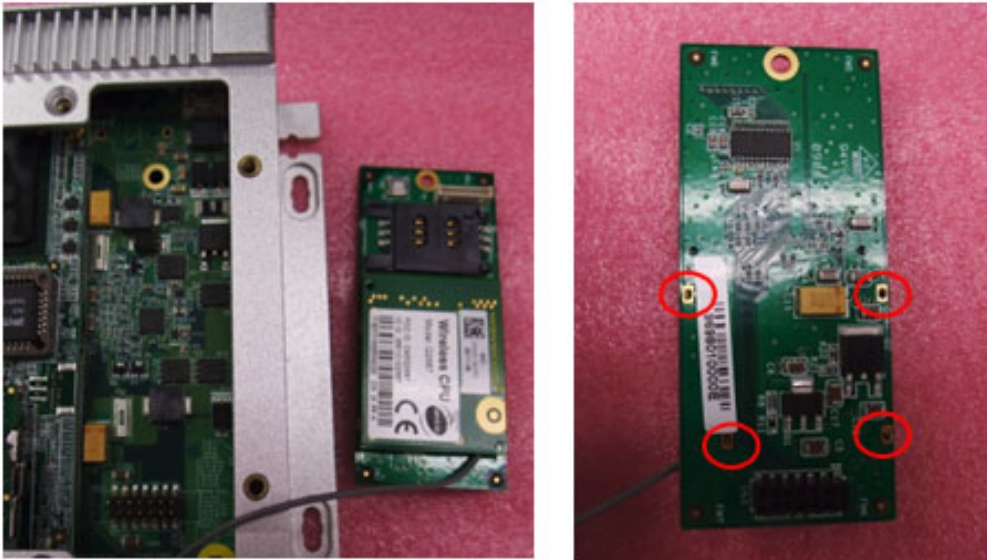

Figure 5.6 Mounting wavecom on AMO base board

Plug AMO-EDGE bottom CN3 into the ARK-1388V CN23 and attach with a screw M2.5*5L from the package. This finishes the installation of AMO-EDGE. Then complete reassembly.



Figure 5.7 Installation AMO-EDGE on ARK-1388V

5.1.2 AMO-HSDPA (9796138801E)

5.1.2.1 AMO-HSDPA

AMO-HSDPA includes a PCB base board, Siemens HC25 module, an external 850/900/1800/1900/2100 SMA M. Antenna. (P/N:1750004421).

Table 5.2: AMO-HSDPA connect list

CN	connector name
1	SIM holder
2	system connector (To connect with Siemens module)
3	UMTS/HSDPA module connector (To connect with ARK-1388V base board)

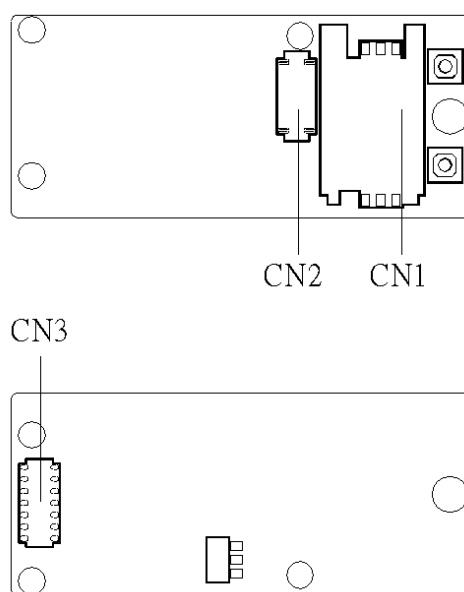

Figure 5.8 AMO-HSDPA board

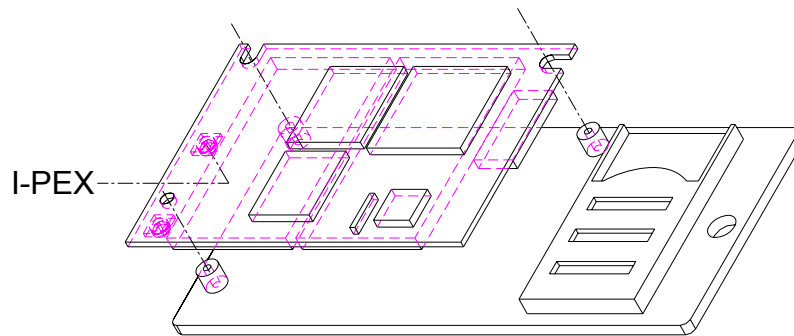

Figure 5.9 install Siemens module on AMO board

5.1.2.2 Mounting Siemens module to the AMO base board

The antenna may be connected to the RF antenna connector of a Siemens module.

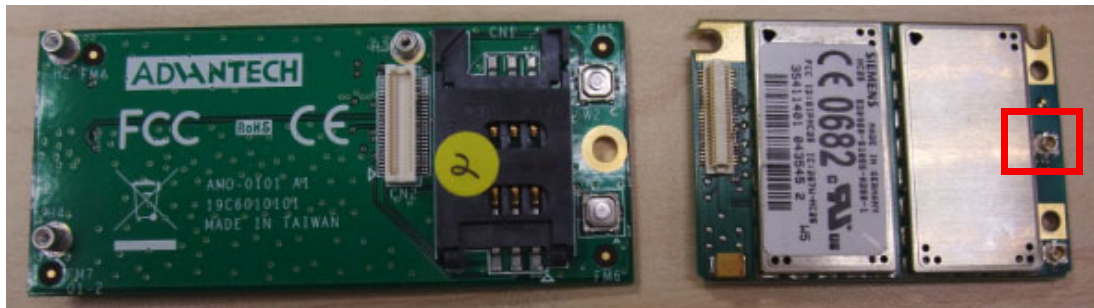

Figure 5.10 AMO-EDGE base board and Siemens module

This step is done prior to the Siemens module mounting on AMO-HSDPA base board. Unscrew the top cover on ARK-1388V and you will see there is one internal SMA cable as Figure 5.11.



Figure 5.11 UMTS/HSDPA SMA cable internally

The SMA cable is connected to the Siemens module.



Figure 5.12 Siemens antenna connector

When installing the module into the base board, Plug AMO-HSDPA bottom side CN3 into the ARK-1388V CN23 and attach with a screw M2.5*5L from the package. Please make sure the module is connected with system connector and fasten the M2 screws in the three holes

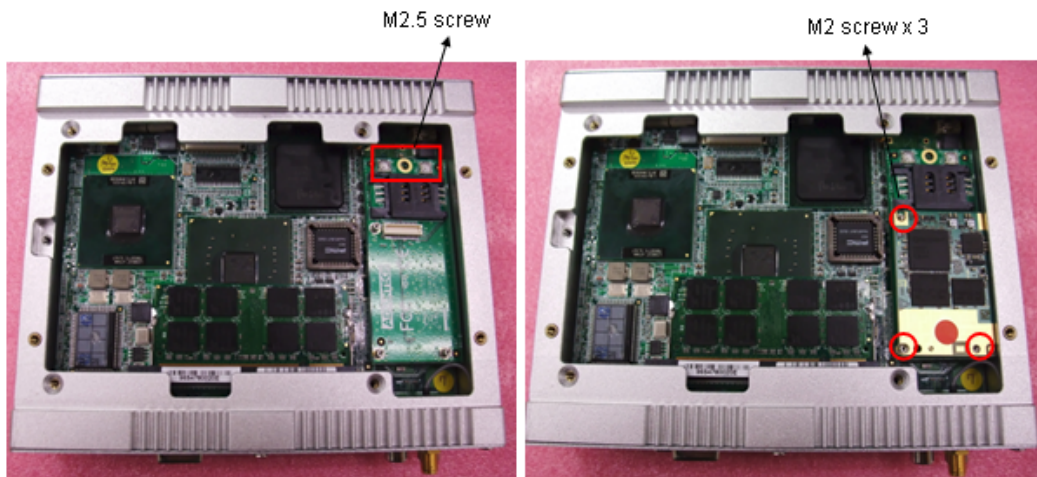

Figure 5.13 Installation AMO-HSDPA on ARK-1388V

Chapter 6

Full Disassembly
Procedure

6.1 Full disassembly procedure

If you want to completely disassemble ARK-1388V, follow the step-by-step procedures below. Users should be aware that Advantech Co., Ltd. takes no responsibility whatsoever for any problems or damage caused by the user disassembly of ARK-1388V. Make sure the power cord of ARK-1388V is unplugged before you start disassembly.

1. Unscrew the four screws on the top.

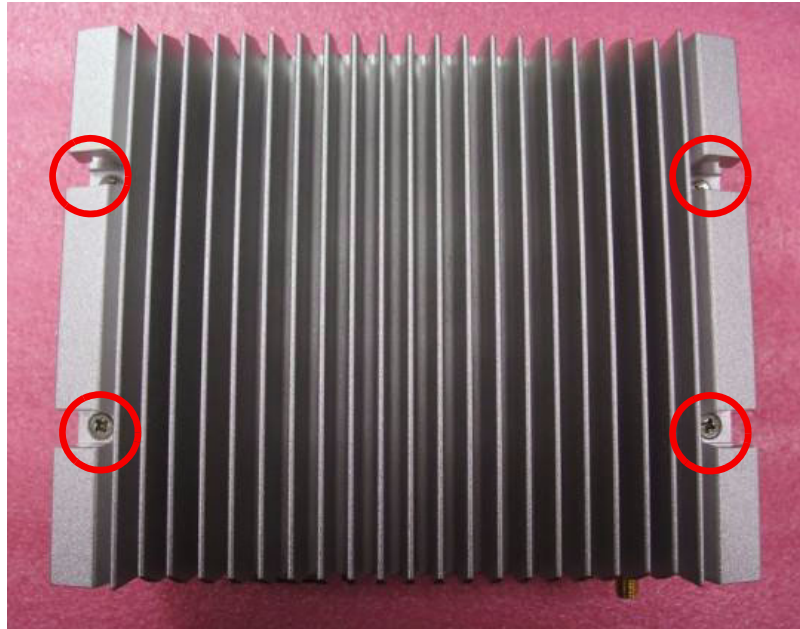

2. Take out the top cover

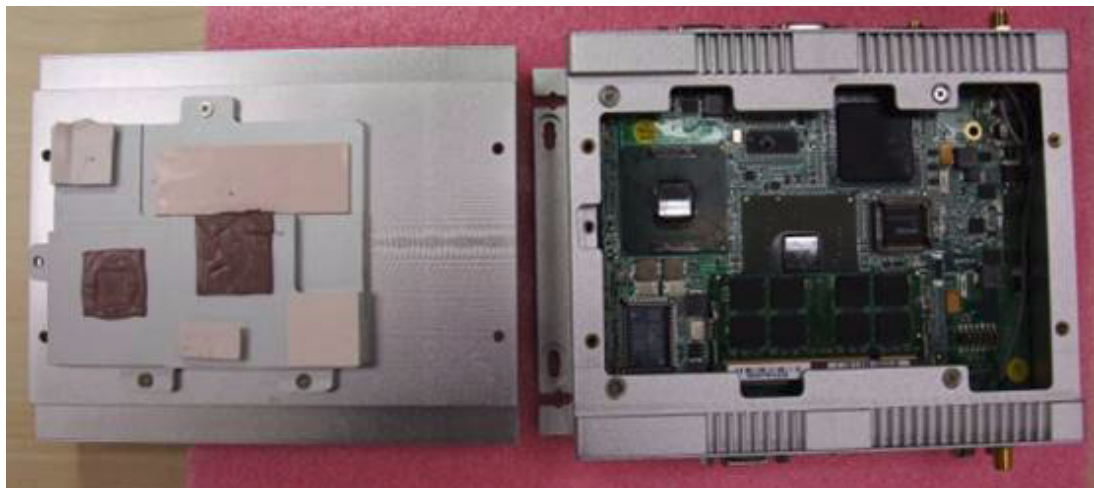

3. Unscrew the 6 edge screws on the front panel.



4. Unscrew the screws in the middle of the front panel

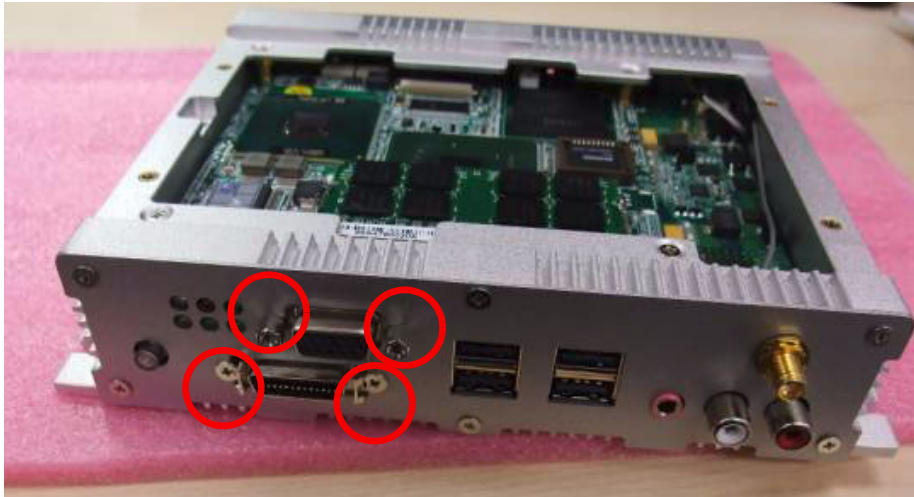

5. Please be careful take off the internal SMA Cable before taking out the front plate.

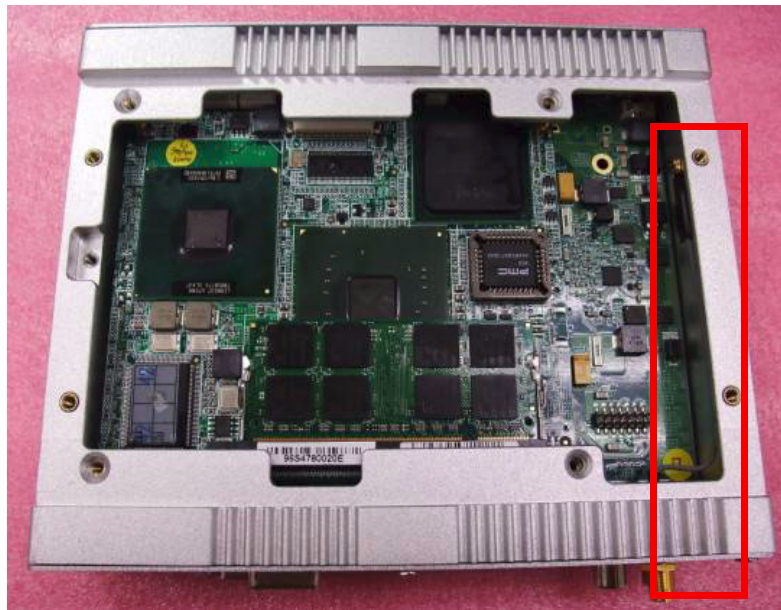

6. Unscrew the four screws.



7. Unscrew the six edge screws on the rear panel.



8. Unscrew the screws and hex-bolts in the middle of the rear panel.

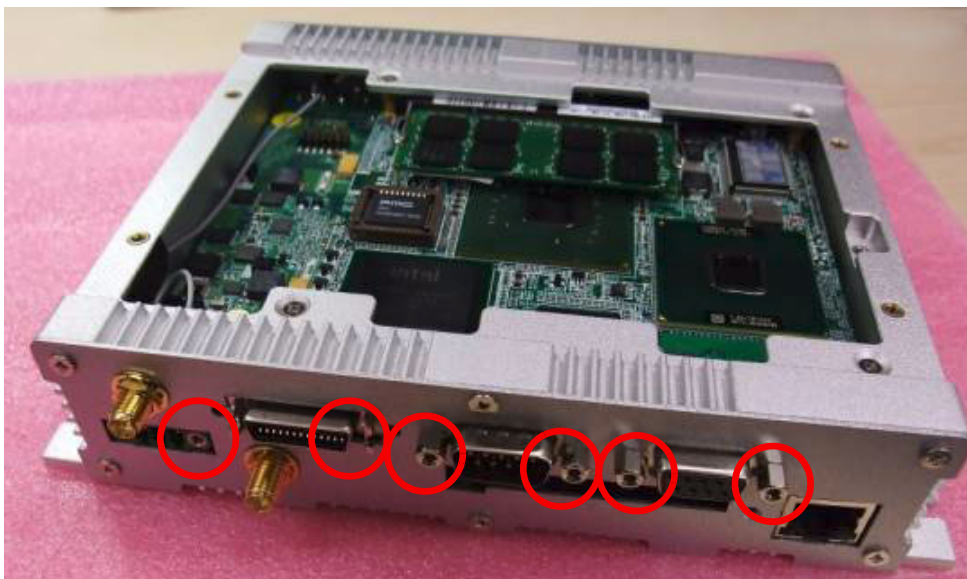

9. Pull the carrier board out keeping the SMA cables on the plate

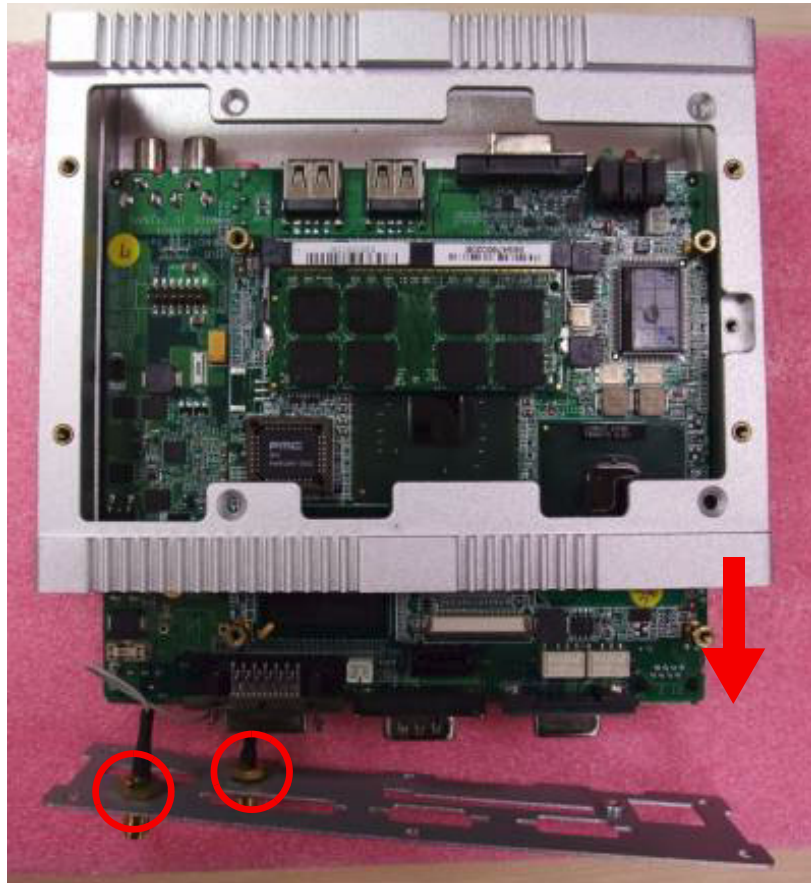

10. Take off the internal cable connector from the WLAN module and GPS antenna connector.



11. Finished disassembly of the system



6.2 Full assembly procedure

1. Connect the WLAN and GPS internal SMA cable on board first. Please be noted that WLAN SMA connector is Male type and GPS SMA connector is Female type.



2. Insert the board on top side and screw the four screws on top side.

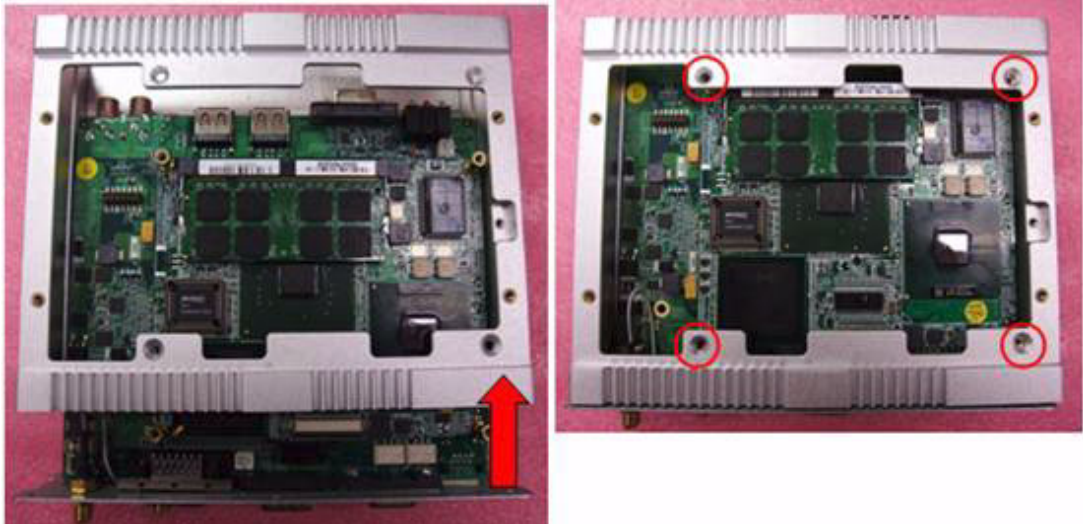

3. Screws the screws on the rear plate.

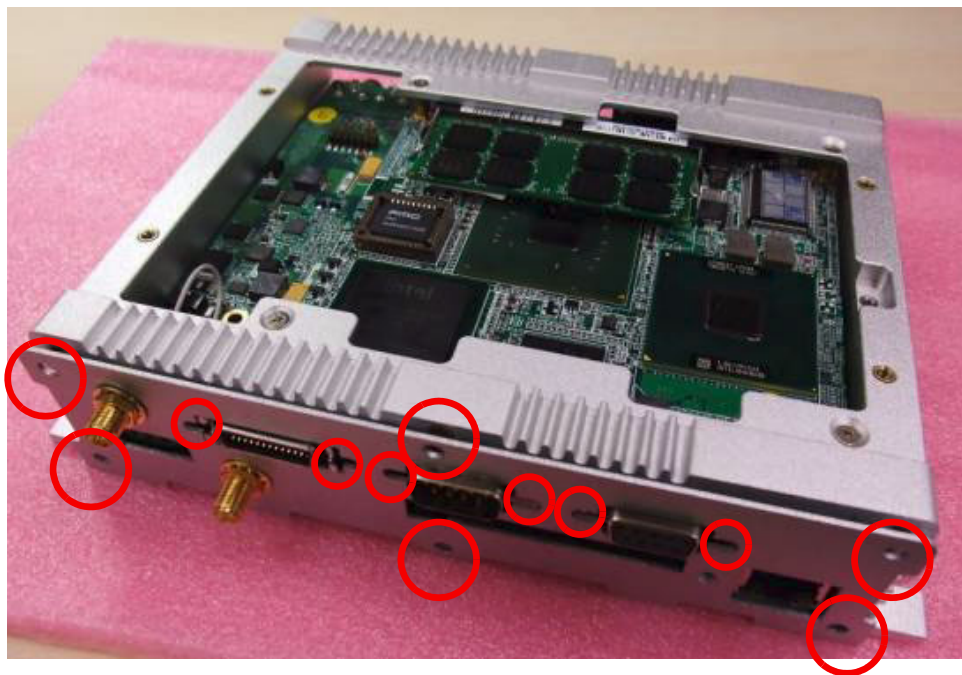

4. Assemble the front panel with the SMA cable is already fixed on the plate.



5. Put on the front IO plate and screw in the LVDS connector first, then put in the screws on the front plate



- LVDS is cable type so hold the LVDS connector together with the front IO plate and attach with screws.

6. Install AMO module (refer to CH5) and make sure the thermal pad is not damaged on heat spreader.



7. Screw the four screws on Top cover. This finishes the assembly process.

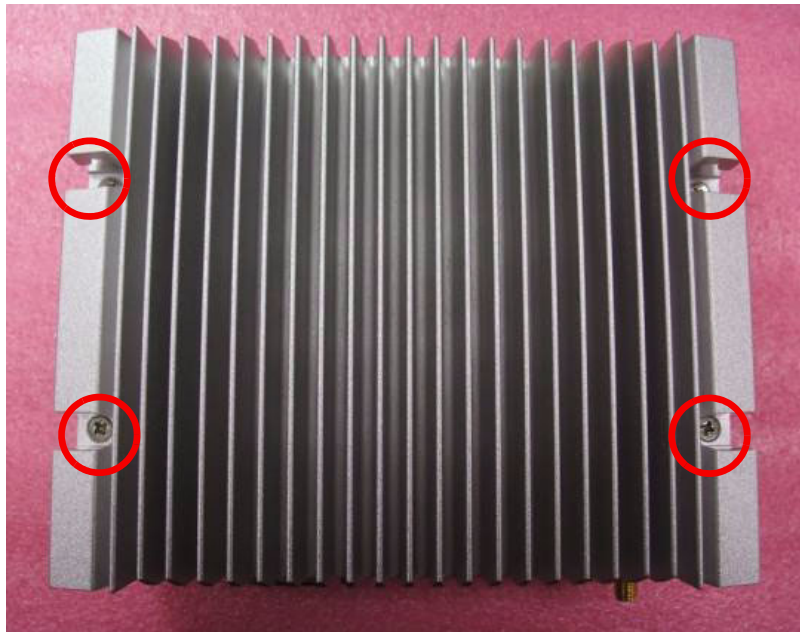

Appendix **A**

GPS test Setting Guide

A.1 GPS test Setting Guide

1. A simple way to check the GPS function is to use Hyper Terminal.
2. Please follow the figure below to add a new Hyper Terminal setting.

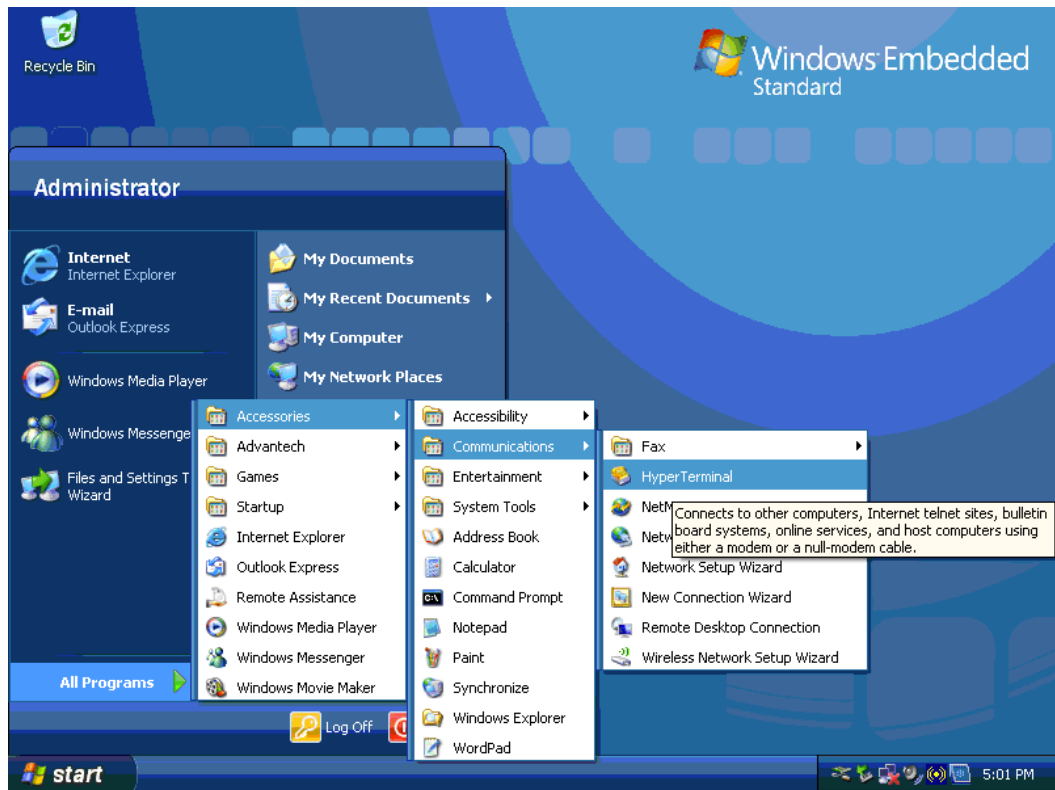

3. Please select "Yes".

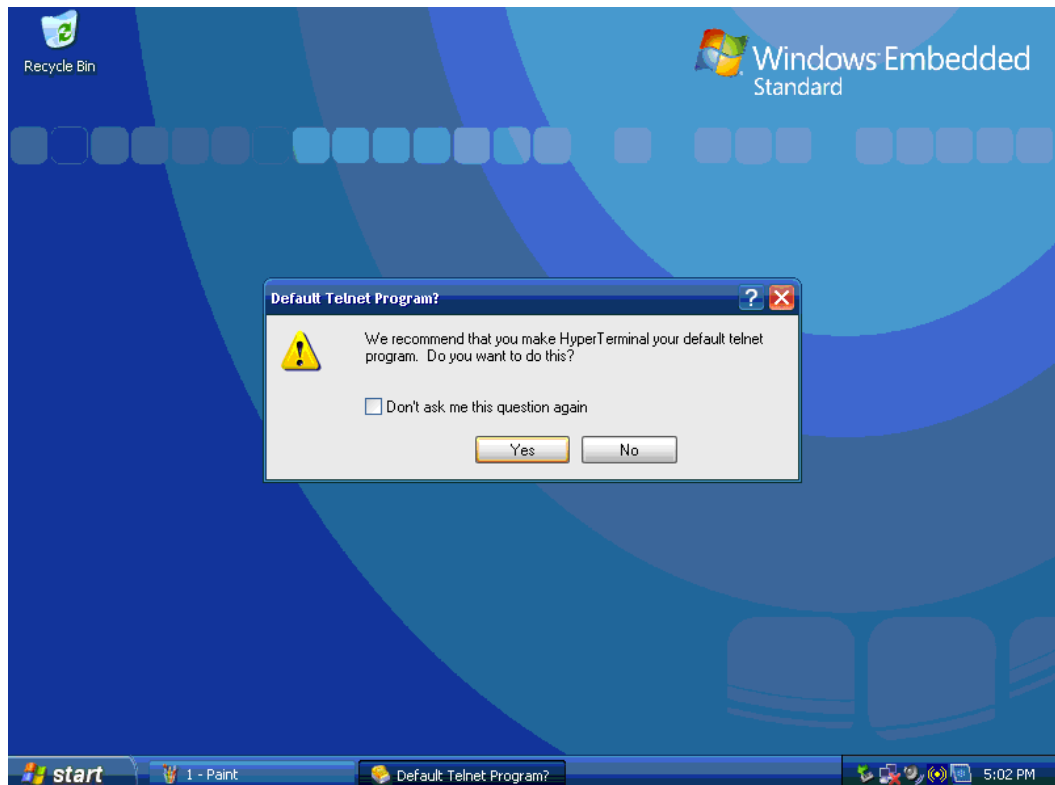

- Please select the country and key-in area code for your country as in the figure below, e.g., Taiwan is 886.

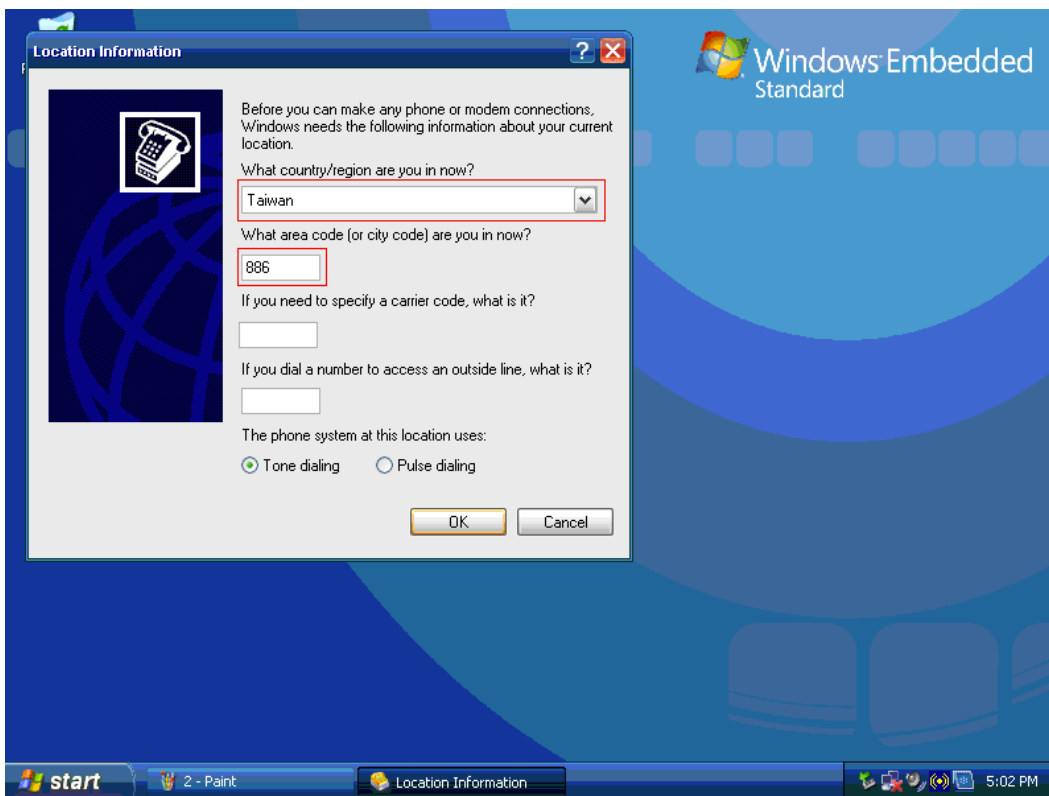

- Please Key-In any description name to build the setting, for this example we use GPS.

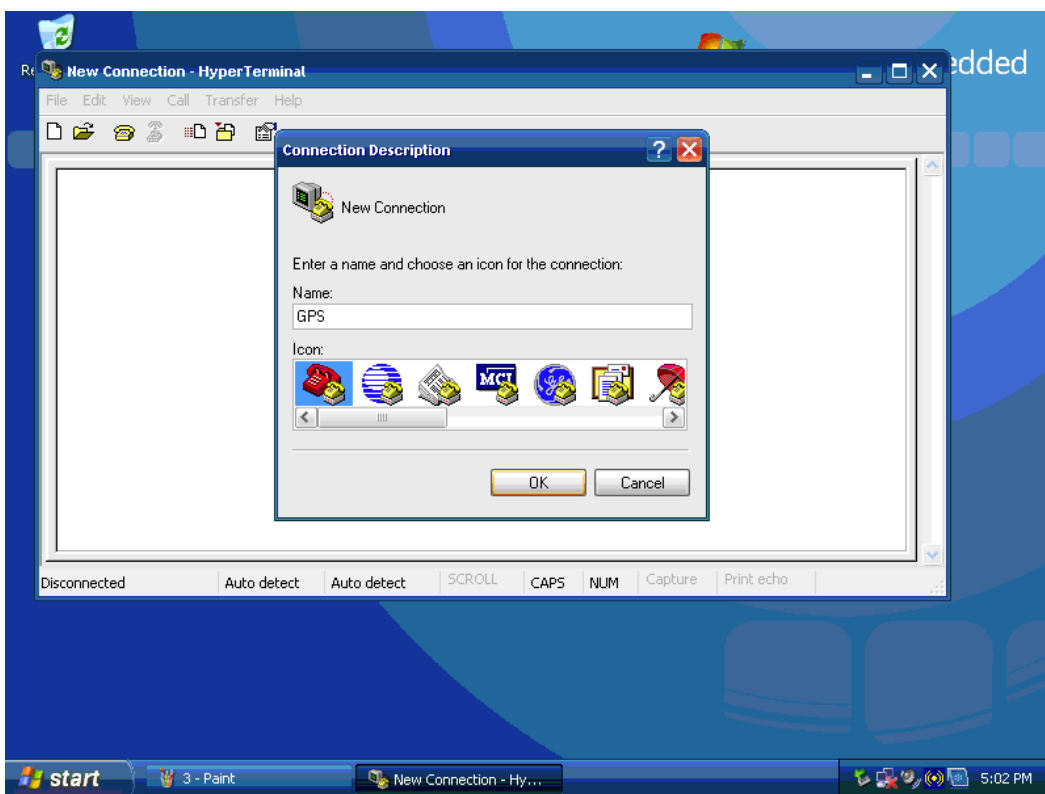

- Please select "COM5", The GPS Module on ARK-1388V uses COM5.

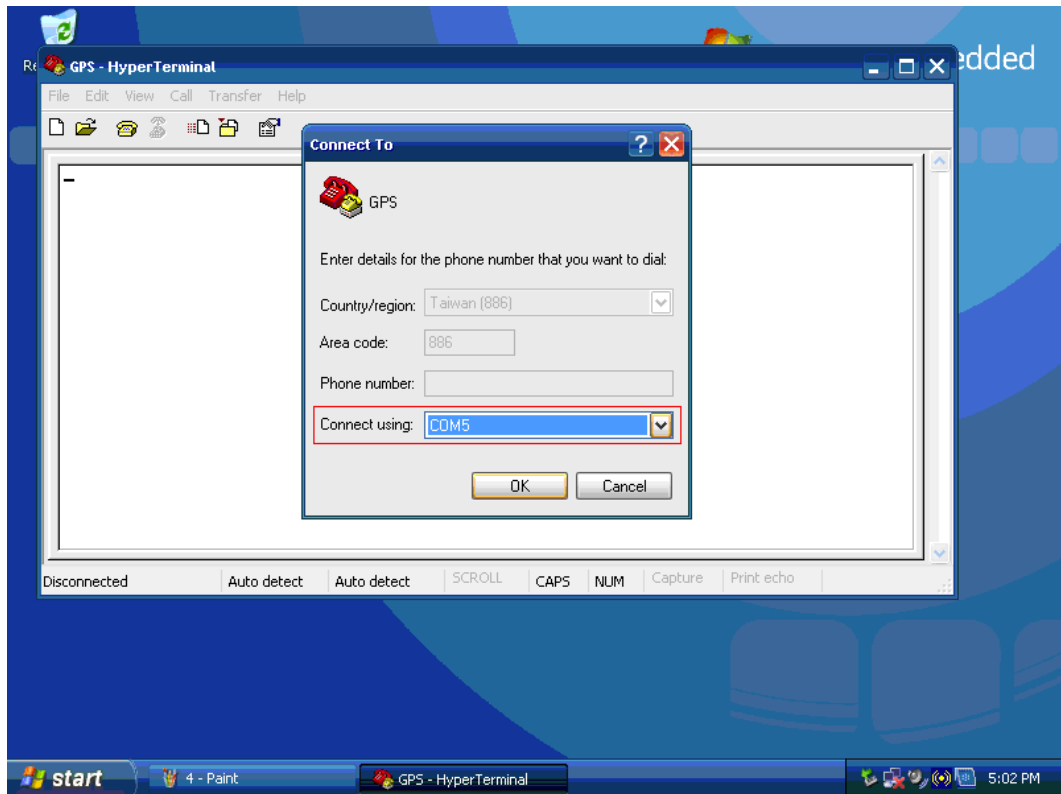

- Please set the item of "Bits per second" to "9600"; the GPS Module on ARK-1388V uses 9600, "Flow control" set to "None".

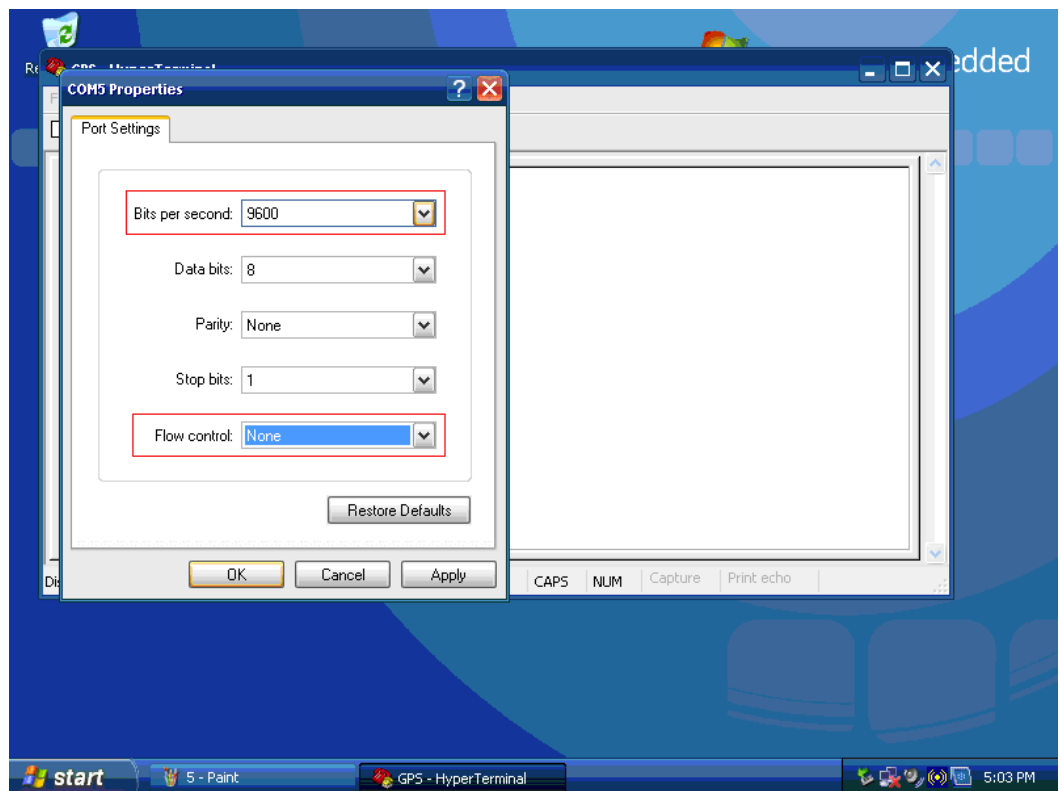

- 8. After making settings, you can see the Hyper Terminal window receive the information from GPS if setup successfully.

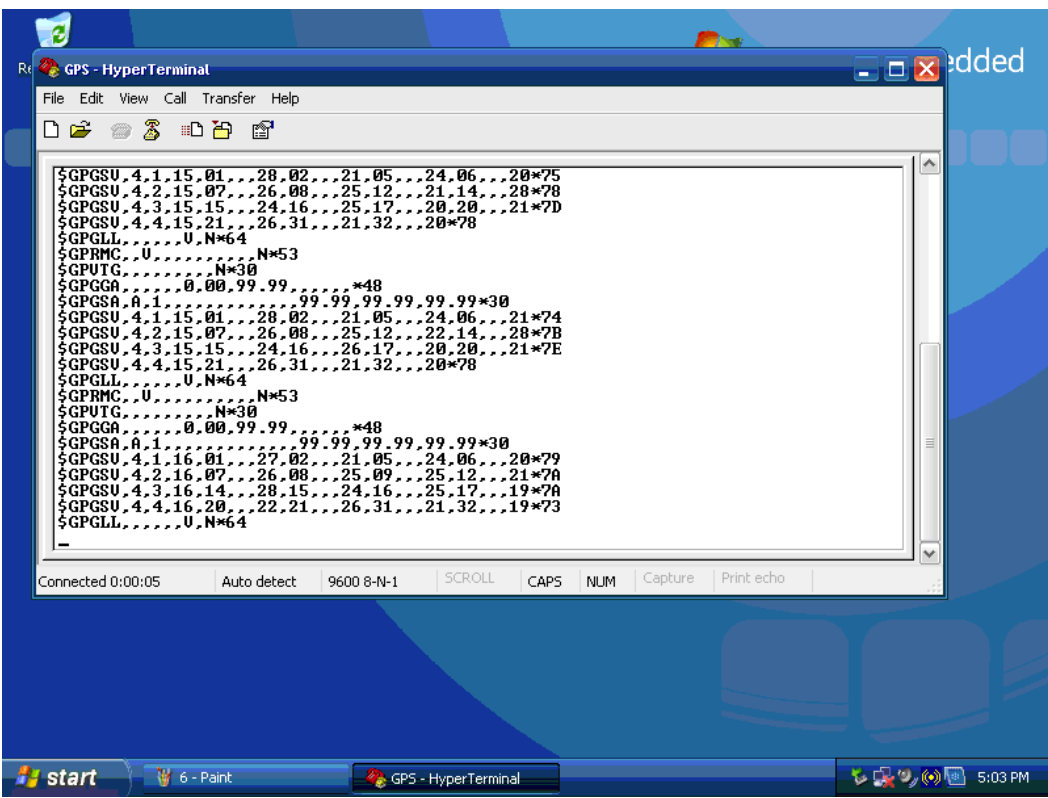

- 9. Please store your Hyper Terminal setting and create the path on your desktop for testing.

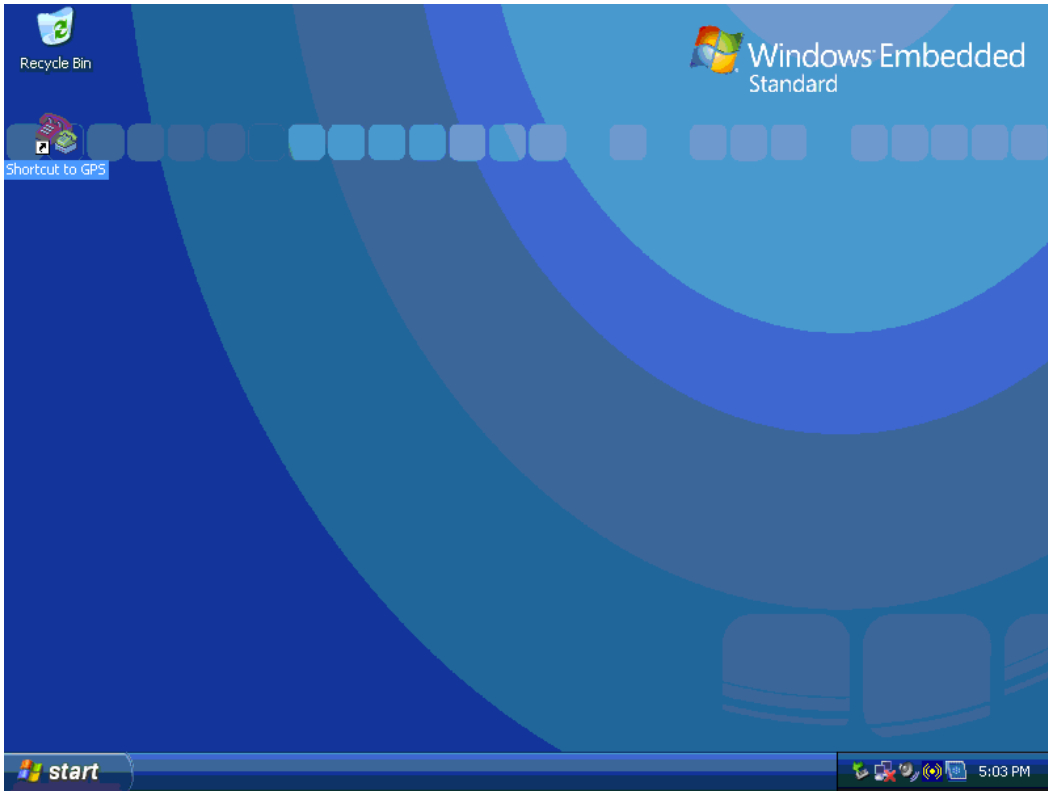

Appendix **B**

AMO-EDGE GPRS
Module (Q2687) Board
Settings

B.1 AMO-EDGE GPRS Module (Q2687) Board Setting

1. After boot up and driver installation, you will find "Wavecom USB modem" on Device Manager. Check the Wavecom USB modem

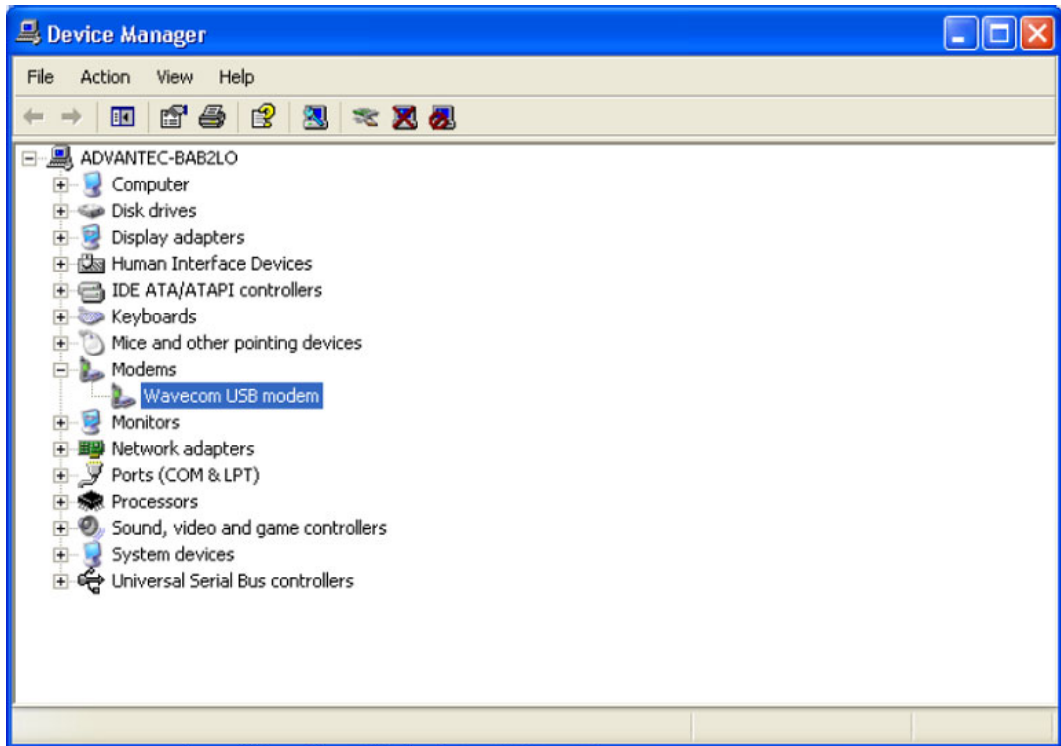

2. Click modem and make sure of the related settings; and adjust the "max port speed" to 115200.

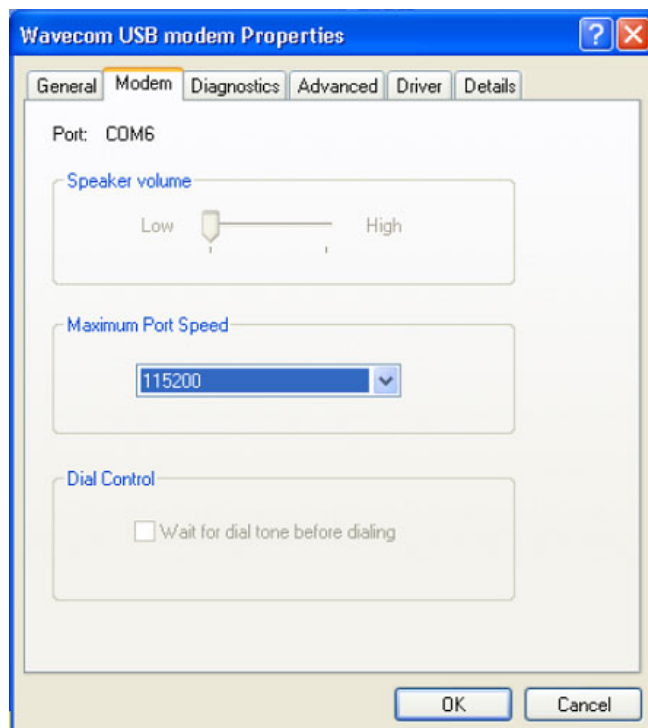

3. Check the modem status on diagnostic item.

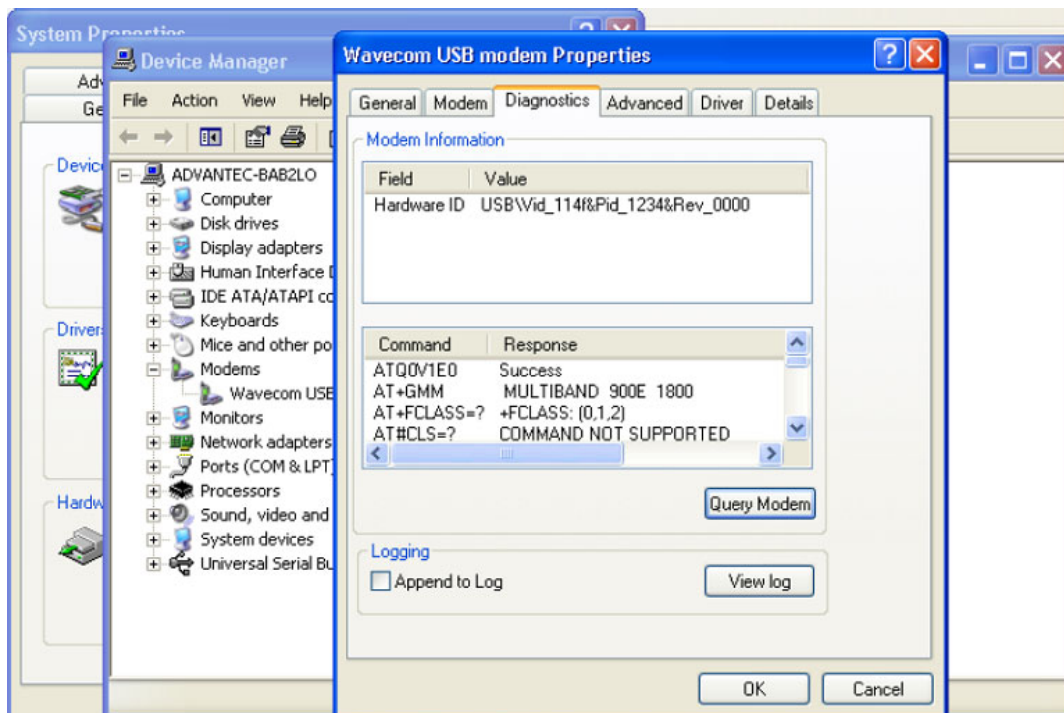

4. Add one new hyper terminal, and select COM number as COM6. The GPRS Module on ARK-1388V works via COM6.

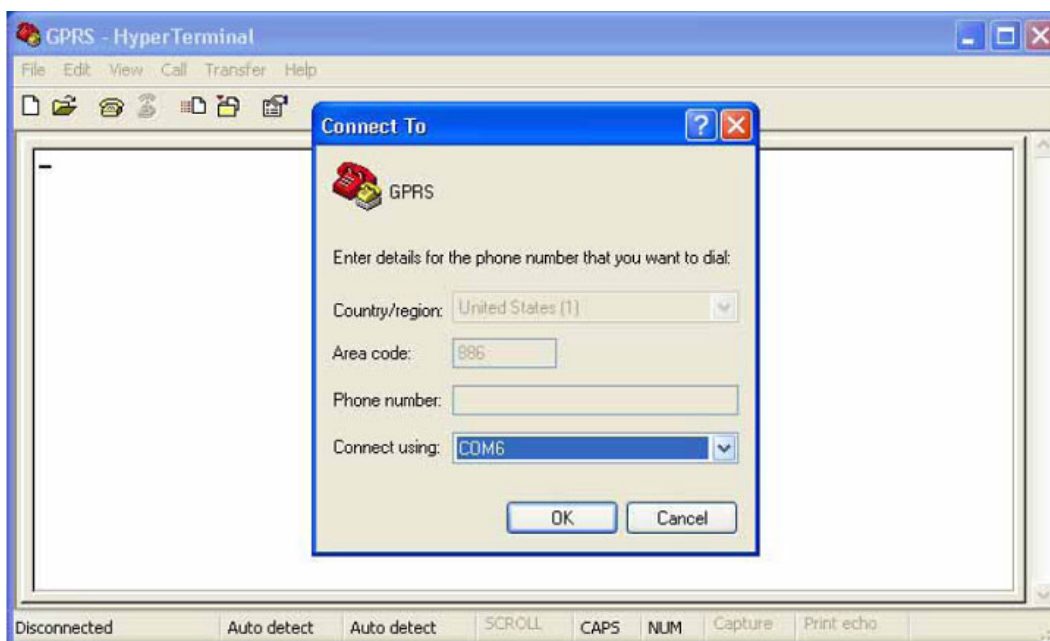

5. Set the COM6 properties as below.

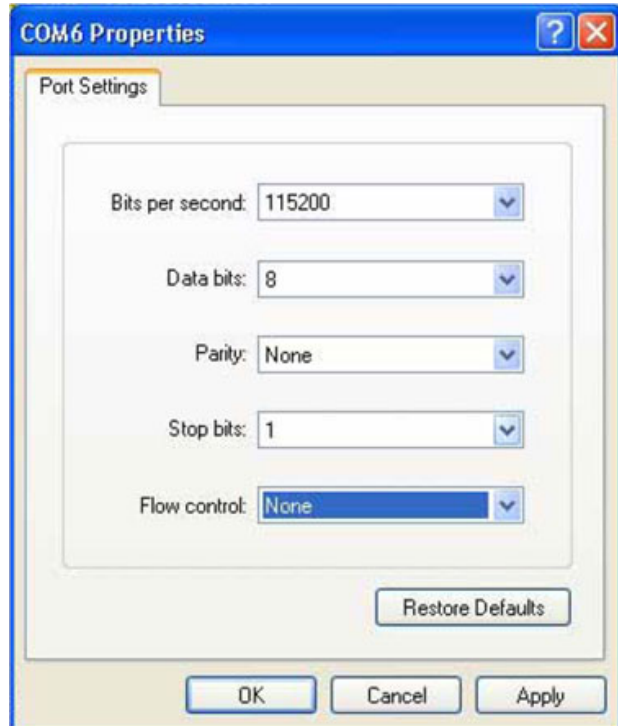

6. Execute the commands below in hyper terminal to check the status.
 - AT: (connect testing)
 - OK: (auto answer)
 - AT+CPIN=0000 (Key in SIM card PIN code, ex 0000)
 - OK (auto answer, if any wrong, it will show "ERRIR")

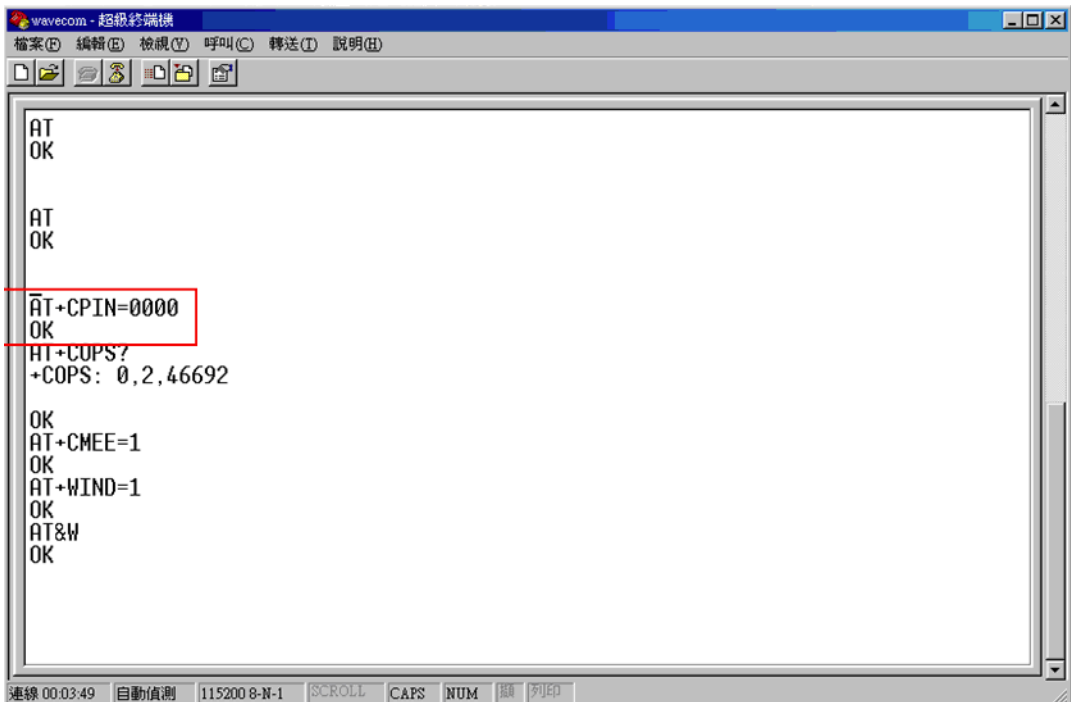

7. Execute the commands below to check signal and related connection information.
 - AT + COPS? (check the connecting condition with local telecom system)
 - +COPS: 0,2,46692 (if connect condition is okay, it shows 46692 automatically (46692 represents your local telecom system vendor))
 - OK (auto answer)
 - AT+CSQ : (check single strength)
 - +CSQ: 18,0 (higher value represents the stronger signal)
 - OK (auto answer)

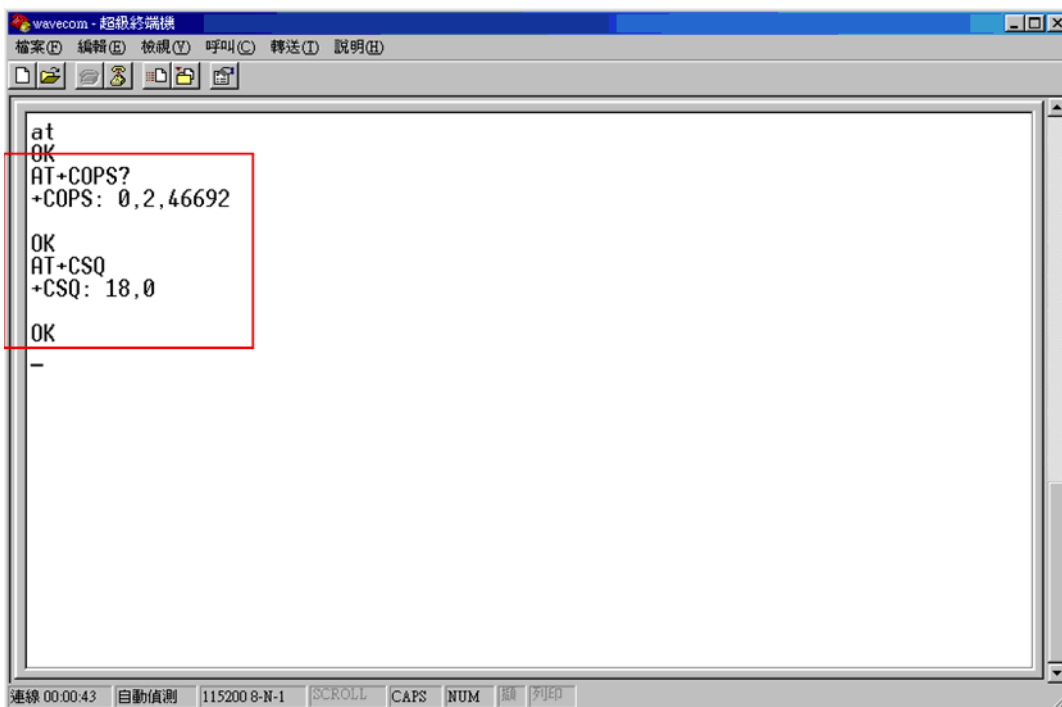

The screenshot shows a terminal window titled "wavecom - 超級終端機". The window contains the following text:

```
at
OK
AT+COPS?
+COPS: 0,2,46692

OK
AT+CSQ
+CSQ: 18,0

OK
-
```

A red box highlights the first two sets of command and response pairs. The status bar at the bottom of the window shows "連線 00:00:43", "自動偵測", "115200 8-N-1", "SCROLL", "CAPS", "NUM", "顯", and "列印".

8. To add a new internet connection.

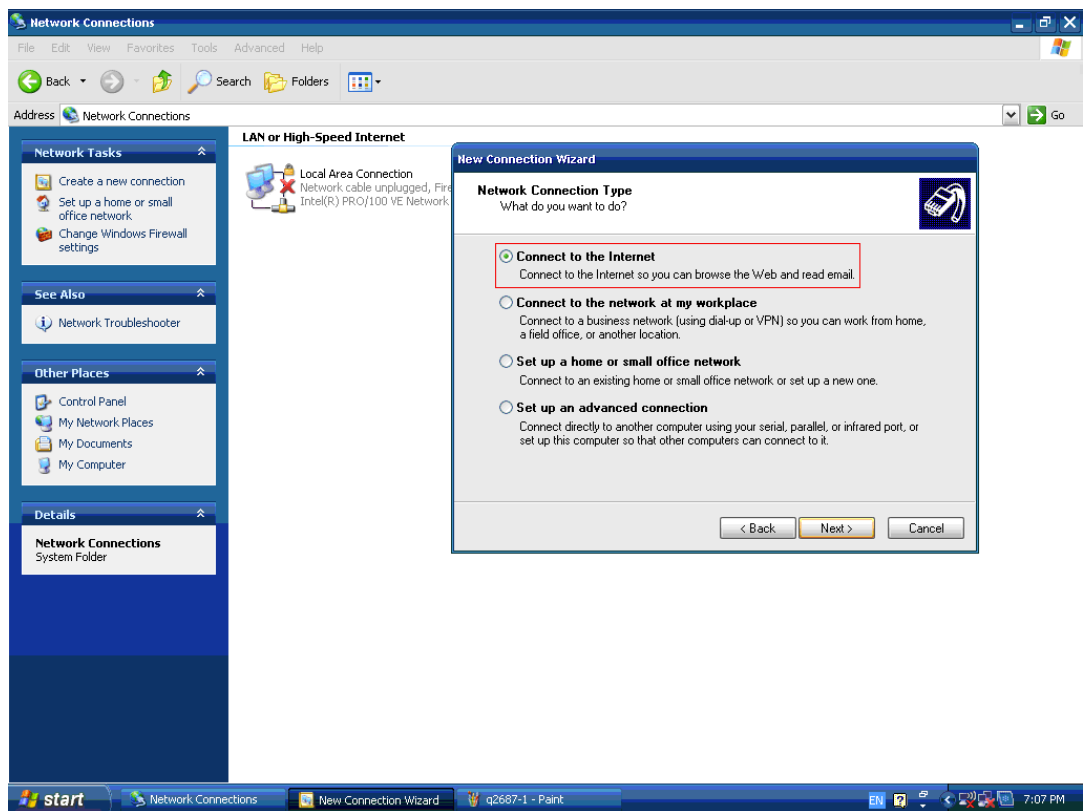
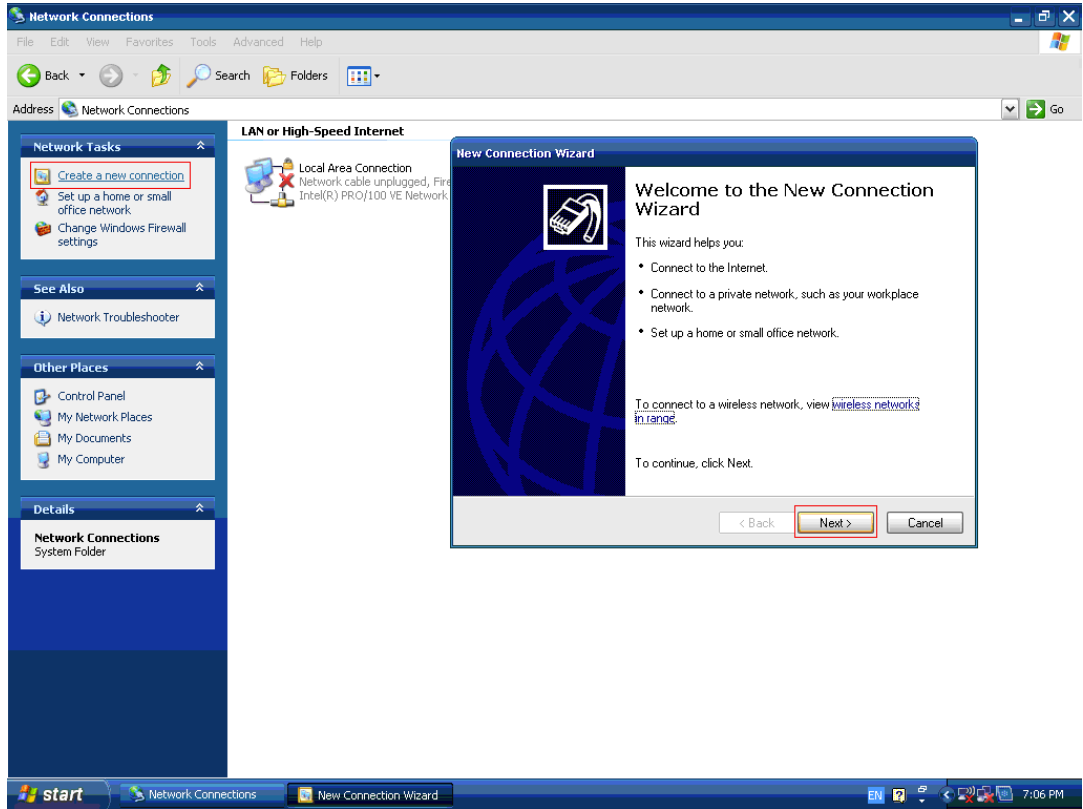

9. Select "Set up my connection manually"

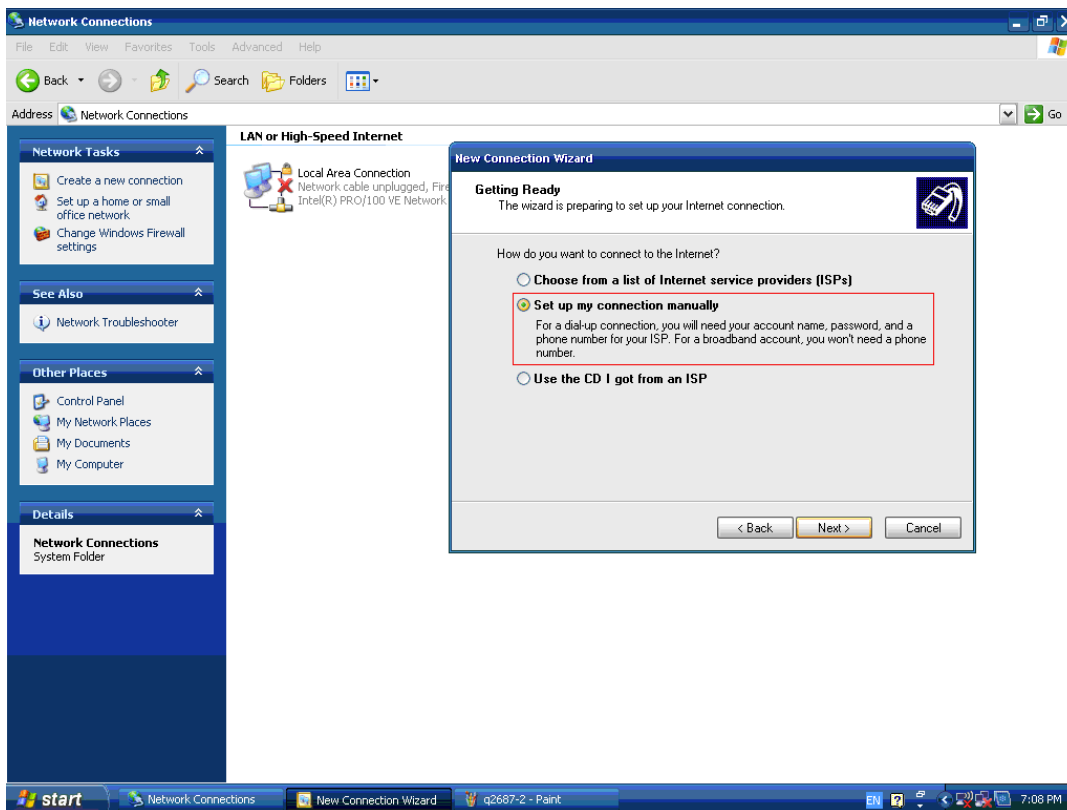

10. Select "Connect using a dial-up modem".

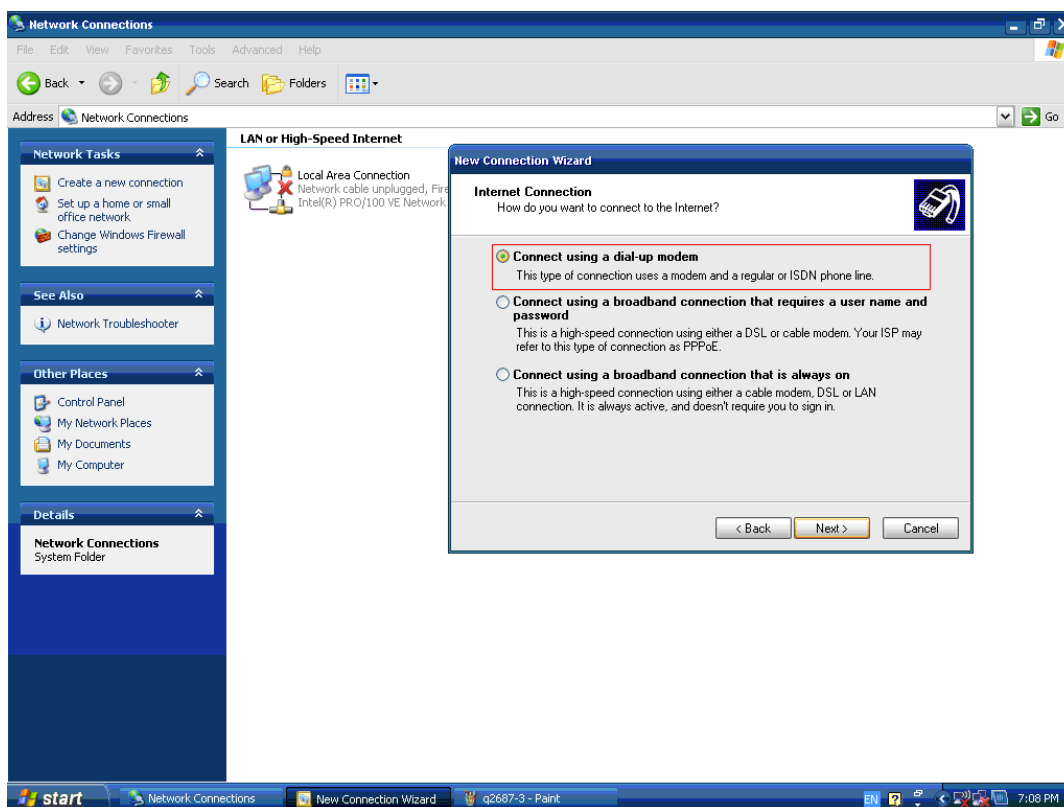

11. Set the connection name for recognition.

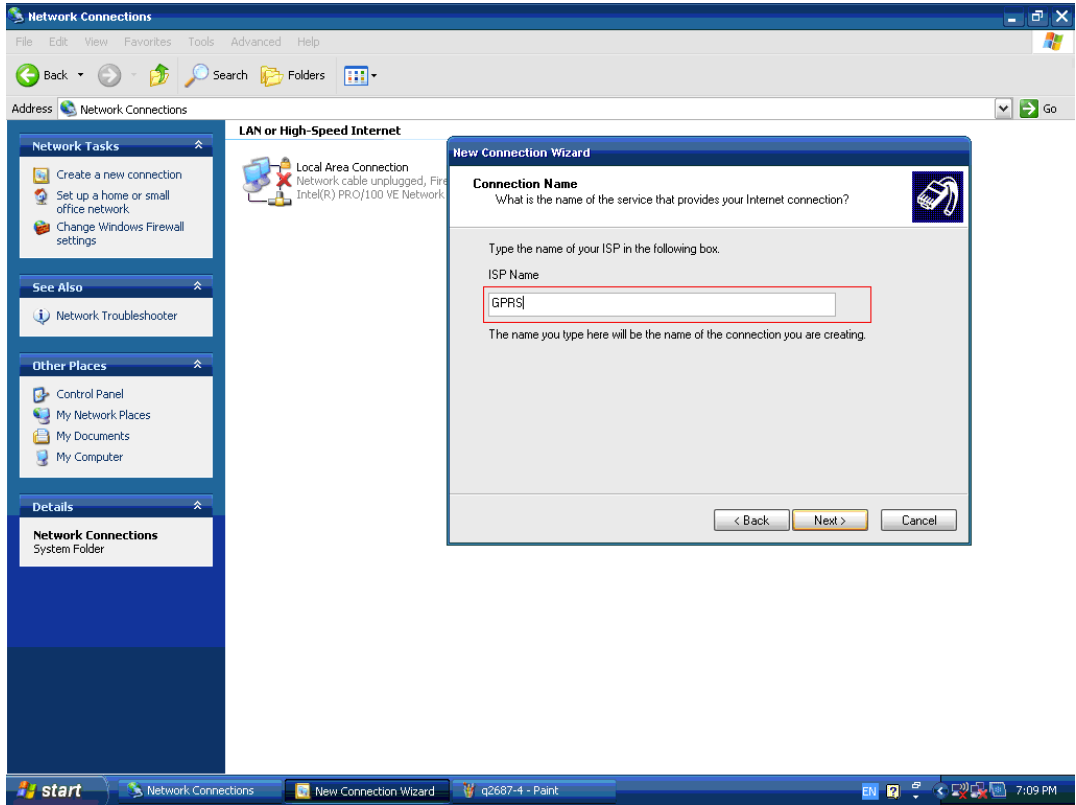

12. Dial your telecom system vendor number here

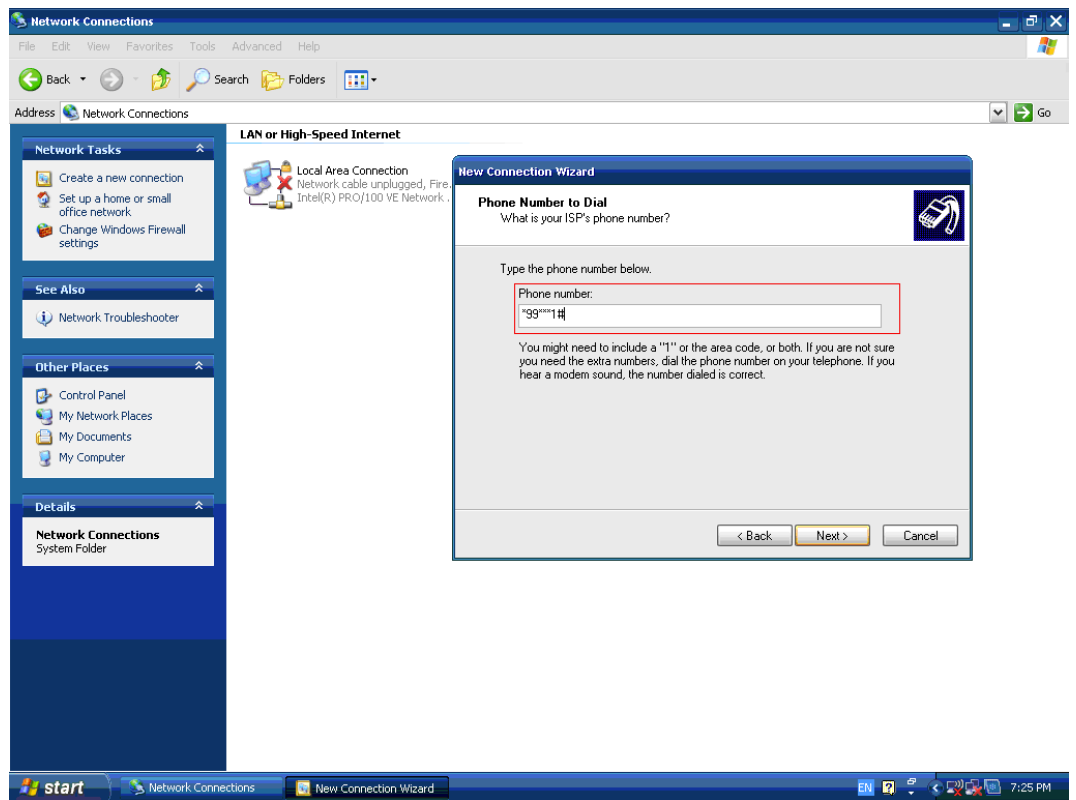

13. Click "Next" directly.

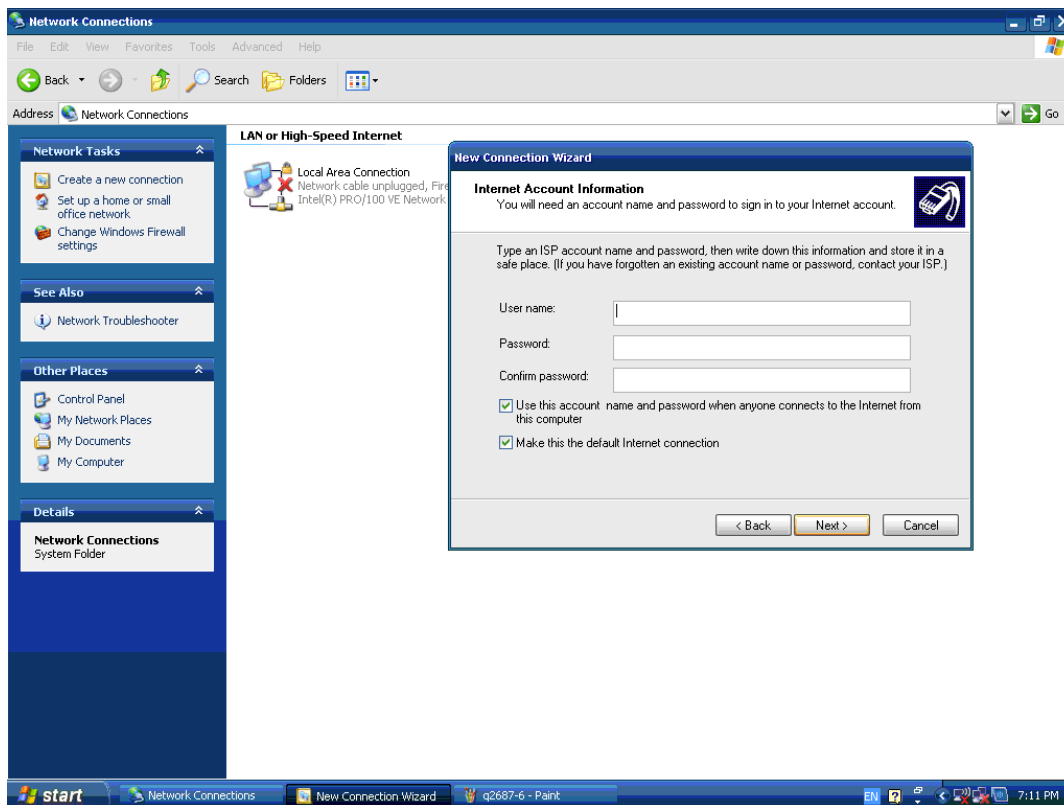

14. Click "Finish" to complete adding a new connection

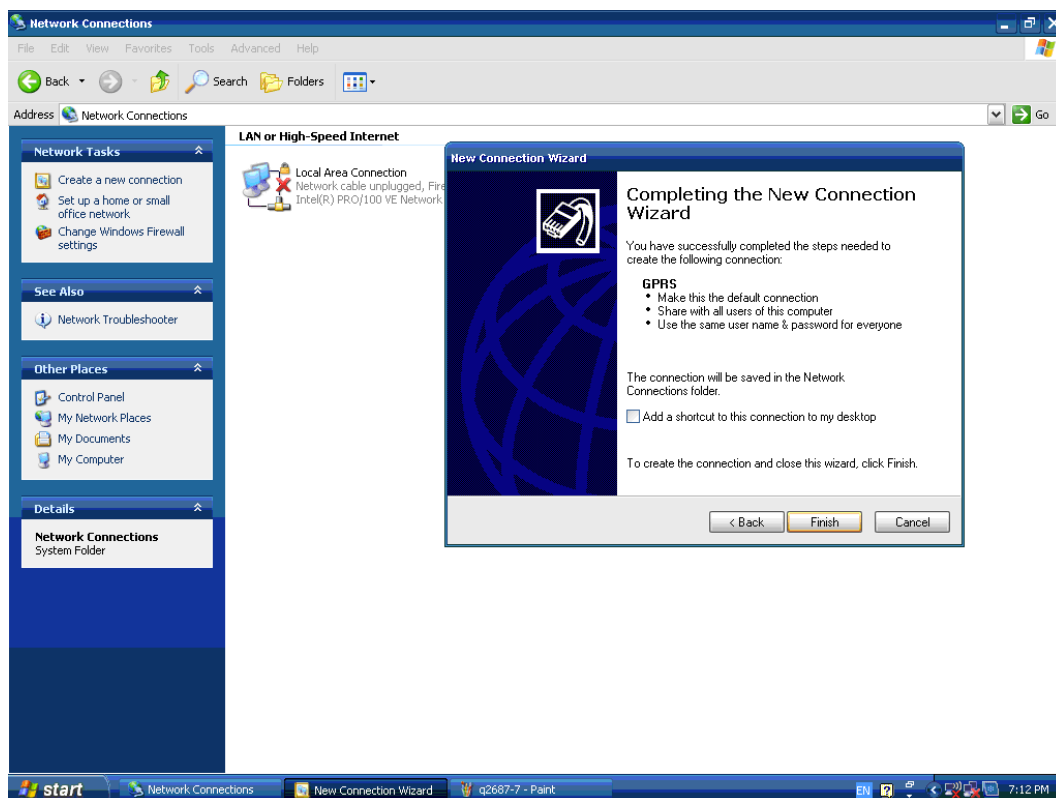

15. Double click the properties of the connection.

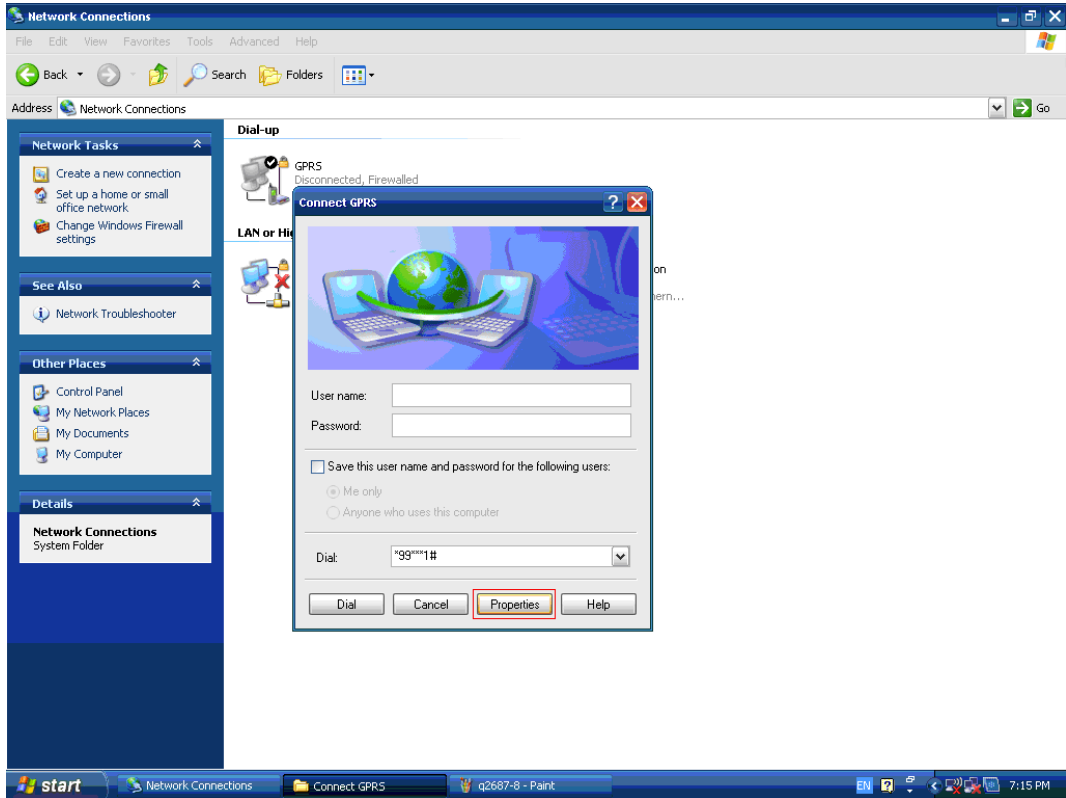

16. Set the maximum speed in the Modem Configuration.

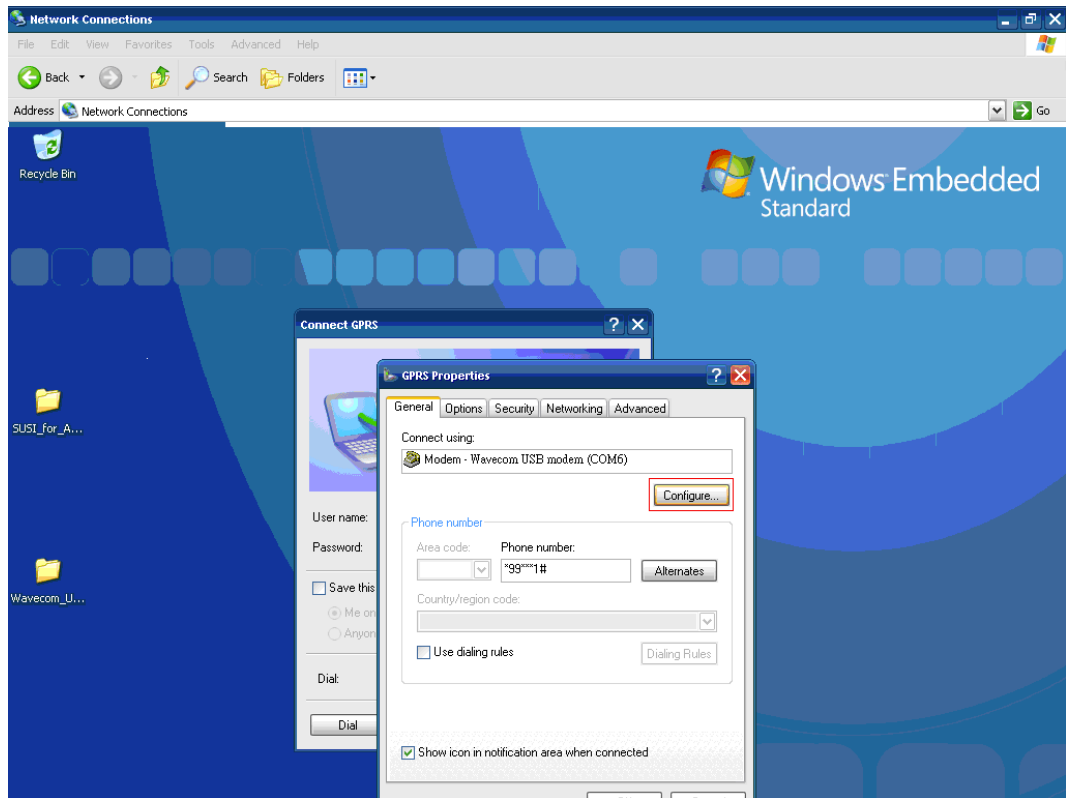

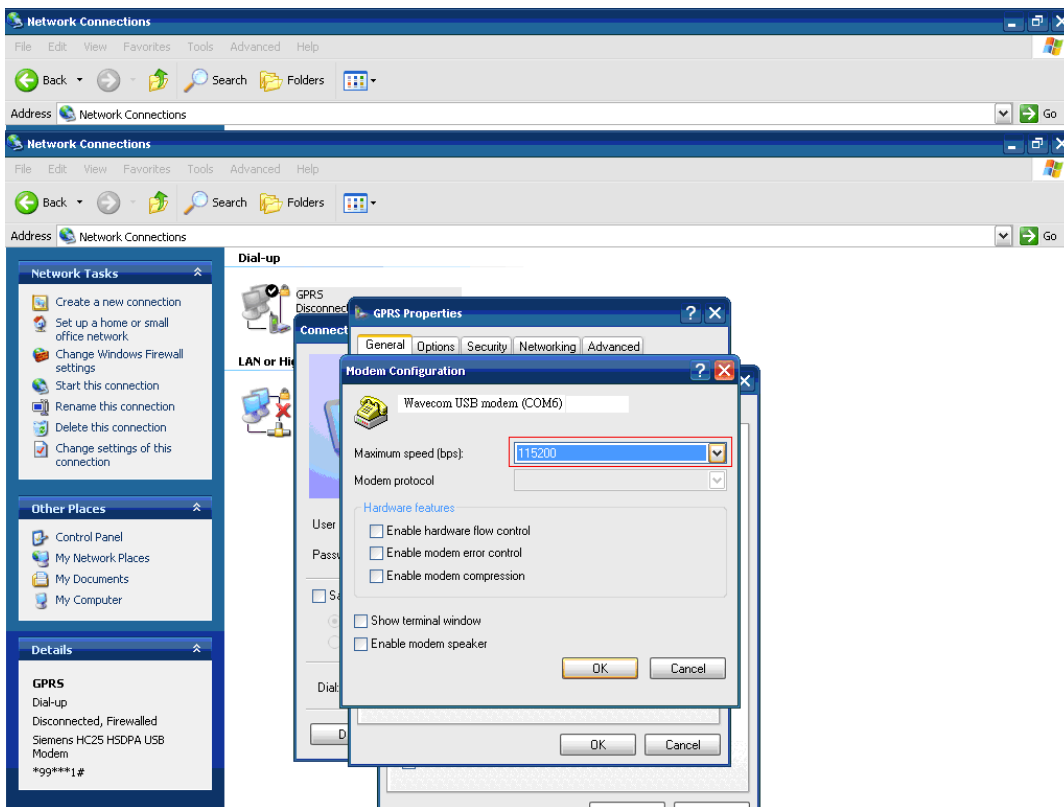

17. Double click the connection and then click "Dial" to connect to Internet.

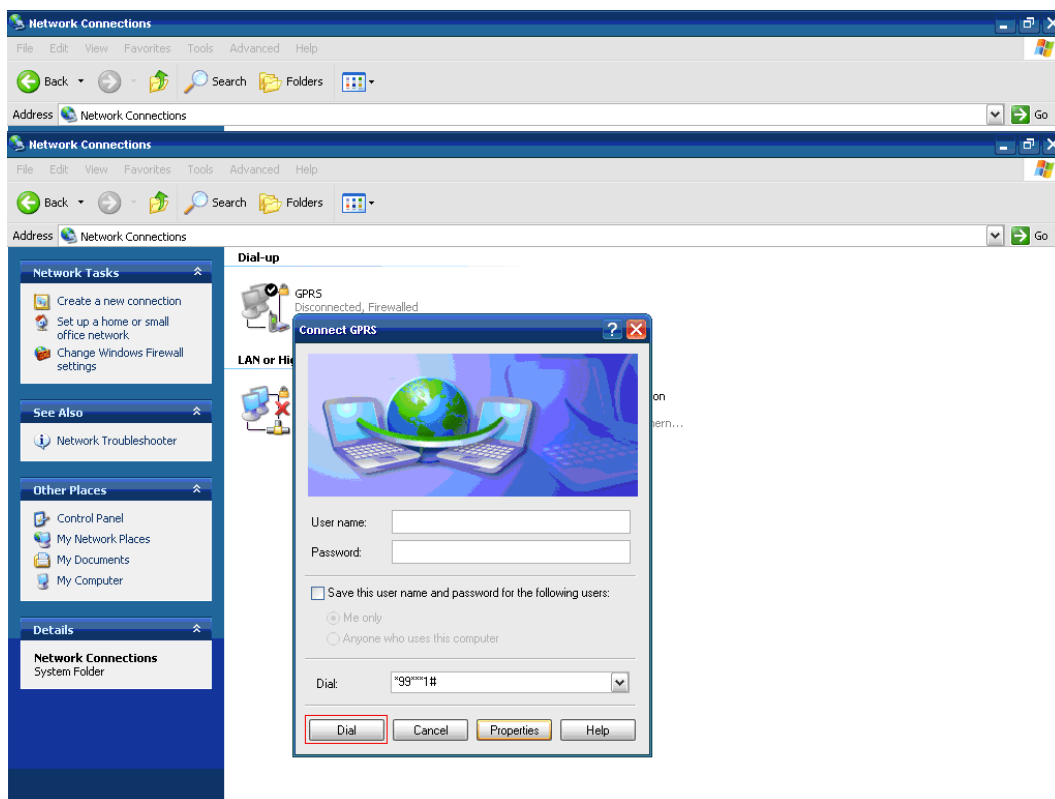

18. You can surf the internet now!

Appendix **C**

AMO-HSDPA GPRS
Module (HC25) Setting
Guide

C.1 AMO-HSDPA GPRS Module (HC25) Setting Guide

1. Boot up the ARK system, and enter the device manager; you will see three device items as shown below.

Siemens HC25 HSDPA USB Modem

Siemens HC25 Wireless Ethernet Adapter

Siemens HC25 USB COM Port (COM6)

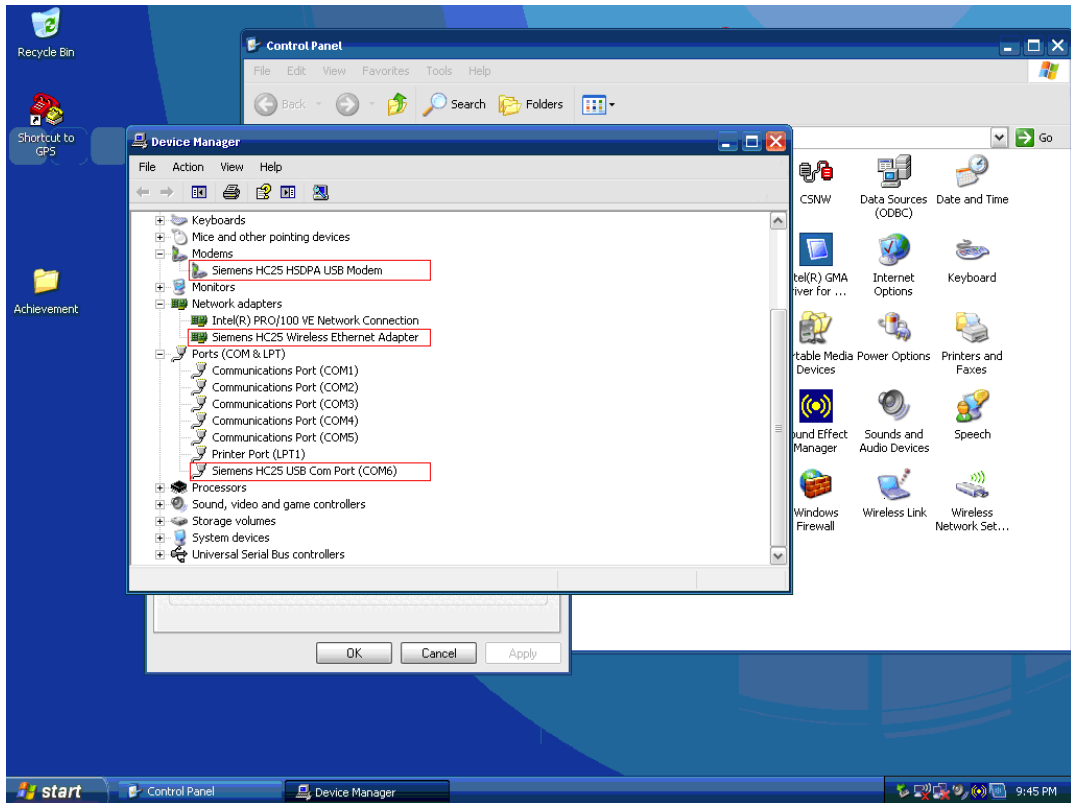

- Please follow the path below to add a new Hyper Terminal setting.

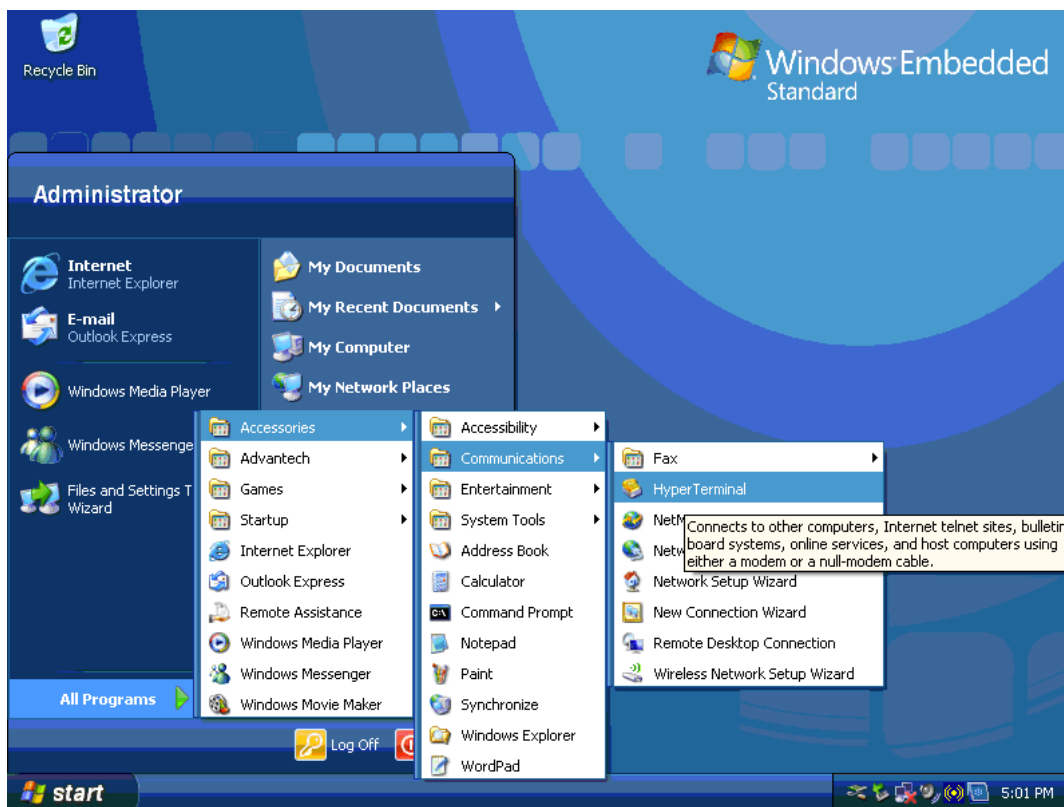

- Please select "Yes".

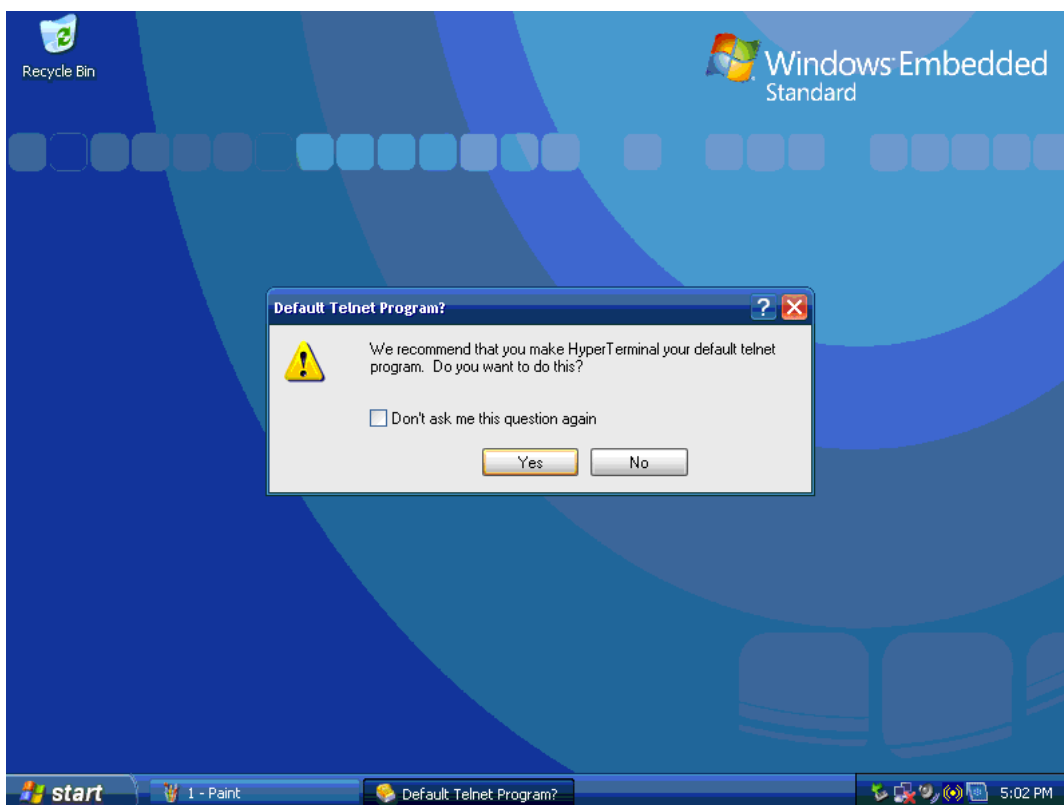

- Please select the country and key-in area code for your country as shown below, e.g., Taiwan is 886.

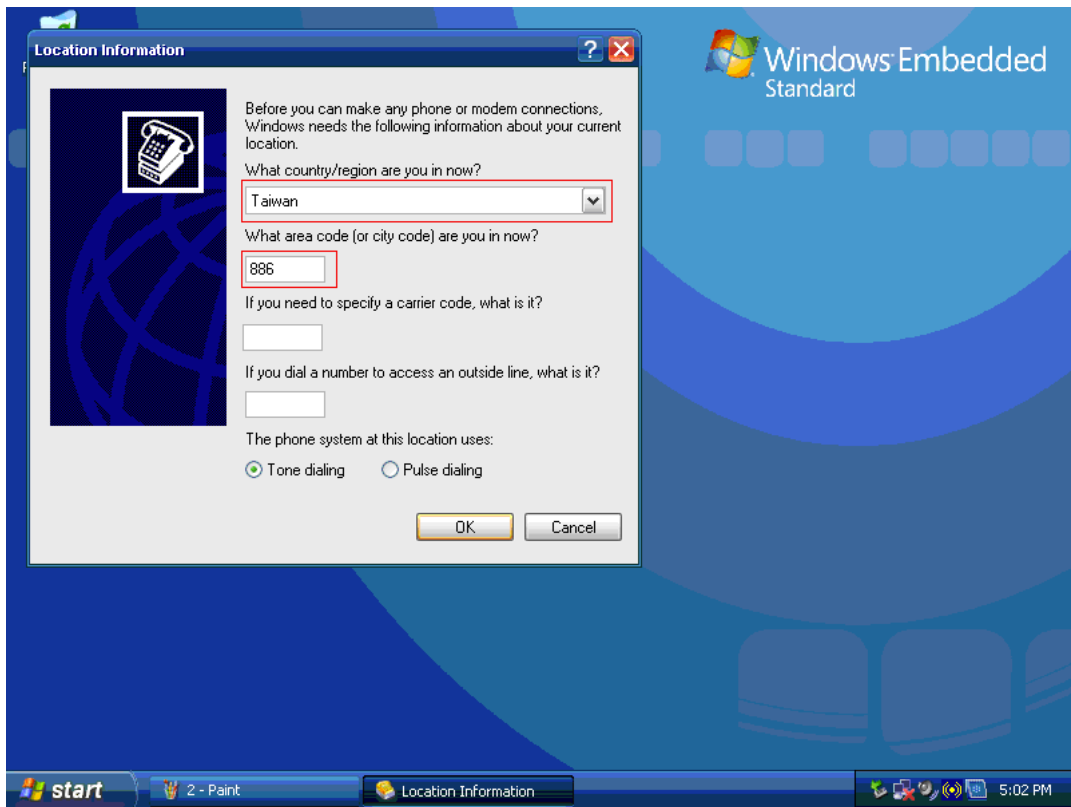

- Please select the "COM6", The GPRS Module on ARK-1388V works via COM6.
- Please set the item of "Bits per second" to "115200", and "Flow control" should be set to "None".

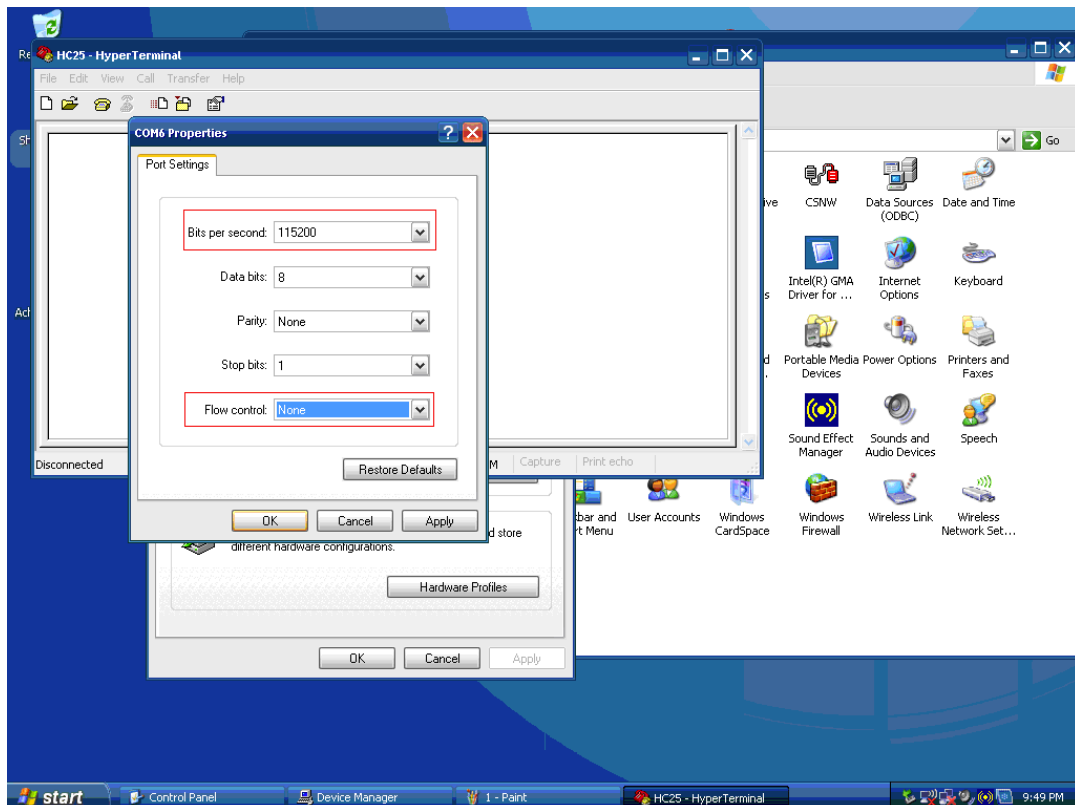

7. Follow the figures below to set the properties.

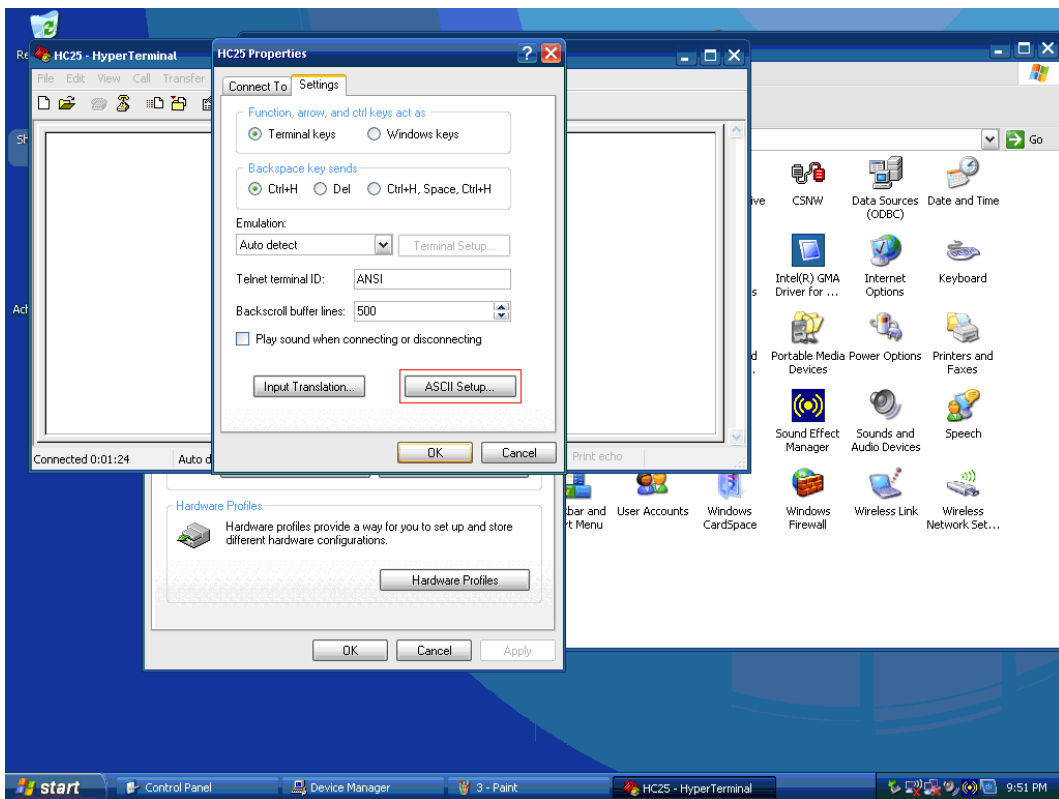
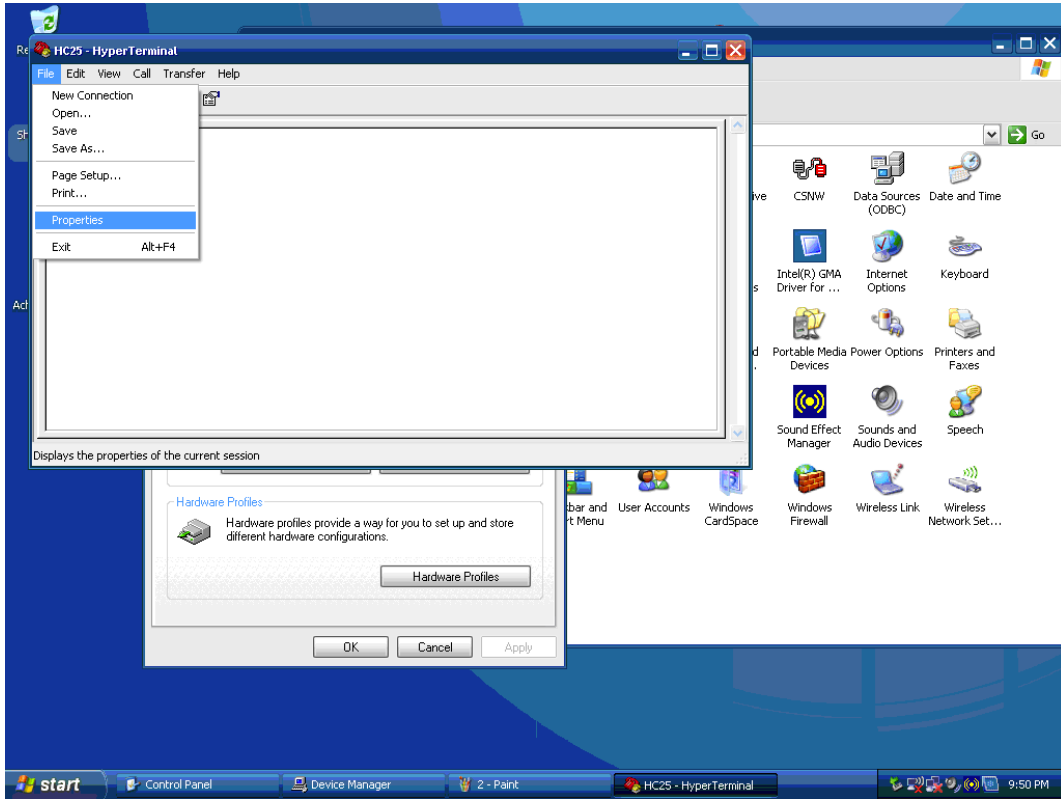

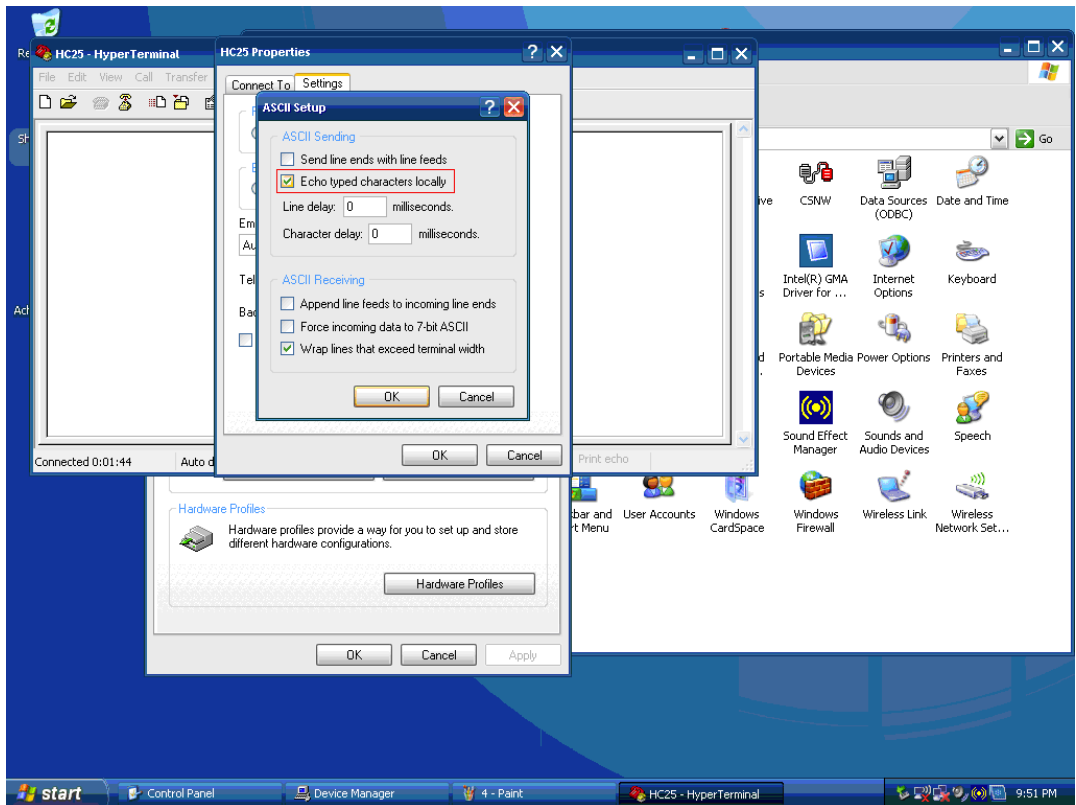

8. AMO-0101 GPRS module needs to enable the configuration upon first time use. The command is as below :
- AT^SUSB="MdmNet/TO","0"**

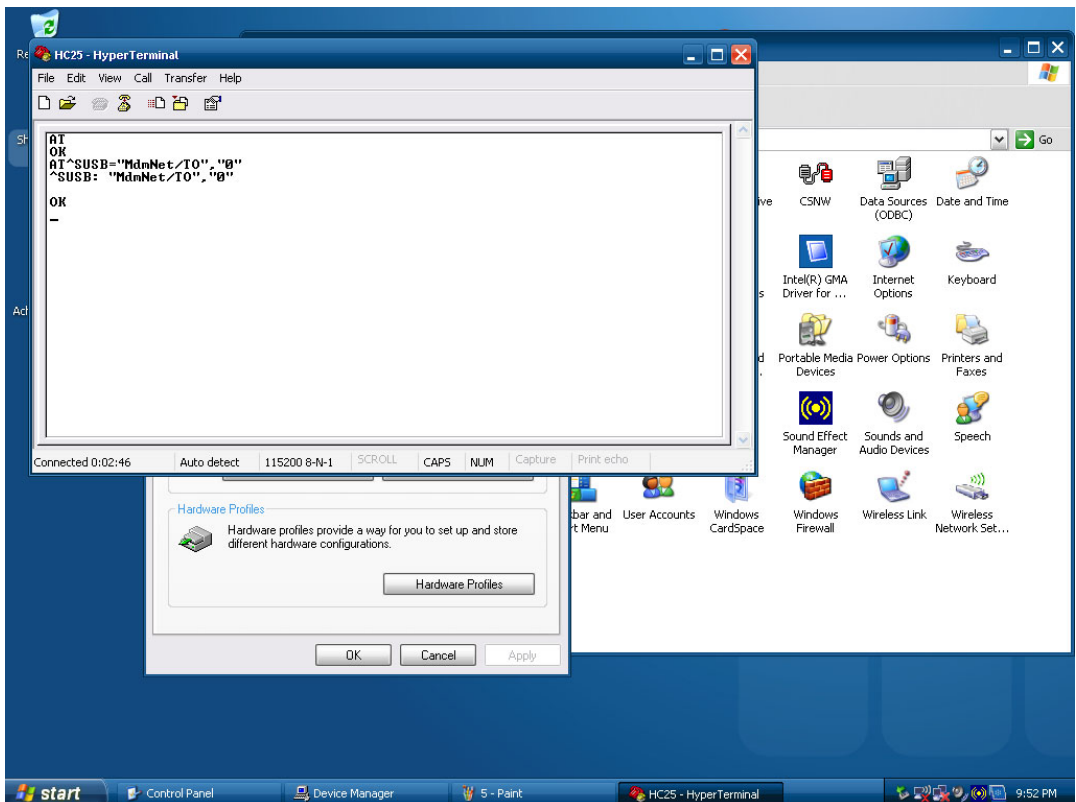

9. Next it needs to check if your SIM card has a PIN Code number or not. If yes, you need to login in your SIM.
10. Key-in the command show below to open the PIN Code on hyper terminal:
AT+CPIN=xxxx (where xxxx is the SIM card PIN Code)
 Example: If the PIN Code is 0000, please key-in the command as shown below.

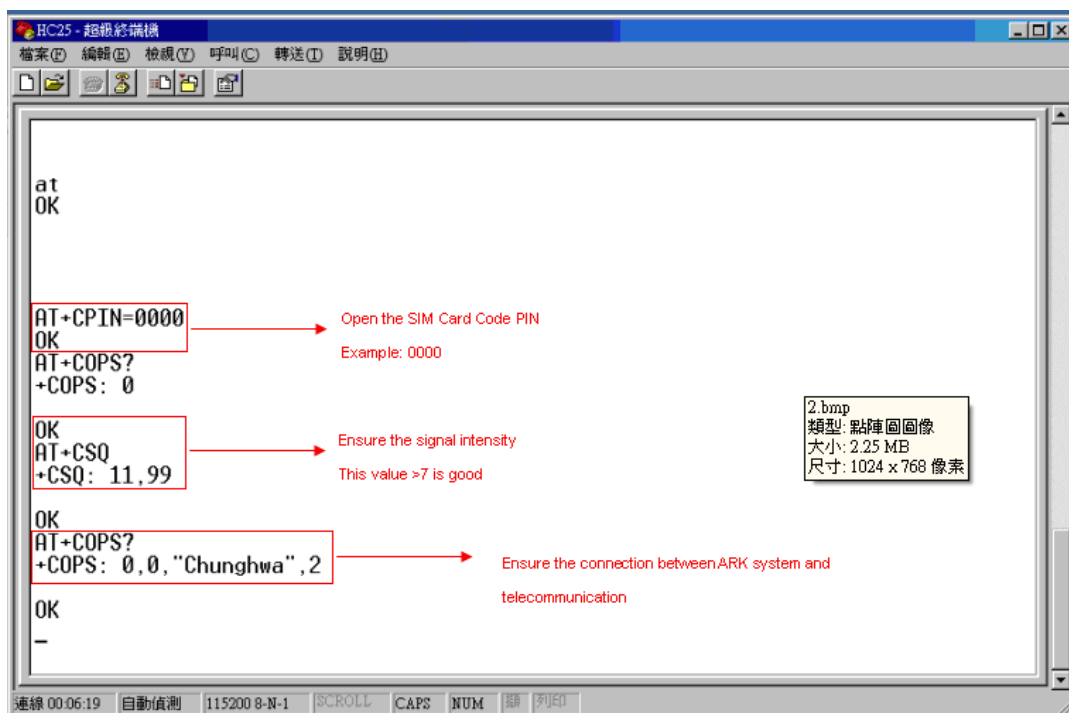

11. Normally it will respond "OK", and your SIM card PIN Code is working.

12. Execute the "Siemens Connection Manager", and follow the steps marked in red below:
APN name:internet
Authentication Preference:PAP

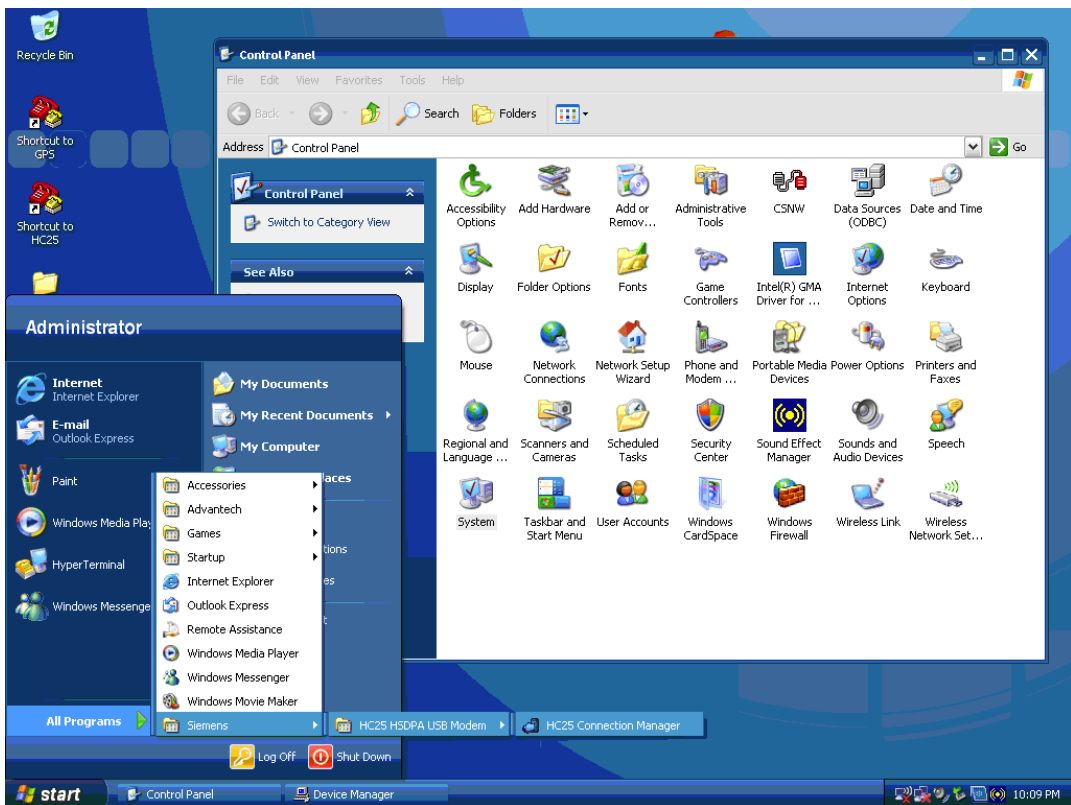

13. Press "Connect" to surf the internet through GPRS.

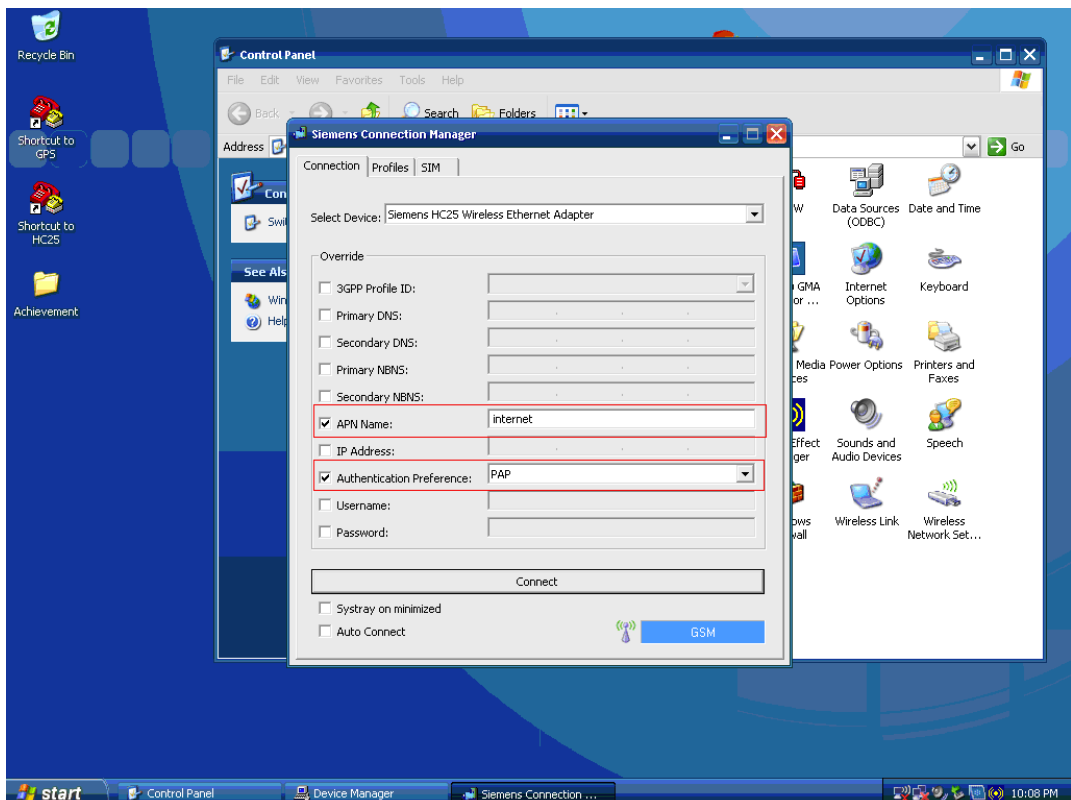

Trusted ePlatform Services

ADVANTECH

www.advantech.com

Please verify specifications before quoting. This guide is intended for reference purposes only.

All product specifications are subject to change without notice.

No part of this publication may be reproduced in any form or by any means, electronic, photocopying, recording or otherwise, without prior written permission of the publisher.

All brand and product names are trademarks or registered trademarks of their respective companies.

© Advantech Co., Ltd. 2009