

SEALED, ILLUMINATED ROCKER SWITCHES

K1/K2
SNAP-IN
ROCKERS

LOW COST, SNAP-IN ROCKER FOR WET & DUSTY ENVIRONMENTS

The K series rockers are rugged, high performance sealed switches designed for use under severe conditions found in marine, appliance, heavy equipment and industrial control applications. Sealed to IP68S with an optional panel gasket available.

The K1 series is offered in single pole configuration while the K2 series is available in single and double pole configurations. Both series offer illuminated models. Illumination can be independent or dependent of the switch position or a combination of both. A choice of red, green, clear or amber colored lenses are offered in illuminated models. Illumination options include incandescent, LED or neon light sources.

Mounting is simple and quick; snaps into panel from the front. The OTTO snap-in design supports a variety of panel thicknesses with just one cutout size specified.

A choice of models are offered to handle power levels to 16 amps, 1/2 HP and low level electronic switching applications.

OTTO can provide custom colors upon request. Value-added assemblies with wire leads are also available. Please consult the factory for assistance.



K1 Series
Single Pole



K2 Series
Single & Double Pole



Features:

- Withstands direct water spray
- Watertight to IP68S
- Fits industry standard panel openings for drop-in replacement of panel sealed & unsealed switches
- Snap-in feature accommodates a wide range of panel cutouts
- Switches up to 16 amps
- UV & solvent resistant
- Withstands extreme shock & vibration
- Custom legends available
- 2 & 3-position, momentary & maintained action
- Incandescent, LED & neon illumination with independent & dependent light source options
- UL recognized & CSA certified
- Ignition protected
- RoHS/WEEE/Reach compliant

Standard Characteristics/Ratings:

ELECTRICAL RATINGS:

Load	Sea Level @ 28VDC or 125/250VAC, 60Hz	Cycles
Resistive	16A	25,000
Resistive	10A	50,000
Inductive	10A	25,000
Lamp	5A	25,000
Motor	0.5HP	25,000
DWV	1050Vrms except across light terminals	
Low Level	10mA @ 30mV	

Electrical Life: See Rating Chart

LIGHTING:

Light Source	Rating
Incandescent	(VDC) 6V, 12V, 24V
Neon	(VAC) 125V, 250V
LED	(VDC) 2V, 6V, 12V, 24V

Mechanical Life: 100,000 cycles

Seal: IP68S

Operating Temp Range: -30°C to +85°C

MATERIALS:

Case:	Thermoplastic
Button:	Thermoplastic
Base:	Thermoplastic
Terminals/Contact:	Brass, silver alloy with silver plate, gold flash for low level
Terminal Hardware:	Screws and lockwashers provided when applicable K1/K2 series recommended Quick Connect terminals: AMP 60253-2 for 12-16 AWG AMP 42100-2 for 14-18 AWG
Mounting Hardware:	None provided

SEALED, ILLUMINATED ROCKER SWITCHES

LOW COST, SNAP-IN ROCKER FOR WET & DUSTY ENVIRONMENTS

K1 PART NUMBER CODE

K1 - **X** **X** **X** **X** **X** **Part Number Code Continued Below**

<p>Terminal Style/ Switch Rating</p> <p>A. Q.C./Std. B. Screw/Std. C. Solder/Std. D. Q.C./Low Level E. Screw/Low Level F. Solder/Low Level G. PC Pin/Std. H. PC Pin/Low Level</p>	<p>Actuator Color/Style</p> <p>A. Red/Rocker B. Black/Rocker C. White/Rocker D. Red/Paddle E. Black/Paddle F. White/Paddle G. Red/Rocker Pinned H. Black/Rocker Pinned J. White/Rocker Pinned K. Red/Short Paddle Pinned L. Black/Short Paddle Pinned M. White/Short Paddle Pinned N. Red/Standard Paddle Pinned P. Black/Standard Paddle Pinned R. White/Standard Paddle Pinned T. Red/Short Paddle U. Black/Short Paddle V. White/Short Paddle</p>	<p>Switch Action/Circuit</p> <table border="1"> <thead> <tr> <th></th> <th>Position "A"</th> <th>Position "B"</th> <th>Position "C"</th> <th>Circuit</th> </tr> </thead> <tbody> <tr> <td>A.</td> <td>1-C</td> <td>NONE</td> <td>OFF</td> <td>SPST</td> </tr> <tr> <td>B.</td> <td>1-C</td> <td>NONE</td> <td>2-C</td> <td>SPDT</td> </tr> <tr> <td>C.</td> <td>(1-C)</td> <td>NONE</td> <td>OFF</td> <td>SPST</td> </tr> <tr> <td>D.</td> <td>(1-C)</td> <td>NONE</td> <td>2-C</td> <td>SPDT</td> </tr> <tr> <td>E.</td> <td>(1-C)</td> <td>OFF</td> <td>(2-C)</td> <td>SPDT</td> </tr> <tr> <td>F.</td> <td>1-C</td> <td>OFF</td> <td>2-C</td> <td>SPDT</td> </tr> <tr> <td>G.</td> <td>(1-C)</td> <td>OFF</td> <td>2-C</td> <td>SPDT</td> </tr> <tr> <td>H.</td> <td>OFF</td> <td>NONE</td> <td>2-C</td> <td>SPST</td> </tr> </tbody> </table> <p>NOTE: () denotes momentary action.</p>		Position "A"	Position "B"	Position "C"	Circuit	A.	1-C	NONE	OFF	SPST	B.	1-C	NONE	2-C	SPDT	C.	(1-C)	NONE	OFF	SPST	D.	(1-C)	NONE	2-C	SPDT	E.	(1-C)	OFF	(2-C)	SPDT	F.	1-C	OFF	2-C	SPDT	G.	(1-C)	OFF	2-C	SPDT	H.	OFF	NONE	2-C	SPST	<p>Light Type</p> <p>A. No Light B. 6V Incandescent C. 12V Incandescent D. 24V Incandescent E. 125VAC Neon F. 250VAC Neon G. 2V Red LED H. 2V Green LED J. 2V Amber LED K. 6V Red LED L. 6V Green LED M. 6V Amber LED N. 12V Red LED P. 12V Green LED Q. 12V Amber LED R. 24V Red LED S. 24V Green LED T. 24V Amber LED</p>
	Position "A"	Position "B"	Position "C"	Circuit																																												
A.	1-C	NONE	OFF	SPST																																												
B.	1-C	NONE	2-C	SPDT																																												
C.	(1-C)	NONE	OFF	SPST																																												
D.	(1-C)	NONE	2-C	SPDT																																												
E.	(1-C)	OFF	(2-C)	SPDT																																												
F.	1-C	OFF	2-C	SPDT																																												
G.	(1-C)	OFF	2-C	SPDT																																												
H.	OFF	NONE	2-C	SPST																																												

Position "A"

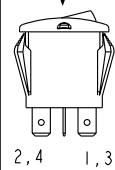

2, 4 1, 3

Position "B"

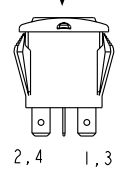

2, 4 1, 3



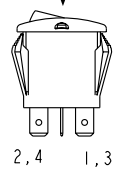







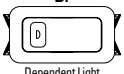

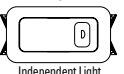
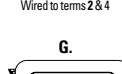
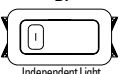

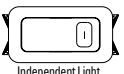

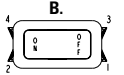

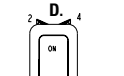

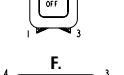
Position "C"

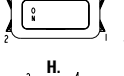

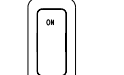
2, 4 1, 3

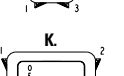
K1 PART NUMBER CODE CONTINUED FROM ABOVE

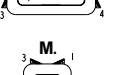
K1 Continued **X** **X** **X** **X** **X**

<p>Lens Color</p> <table border="0"> <tr> <th>Position "A"</th> <th>Position "C"</th> </tr> <tr> <td>A. No Lens</td> <td>A. No Lens</td> </tr> <tr> <td>B. Red</td> <td>B. Red</td> </tr> <tr> <td>C. Green</td> <td>C. Green</td> </tr> <tr> <td>D. Amber</td> <td>D. Amber</td> </tr> <tr> <td>E. Clear</td> <td>E. Clear</td> </tr> </table>	Position "A"	Position "C"	A. No Lens	A. No Lens	B. Red	B. Red	C. Green	C. Green	D. Amber	D. Amber	E. Clear	E. Clear	<p>Light/Circuit Location</p> <p>A. No Light</p> <div style="display: flex; flex-wrap: wrap;"> <div style="width: 50%;"> <p>B.</p>  <p>Dependent Light ON in position "A" Wired to terms 1 & 3</p> </div> <div style="width: 50%;"> <p>F.</p>  <p>Dependent Light ON in position "A" Wired to terms 1 & 3</p> </div> <div style="width: 50%;"> <p>C.</p>  <p>Independent Light ON in position "C" Wired to terms 2 & 4</p> </div> <div style="width: 50%;"> <p>G.</p>  <p>Dependent Light ON in position "A" Wired to terms 1 & 3</p> </div> <div style="width: 50%;"> <p>D.</p>  <p>Independent Light at position "A" Wired to terms 3 & 4</p> </div> <div style="width: 50%;"> <p>H.</p>  <p>Independent Light at position "A" Wired to terms 3 & 4</p> </div> <div style="width: 50%;"> <p>E.</p>  <p>Independent Light at position "C" Wired to terms 3 & 4</p> </div> <div style="width: 50%;"> <p>I.</p>  <p>Independent Light ON in position "C" Wired to terms 2 & 4</p> </div> </div> <p>D = Dependent Light I = Independent Light</p> <p>NOTES:</p> <ul style="list-style-type: none"> LED anode (+) terminal number shown in bold. Light on OFF side must be independent. Contact factory for multiple light types in the same switch. 	<p>Legend & Orientation</p> <p>A. None</p> <div style="display: flex; flex-wrap: wrap;"> <div style="width: 50%;"> <p>B.</p>  </div> <div style="width: 50%;"> <p>C.</p>  </div> <div style="width: 50%;"> <p>D.</p>  </div> <div style="width: 50%;"> <p>E.</p>  </div> <div style="width: 50%;"> <p>F.</p>  </div> <div style="width: 50%;"> <p>G.</p>  </div> <div style="width: 50%;"> <p>H.</p>  </div> <div style="width: 50%;"> <p>J.</p>  </div> <div style="width: 50%;"> <p>K.</p>  </div> <div style="width: 50%;"> <p>L.</p>  </div> <div style="width: 50%;"> <p>M.</p>  </div> <div style="width: 50%;"> <p>N.</p>  </div> <div style="width: 50%;"> <p>P.</p>  </div> <div style="width: 50%;"> <p>R.</p>  </div> </div>
Position "A"	Position "C"													
A. No Lens	A. No Lens													
B. Red	B. Red													
C. Green	C. Green													
D. Amber	D. Amber													
E. Clear	E. Clear													

NOTES:

- No momentary switches with dependent lights.
- Neon lamps only to be coded with clear or amber lenses.
- LED lenses must be clear or same color as LED.
- No dependent light in OFF position.
- All legends printed on actuators without lens(es) will be white except actuator codes C, F, J, M & R.
- All legends printed on lenses will be white except on clear lens(es) will be black.

• K1 panel plugs available as shown on page 160.

SEALED, ILLUMINATED ROCKER SWITCHES

LOW COST, SNAP-IN ROCKER FOR WET & DUSTY ENVIRONMENTS

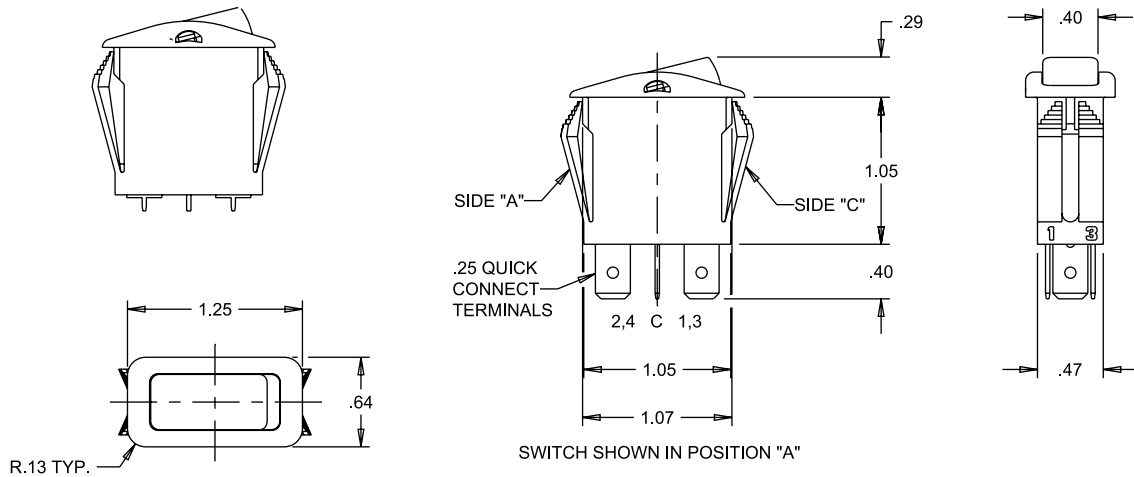

MOUNTING HOLE:
 PANEL THICKNESS RANGE OF .025 - .105 A GASKET IS RECOMMENDED,
 0.031" THICKNESS = GASKET P/N 807039-2
 0.062" THICKNESS = GASKET P/N 807039-1

PANEL THICKNESS RANGE OF .105 - .187 W/O GASKET
 PANEL OPENING: MIN. TYP. MAX.
 WIDTH .480 .515 .550
 LENGTH 1.072 1.099 1.125

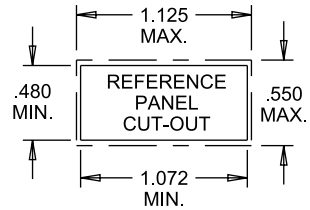

P.C. PIN LAYOUT			
PADDLE STYLES			
SHORT PADDLE ROCKER	STANDARD PADDLE ROCKER		
TERMINAL STYLES (.032 THICK)			
SCREW	QUICK CONNECT	SOLDER	P.C. PIN

ROCKER SWITCHES

SNAP-IN PANEL MOUNTING

Standard Legends Per SAE Specifications

STANDARD LEGENDS PER SAE SPECIFICATIONS								
A1		ANCHOR	K2		UNLOCK	P5		BILGE BLOWER
B1		BATTERY	L1		LIGHT	R1		LIFT
B2		ELECTRIC POWER	L2		MASTER LIGHTING SWITCH	R2		LOWER
C1		AC/COOLING SYSTEMS	L3		HEADLIGHTS	R3		UP
C2		DEHUMIDIFIER	L4		HEADLIGHTS-LOW / DIPPED BEAM	R4		DOWN
C3		HEATER/INTERIOR HEATING	L5		HEADLIGHTS-HIGH / UPPER BEAM	R5		RIGHT
D1		WINDSHIELD DEFROSTER	L6		PARKING LIGHT	R6		LEFT
D2		REAR WINDOW DEFROSTER	L7		WORK LAMP	R7	FWD	FORWARD
D3		MIRROR DEFROSTER	L8		WORK LAMP	R8	REV	REVERSE
E1		ENGINE/START	L9		INTERIOR DOME LIGHT	S1		RADIO
E2		ENGINE/STOP	M1		BEACON	S2		MUTE
E3		ON/START	M2		HAZARD/POSITION LIGHTS	T1		FAST
E4	○	OFF/STOP	M3		CLEARANCE LIGHTS	T2		SLOW
E5	ON	ON	M4		SIDE MARKER LIGHT	T3		TRIM TAB / TRIMMING OPERATION
E6	OFF	OFF	M5		RUNNING LIGHTS (UNDER POWER)	T4		TRANSMISSION
E7		ENGINE ELECTRIC PREHEAT	M6		ANCHOR LIGHT	V1		VENTILATING / AC FAN
E8		ENGINE-GAS INJECTION	M7		RUNNING/ANCHOR LIGHTS	W1		WINDSHIELD WIPER
F1		FRONT FOG LIGHTS	M8		SEARCH LIGHT	W2		WINDSHIELD-WASHER
F2		REAR FOG LIGHTS	M9		LEFT TURN SIGNAL	W3		WINDSHIELD-WASHER/WIPER
G1		FUEL	MA		RIGHT TURN SIGNAL	W4		REAR WINDOW WIPER
H1		HORN	P1		BILGE PUMP #1	W5		REAR WINDOW-WASHER
H2		HORN REAR	P2		BILGE PUMP #2	W6		REAR WINDOW-WASHER/WIPER
K1		LOCK	P3		BILGE PUMP #3	ZZ		NO LEGEND
			P4		BILGE PUMP			

For legends not shown, please consult an OTTO representative.