

POLYSWITCH RESETTABLE DEVICES

Automotive Devices

We have provided PPTC resettable devices for the automotive industry for over 25 years. With the advent of TS16949 and our continued involvement in the automotive industry, Littelfuse PolySwitch team developed automotive-specific versions of PPTC devices (femtoASMD, picoASMD, nanoASMD, microASMD, miniASMD, ASMD, nanoASMDCH, AHS, ASMD, AHRF, AHEF and AGRF). These products are qualified and sold under the PS400 specification which is derived from AEC-Q200, the standard for electronic components used in the automotive industry. The key difference between these product families and other protection devices in our circuit protection product portfolio is the qualification process that is followed that includes a series of rigorous tests related to the automotive environment. As a result, they are characterized by specific additional values determined following automotive-related testing.



BENEFITS

- Expertise from the world's leading resettable overcurrent protection manufacturer
- High-quality products from the world's largest passive component manufacturer
- Worldwide team dedicated to support automotive applications
- Wide range of dedicated automotive surface-mount and radial-leaded resettable overcurrent devices
- High-performance transient voltage protection devices

FEATURES

- RoHS compliant
- Overcurrent and overvoltage circuit protection devices
- Resettable and single-use overcurrent devices
- Wide range of form factor and termination methods
- Products meet applicable automotive industry standards
- Devices compatible with high-volume electronics assembly

APPLICATIONS

- Motor and motor circuit protection including power door-locks, mirrors, lumbar pumps, seats, sunroofs and windows
- Electronic Control Unit (ECU) I/O protection
- Heating, Ventilation and Cooling (HVAC) motor and I/O protection
- Telematics, infotainment and navigations systems
- Liquid Crystal Display (LCD) back-light heaters
- Power and cigarette lighter outlets, plugs and adapter/chargers
- Powered networks and buses
- Air-flow detection and overcurrent protection in HVAC and cooling fan systems
- Stall detection in express window and sunroof circuits
- Resettable overcurrent protection for power distribution, electrical centers and junction boxes
- Wire downsizing
- Motor electromagnetic interference (EMI) suppression
- Electrostatic discharge (ESD) damage protection
- Load dump and other transient voltage protection

PolySwitch Resettable Devices

Automotive Devices

Table A1 — Product Series - Current Rating, Voltage Rating/Typical Resistance

Voltage Rating	AGRF 16V	AHRF 16V	AHRF 30V	AHEF 32V	AHS 16V	ASMD 16V	ASMD 30V	ASMD 33V	ASMD 60V
Hold Current (A)									
0.30	—	—	—	—	—	—	—	—	2.90Ω
0.50	—	—	0.565Ω	0.5650Ω	—	—	—	—	0.90Ω
0.70	—	—	0.385Ω	0.3850Ω	—	—	—	—	—
0.75	—	—	—	—	—	—	0.60Ω	—	—
0.80	—	—	—	—	0.250Ω	—	—	—	—
1.00	—	—	0.225Ω	0.2250Ω	—	—	0.30Ω	—	—
1.20	—	—	—	—	0.245Ω	—	—	—	—
1.25	—	—	—	—	—	0.160Ω	—	—	—
1.50	—	—	—	—	—	0.140Ω	—	0.149Ω	—
1.60	—	—	—	—	0.100Ω	—	—	—	—
1.85	—	—	—	—	—	0.079Ω	—	—	—
2.00	—	0.0565Ω	—	—	0.070Ω	0.090Ω	—	—	—
2.50	—	—	—	—	—	0.060Ω	—	—	—
3.00	—	0.0410Ω	—	0.0520Ω	0.050Ω	—	—	—	—
4.00	0.0300Ω	0.0305Ω	—	—	—	—	—	—	—
4.50	—	0.0290Ω	—	—	—	—	—	—	—
5.00	0.0192Ω	—	—	0.0200Ω	—	—	—	—	—
5.50	—	0.0190Ω	—	—	—	—	—	—	—
6.00	0.0145Ω	0.0180Ω	—	—	—	—	—	—	—
6.50	—	0.0140Ω	—	—	—	—	—	—	—
7.00	0.0105Ω	0.0126Ω	—	—	—	—	—	—	—
7.50	—	0.0120Ω	—	0.0120Ω	—	—	—	—	—
8.00	0.0086Ω	0.0104Ω	—	—	—	—	—	—	—
9.00	0.0070Ω	0.0100Ω	—	—	—	—	—	—	—
10.00	0.0056Ω	0.0083Ω	—	0.0083Ω	—	—	—	—	—
11.00	0.0050Ω	0.0069Ω	—	—	—	—	—	—	—
12.00	0.0046Ω	—	—	—	—	—	—	—	—
13.00	—	0.0055Ω	—	—	—	—	—	—	—
14.00	0.0040Ω	0.0050Ω	—	—	—	—	—	—	—
15.00	—	0.0050Ω	—	—	—	—	—	—	—

PolySwitch Resettable Devices

Automotive Devices

Table A1 — Product Series - Current Rating, Voltage Rating/Typical Resistance (Cont'd)

Voltage Rating	femtoASMDC 15V	femtoASMDC 12V	picoASMDC 15V	nanoASMDC 60V	nanoASMDC 48V	nanoASMDC 24V	nanoASMDC 16V	nanoASMDC 13.2V	microASMD 30V	microASMD 13.2V
Hold Current (A)										
0.05	16.90Ω	—	—	—	—	—	—	—	26.80Ω	—
0.08	—	8.40Ω	—	—	—	—	—	—	—	—
0.10	8.00Ω	—	6.25Ω	8.30Ω	—	—	—	—	8.55Ω	—
0.12	—	—	5.25Ω	—	3.95Ω	—	—	—	—	—
0.16	—	—	—	—	3.05Ω	—	—	—	—	—
0.20	—	—	—	—	—	1.875Ω	—	—	—	—
0.25	—	—	—	—	—	—	1.25Ω	—	—	—
0.35	—	—	—	—	—	—	0.90Ω	—	—	—
0.50	—	—	—	—	—	—	—	0.475Ω	—	0.575Ω

Voltage Rating	miniASMDC 60V	miniASMDC 33V	miniASMDC 30V	miniASMDC 24V	miniASMDC 16V	miniASMDC 13.2V	miniASMDC 12V	ASMDC 60V	ASMDC 33V	ASMDC 24V	nanoASMDCH 16V
Hold Current (A)											
0.10	6.70Ω	—	—	—	—	—	—	—	—	—	—
0.14	3.75Ω	—	—	—	—	—	—	—	—	—	—
0.20	—	—	1.950Ω	—	—	—	—	—	—	—	—
0.30	—	—	0.975Ω	—	—	—	—	1.850Ω	—	—	—
0.35	—	—	—	—	—	—	—	—	—	—	0.90Ω
0.50	—	—	—	0.575Ω	—	—	—	0.675Ω	—	—	—
0.75	—	0.25Ω	—	0.190Ω	—	0.280Ω	—	—	0.355Ω	—	—
1.10	—	—	—	0.120Ω	0.1200Ω	—	—	—	—	—	—
1.25	—	—	—	—	0.0950Ω	—	—	—	0.145Ω	—	—
1.50	—	—	—	0.080Ω	0.0750Ω	—	0.075Ω	—	—	—	—
1.85	—	—	—	—	—	—	—	—	0.100Ω	—	—
2.00	—	—	—	—	0.0525Ω	—	—	—	—	—	—
2.60	—	—	—	—	0.0325Ω	0.0325Ω	0.031Ω	—	—	—	—
3.00	—	—	—	—	—	—	—	—	—	0.0435Ω	—

PolySwitch Resettable Devices

Automotive Devices

Table A2 – Thermal Derating [Hold Current (A) at Ambient Temperature (°C)]

Part Number	Maximum Ambient Temperature										
	-40°C	-20°C	0°C	20°C	25°C	40°C	50°C	60°C	70°C	85°C	125°C
AGRF (High Temperature)											
16V — Radial-leaded											
AGRF400	5.9	5.3	4.8	4.1	4.0	3.5	3.2	2.8	2.5	1.9	—
AGRF500	7.3	6.6	6.0	5.2	5.0	4.4	4.0	3.6	3.1	2.4	—
AGRF600	8.8	8.0	7.2	6.2	6.0	5.2	4.8	4.2	3.8	2.8	—
AGRF700	10.3	9.3	8.4	7.3	7.0	6.2	5.6	5.0	4.4	3.3	—
AGRF800	11.7	10.7	9.6	8.3	8.0	6.9	6.4	5.6	5.1	3.7	—
AGRF900	13.2	11.9	10.7	9.4	9.0	7.9	7.2	6.4	5.6	4.2	—
AGRF1000	14.7	13.3	12.0	10.3	10.0	8.7	8.0	7.0	6.3	4.7	—
AGRF1100	16.1	14.6	13.1	11.5	11.0	9.7	8.8	7.8	6.9	5.2	—
AGRF1200	17.6	16.0	14.4	12.4	12.0	10.4	9.6	8.4	7.6	5.6	—
AGRF1400	20.5	18.7	16.8	14.5	14.0	12.1	11.2	9.8	8.9	6.5	—
AHRF (High Temperature)											
30V — Radial-leaded											
AHRF050	0.7	0.6	0.6	0.5	0.5	0.4	0.4	0.4	0.3	0.3	0.1
AHRF070	1.0	0.9	0.8	0.7	0.7	0.6	0.6	0.5	0.5	0.4	0.2
AHRF100	1.4	1.2	1.1	1.0	1.0	0.9	0.8	0.7	0.7	0.6	0.2
AHRF (High Temperature)											
16V — Radial-leaded											
AHRF200	2.7	2.5	2.3	2.1	2.0	1.8	1.6	1.5	1.3	1.1	0.5
AHRF300	4.1	3.7	3.4	3.1	3.0	2.7	2.4	2.2	2.0	1.7	0.7
AHRF400	5.6	5.1	4.7	4.2	4.0	3.6	3.3	3.0	2.7	2.3	1.0
AHRF450	6.1	5.6	5.1	4.6	4.5	4.0	3.6	3.3	3.0	2.5	1.1
AHRF550	7.5	6.9	6.2	5.7	5.5	4.9	4.4	4.0	3.7	3.1	1.4
AHRF600	8.2	7.5	6.8	6.2	6.0	5.3	4.9	4.4	4.0	3.3	1.5
AHRF650	8.8	8.1	7.4	6.7	6.5	5.7	5.3	4.8	4.3	3.6	1.6
AHRF700	9.5	8.7	8.0	7.2	7.0	6.2	5.6	5.2	4.7	3.9	1.7
AHRF750	10.2	9.4	8.6	7.7	7.5	6.6	6.1	5.6	5.0	4.1	1.9
AHRF800	10.9	10.0	9.1	8.2	8.0	7.1	6.4	5.9	5.3	4.4	2.0
AHRF900	12.2	11.2	10.2	9.3	9.0	8.0	7.2	6.6	6.0	5.0	2.2
AHRF1000	13.6	12.5	11.4	10.3	10.0	8.8	8.1	7.4	6.6	5.5	2.5
AHRF1100	14.9	13.7	12.5	11.3	11.0	9.7	8.8	8.1	7.3	6.1	2.7
AHRF1300	17.7	16.3	14.8	13.4	13.0	11.4	10.5	9.6	8.6	7.2	3.3
AHRF1400	19.0	17.5	15.9	14.4	14.0	12.4	11.2	10.3	9.3	7.8	3.5
AHRF1500	20.4	18.8	17.1	15.5	15.0	13.2	12.1	11.1	9.9	8.3	3.8
AHEF (High Temperature)											
32V — Radial-leaded											
AHEF050	0.7	0.6	0.60	0.5	0.5	0.4	0.400	0.40	0.30	0.300	0.1
AHEF070	1.0	0.9	0.80	0.7	0.7	0.6	0.600	0.50	0.50	0.400	0.2
AHEF100	1.4	1.2	1.10	1.0	1.0	0.9	0.800	0.70	0.70	0.600	0.2
AHEF300	4.1	3.8	3.42	3.1	3.0	2.7	2.430	2.22	1.98	1.650	0.6
AHEF500	6.8	6.3	5.70	5.2	5.0	4.5	4.050	3.70	3.30	2.750	1.0
AHEF750	10.2	9.4	8.55	7.7	7.5	6.7	6.075	5.55	4.95	4.125	1.5
AHEF1000	13.6	12.5	11.40	10.3	10.0	8.9	8.100	7.40	6.60	5.500	2.0
AHS (High Temperature)											
16V — Surface-mount											
AHS080-2018	1.20	1.04	0.90	0.8	0.77	0.68	0.62	0.60	0.53	0.46	0.26
AHS120	1.72	1.54	1.36	1.2	1.14	1.01	0.92	0.83	0.74	0.61	0.25
AHS160	2.15	1.96	1.78	1.6	1.55	1.42	1.33	1.24	1.15	1.01	0.64
AHS200	2.90	2.50	2.20	2.0	1.94	1.80	1.75	1.70	1.40	1.18	0.67
AHS300	4.20	3.80	3.70	3.0	2.92	2.63	2.44	2.10	2.00	1.76	1.00

PolySwitch Resettable Devices

Automotive Devices

Table A2 – Thermal Derating [Hold Current (A) at Ambient Temperature (°C)]

(Cont'd)

Part Number	Maximum Ambient Temperature										
	-40°C	-20°C	0°C	20°C	25°C	40°C	50°C	60°C	70°C	85°C	125°C
ASMD											
16-60V — Surface-mount											
ASMD030F	0.35	0.31	0.27	0.23	0.22	0.19	0.17	0.15	0.13	0.11	—
ASMD050F	0.59	0.53	0.46	0.39	0.37	0.33	0.29	0.26	0.23	0.18	—
ASMD075F	0.91	0.81	0.71	0.60	0.58	0.50	0.45	0.40	0.35	0.28	—
ASMD100F	1.37	1.22	1.06	0.90	0.86	0.76	0.68	0.60	0.52	0.41	—
ASMD125F	1.58	1.40	1.23	1.04	1.00	0.87	0.78	0.70	0.60	0.48	—
ASMD150F	1.93	1.70	1.50	1.27	1.22	1.07	0.95	0.85	0.74	0.58	—
ASMD150F/33	1.96	1.73	1.50	1.26	1.20	1.03	0.91	0.80	0.68	0.51	—
ASMD185F	2.93	2.58	2.30	1.93	1.85	1.62	1.44	1.30	1.12	0.88	—
ASMD200F	2.63	2.34	2.04	1.73	1.66	1.45	1.30	1.16	1.00	0.80	—
ASMD250F	3.00	2.66	2.32	1.97	1.89	1.65	1.48	1.32	1.14	0.91	—
femtoASMD											
12-15V — Surface-mount											
femtoASMD005F	0.08	0.07	0.06	0.05	0.05	0.04	0.04	0.03	0.03	0.02	—
femtoASMD008F	0.13	0.11	0.10	0.08	0.08	0.07	0.06	0.06	0.05	0.04	—
femtoASMD010F/15	0.16	0.14	0.12	0.11	0.10	0.09	0.08	0.07	0.06	0.04	—
picoASMD											
15V — Surface-mount											
picoASMD010S	0.17	0.15	0.13	0.11	0.10	0.09	0.08	0.07	0.06	0.05	—
picoASMD012S	0.20	0.17	0.15	0.13	0.12	0.10	0.09	0.08	0.07	0.05	—
nanoASMD											
13.2-48V—Surface-mount											
nanoASMD010F	0.15	0.14	0.12	0.10	0.10	0.09	0.08	0.07	0.06	0.05	—
nanoASMD012F	0.20	0.17	0.15	0.13	0.12	0.11	0.10	0.09	0.08	0.07	—
nanoASMD016F	0.21	0.20	0.18	0.16	0.16	0.14	0.13	0.12	0.11	0.09	—
nanoASMD020F	0.34	0.30	0.26	0.22	0.20	0.17	0.15	0.13	0.11	0.08	—
nanoASMD025F	0.38	0.33	0.30	0.26	0.25	0.22	0.20	0.19	0.16	0.11	—
nanoASMD035F	0.58	0.51	0.44	0.38	0.35	0.31	0.28	0.24	0.21	0.16	—
nanoASMD050F/13.2	0.78	0.69	0.61	0.52	0.50	0.44	0.39	0.35	0.30	0.24	—
microASMD											
13.2-30V — Surface-mount											
microASMD005F	0.08	0.07	0.06	0.05	0.05	0.04	0.04	0.03	0.03	0.02	—
microASMD010F	0.15	0.13	0.12	0.10	0.10	0.09	0.08	0.06	0.06	0.05	—
microASMD050F	0.76	0.66	0.58	0.50	0.48	0.42	0.38	0.35	0.29	0.23	—
miniASMD											
16-60V — Surface-mount											
miniASMD010F	0.17	0.15	0.13	0.11	0.10	0.09	0.08	0.07	0.06	0.04	—
miniASMD014F	0.23	0.20	0.17	0.14	0.13	0.11	0.10	0.09	0.07	0.05	—
miniASMD020F	0.30	0.27	0.23	0.20	0.19	0.17	0.15	0.13	0.12	0.09	—
miniASMD030F	0.49	0.44	0.39	0.32	0.30	0.27	0.24	0.22	0.18	0.14	—
miniASMD050F	0.59	0.57	0.55	0.50	0.48	0.45	0.43	0.35	0.30	0.23	—
miniASMD075F	1.10	0.99	0.87	0.75	0.72	0.63	0.57	0.49	0.45	0.35	—
miniASMD075F/24	1.50	1.25	1.00	0.75	0.73	0.65	0.60	0.55	0.50	0.43	—
miniASMD075F/33	1.09	0.98	0.87	0.77	0.75	0.66	0.61	0.55	0.50	0.41	—
miniASMD110F/16	1.68	1.49	1.30	1.10	1.05	0.92	0.83	0.75	0.64	0.50	—
miniASMD110F/24	2.00	1.70	1.40	1.10	1.06	0.95	0.88	0.80	0.73	0.61	—
miniASMD125F/16	2.00	1.69	1.47	1.25	1.17	1.03	0.92	0.90	0.69	0.53	—
miniASMD150F/12	2.40	2.10	1.80	1.50	1.44	1.25	1.13	1.00	0.88	0.69	—

PolySwitch Resettable Devices

Automotive Devices

Table A2 – Thermal Derating [Hold Current (A) at Ambient Temperature (°C)]

(Cont'd)

Part Number	Maximum Ambient Temperature										
	-40°C	-20°C	0°C	20°C	25°C	40°C	50°C	60°C	70°C	85°C	125°C
miniASMDC											
16-60V — Surface-mount											
miniASMDC150F/16	2.40	2.10	1.80	1.50	1.44	1.25	1.13	1.00	0.88	0.69	—
miniASMDC150F/24	2.10	1.90	1.70	1.50	1.44	1.25	1.13	1.00	0.88	0.69	—
miniASMDC200F/16	3.07	2.74	2.40	2.07	2.00	1.74	1.57	1.40	1.24	0.99	—
miniASMDC260F/12	3.40	3.16	3.00	2.60	2.54	2.32	2.18	2.00	1.90	1.69	—
miniASMDC260F/13.2	3.40	3.16	3.00	2.60	2.54	2.32	2.18	2.00	1.90	1.69	—
miniASMDC260F/16	3.50	3.20	3.00	2.60	2.53	2.30	2.15	2.00	1.85	1.63	—
ASMDC											
24-60V — Surface-mount											
ASMDC030F	0.49	0.43	0.37	0.31	0.30	0.25	0.22	0.19	0.16	0.12	—
ASMDC050F	0.86	0.75	0.65	0.54	0.50	0.43	0.37	0.32	0.26	0.18	—
ASMDC075F	1.17	1.04	0.90	0.77	0.75	0.64	0.57	0.50	0.44	0.34	—
ASMDC125F/33	2.02	1.78	1.55	1.31	1.25	1.08	0.96	0.84	0.72	0.54	—
ASMDC185F/33	2.83	2.50	2.20	1.85	1.74	1.53	1.37	1.22	1.04	0.80	—
ASMDC300F/24	4.70	4.19	3.70	3.17	3.00	2.66	2.41	2.20	1.90	1.50	—
nanoASMDC											
16V—Surface-mount											
nanoASMDCH035F	0.54	0.48	0.43	0.37	0.35	0.32	0.29	0.26	0.24	0.20	0.10

Figures A1-A4 – Thermal Derating Curves

- A = AGRF
- B = AHRF

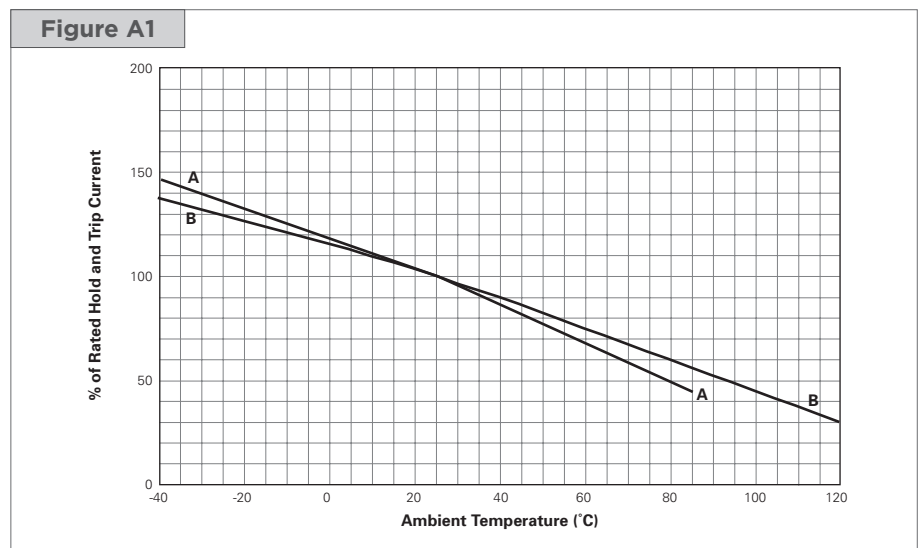

PolySwitch Resettable Devices

Automotive Devices

Figures A1-A4 – Thermal Derating Curves

(Cont'd)

AHEF



A = ASMD, femtoASMD, nanoASMD, microASMD, miniASMD, ASMD

B = AHS

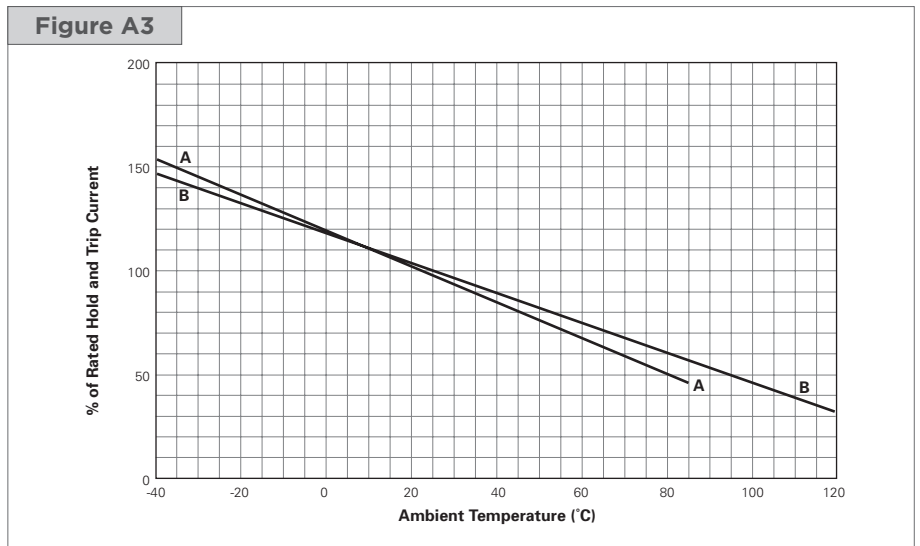

nanoASMDCH

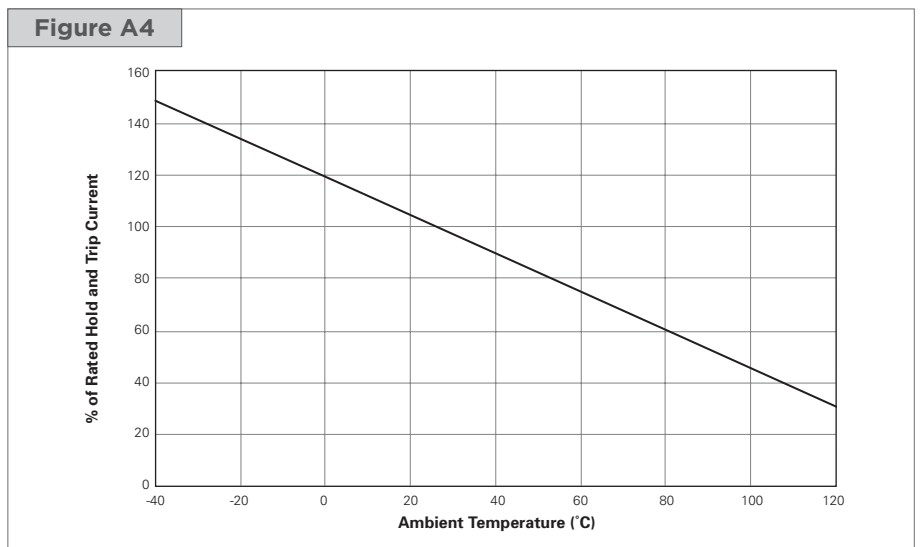

PolySwitch Resettable Devices

Automotive Devices

Table A3 – Electrical Characteristics

Part Number	$I_{IH}(A)@$	$I_{IH}(A)@$	I_T (A)	V_{MAX} (V_{DC})	I_{MAX} (A)	$P_{D\ TYP}$ (W)	Max. Time-to-trip		R_{MIN} (Ω)	R_{1MAX} (Ω)	R_{2MAX} (Ω)	Figure for Dimensions
	R_{1MAX}	R_{2MAX}					(A)	(s)				
AGRF												
16V — Radial-leaded												
AGRF400	4.0	3.0	7.6	16	100	2.5	20.0	2.0	0.0186	0.0610	0.0850	A5, A8, A9
AGRF500	5.0	4.3	9.4	16	100	2.7	25.0	2.5	0.0140	0.0340	0.0480	A5, A8, A9
AGRF600	6.0	5.3	10.7	16	100	2.8	30.0	3.5	0.0095	0.0280	0.0320	A5, A8, A9
AGRF700	7.0	6.5	13.2	16	100	3.0	35.0	4.0	0.0066	0.0200	0.0220	A5, A8, A9
AGRF800	8.0	7.6	15.0	16	100	3.2	40.0	5.5	0.0049	0.0175	0.0181	A5, A8, A9
AGRF900	9.0	8.6	16.5	16	100	3.4	45.0	6.0	0.0041	0.0135	0.0140	A5, A8, A9
AGRF1000	10.0	9.6	18.5	16	100	3.6	50.0	7.0	0.0034	0.0102	0.0106	A5, A8, A9
AGRF1100	11.0	10.5	20.3	16	100	3.7	55.0	7.5	0.0033	0.0089	0.0093	A5, A8, A9
AGRF1200	12.0	11.5	22.1	16	100	4.2	60.0	8.0	0.0030	0.0086	0.0091	A5, A8, A9
AGRF1400	14.0	13.0	27.3	16	100	4.6	70.0	9.0	0.0022	0.0064	0.0067	A5, A8, A9
AHRF (High Temperature)												
30V — Radial-leaded												
AHRF050	0.5	0.5	1.0	30	40	0.9	2.5	3.0	0.3500	1.100	1.100	A8, A9, A10
AHRF070	0.7	0.7	1.4	30	40	1.4	3.5	3.2	0.2300	0.800	0.800	A8, A9, A11
AHRF100	1.0	1.0	1.9	30	40	1.4	5.0	6.2	0.1500	0.430	0.430	A8, A9, A10
AHRF (High Temperature)												
16V — Radial-leaded												
AHRF200	2.0	2.0	3.8	16	100	1.4	10.0	4.8	0.0390	0.1100	0.1100	A8, A9, A10
AHRF300	3.0	3.0	6.5	16	100	3.0	15.0	5.0	0.0290	0.0790	0.0790	A5, A8, A9
AHRF400	4.0	4.0	7.4	16	100	3.3	20.0	5.0	0.0210	0.0600	0.0600	A5, A8, A9
AHRF450	4.5	4.5	8.7	16	100	3.6	22.5	4.0	0.0170	0.0540	0.0540	A5, A8, A9
AHRF550	5.5	5.5	10.0	16	100	3.5	27.5	6.0	0.0130	0.0370	0.0370	A5, A8, A9
AHRF600	6.0	6.0	12.0	16	100	4.1	30.0	6.5	0.0100	0.0320	0.0320	A5, A8, A9
AHRF650	6.5	6.5	13.7	16	100	4.3	32.5	7.0	0.0090	0.0260	0.0260	A5, A8, A9
AHRF700	7.0	7.0	13.1	16	100	4.0	35.0	7.0	0.0087	0.0250	0.0250	A5, A8, A9
AHRF750	7.5	7.5	14.8	16	100	4.5	37.5	8.0	0.0074	0.0220	0.0220	A5, A8, A9
AHRF800	8.0	8.0	15.0	16	100	4.2	40.0	8.0	0.0072	0.0200	0.0200	A5, A8, A9
AHRF900	9.0	9.0	18.5	16	100	5.0	45.0	11.5	0.0061	0.0170	0.0170	A5, A8, A9
AHRF1000	10.0	10.0	20.5	16	100	5.3	50.0	10.5	0.0051	0.0150	0.0150	A5, A8, A9
AHRF1100	11.0	11.0	21.2	16	100	5.5	55.0	11.0	0.0048	0.0130	0.0130	A5, A8, A9
AHRF1300	13.0	13.0	27.0	16	100	6.9	65.0	15.0	0.0034	0.0100	0.0100	A5, A8, A9
AHRF1400	14.0	14.0	28.3	16	100	6.9	70.0	15.5	0.0029	0.0090	0.0090	A5, A8, A9
AHRF1500	15.0	15.0	33.0	16	100	7.0	75.0	20.0	0.0027	0.0092	0.0092	A5, A8, A9
AHEF (High Temperature)												
32V — Radial-leaded												
AHEF050	0.5	0.5	1.0	32	100	0.9	2.5	3.0	0.3500	1.100	1.100	A8, A9, A10
AHEF070	0.7	0.7	1.4	32	100	1.4	3.5	3.2	0.2300	0.800	0.800	A8, A9, A11
AHEF100	1.0	1.0	1.9	32	100	1.4	5.0	6.2	0.1500	0.430	0.430	A8, A9, A10
AHEF300	3.0	3.0	6.0	32	100	3.2	15.0	5.0	0.0350	0.110	0.110	A8, A9, A12
AHEF500	5.0	5.0	10.0	32	100	5.3	25.0	9.0	0.0150	0.040	0.040	A8, A9, A12
AHEF750	7.5	7.5	15.0	32	100	6.5	37.5	13.0	0.0074	0.023	0.023	A8, A9, A12
AHEF1000	10.0	10.0	20.0	32	100	7.0	50.0	15.0	0.0060	0.016	0.016	A8, A9, A12
AHS (High Temperature)												
16V — Surface-mount												
AHS080-2018	0.80	0.80	2.00	16	70	1.5	8.0	9.0	0.130	0.550	0.550	A6
AHS120	1.20	1.20	2.30	16	50	2.2	8.0	2.0	0.150	0.340	0.340	A7
AHS160	1.60	1.60	3.20	16	70	2.2	8.0	15.0	0.050	0.150	0.150	A7
AHS200	2.00	2.00	4.00	16	70	2.3	8.0	13.4	0.050	0.140	0.140	A7
AHS300	3.00	3.00	6.00	16	70	3.0	15.0	8.0	0.024	0.083	0.083	A7

PolySwitch Resettable Devices

Automotive Devices

Table A3 – Electrical Characteristics

(Cont'd)

Part Number	$I_H(A)@$	$I_H(A)@$	I_T	V_{MAX}	I_{MAX}	$P_{D\ TYP}$	Max. Time-to-trip		R_{MIN}	R_{TMAX}	R_{BMAX}	Figure for Dimensions
	R_{TMAX}	R_{BMAX}					(A)	(s)				
ASMD												
16-60V — Surface-mount												
ASMD030F	0.23	0.23	0.59	60	10	1.1	1.15	12.0	0.980	4.800	4.800	A7
ASMD050F	0.37	0.37	0.98	60	10	1.7	1.95	20.0	0.290	1.400	1.400	A7
ASMD075F	0.60	0.60	1.48	30	40	1.1	3.00	20.0	0.290	1.000	1.000	A7
ASMD100F	0.90	0.90	2.16	30	40	1.1	4.50	20.0	0.098	0.480	0.480	A7
ASMD125F	1.04	1.04	2.46	16	40	1.1	5.20	20.0	0.057	0.250	0.250	A7
ASMD150F	1.27	1.27	2.95	16	40	1.2	6.35	25.0	0.049	0.250	0.250	A7
ASMD150F/33	1.20	1.20	2.88	33	40	1.9	6.00	14.0	0.068	0.230	0.230	A7
ASMD185F	1.85	1.85	3.70	16	40	1.5	9.25	11.3	0.032	0.126	0.126	A7
ASMD200F	1.73	1.73	3.93	16	40	1.2	8.65	30.0	0.050	0.120	0.120	A7
ASMD250F	1.97	1.97	5.00	16	40	1.2	9.85	30.0	0.035	0.085	0.085	A7
femtoASMD												
12-15V — Surface-mount												
femtoASMD005F	0.05	0.05	0.15	15	10	0.50	0.50	0.10	3.80	30.00	30.00	A13
femtoASMD008F	0.08	0.08	0.20	12	10	0.50	0.60	0.10	2.80	14.00	14.00	A13
femtoASMD010F/15	0.10	0.10	0.30	15	10	0.50	0.70	0.10	2.00	14.00	14.00	A13
picoASMD												
15V — Surface-mount												
picoASMD010S	0.10	0.10	0.30	15	20	0.50	0.50	0.60	1.50	11.00	11.00	A13
picoASMD012S	0.12	0.12	0.30	15	20	0.50	1.00	0.10	1.50	9.00	9.00	A13
nanoASMD												
13.2-48V — Surface-mount												
nanoASMD010F	0.10	0.10	0.25	60	10	0.80	0.50	1.00	1.60	15.00	15.00	A13
nanoASMD012F	0.12	0.12	0.39	48	10	0.50	1.00	0.20	1.40	6.50	6.50	A13
nanoASMD016F	0.16	0.16	0.45	48	10	0.50	1.00	0.30	1.10	5.00	5.00	A13
nanoASMD020F	0.20	0.20	0.42	24	100	0.60	8.00	0.10	0.65	3.10	3.10	A13
nanoASMD025F	0.25	0.25	0.58	16	100	0.60	8.00	0.01	0.40	2.10	2.10	A13
nanoASMD035F	0.35	0.75	0.75	16	20	0.60	3.50	0.10	0.45	1.35	1.35	A13
nanoASMD050F/13.2	0.50	0.50	1.10	13.2	70	0.80	8.00	0.10	0.20	0.75	0.75	A13
microASMD												
13.2-30V — Surface-mount												
microASMD005F	0.05	0.05	0.15	30	10	1.00	0.25	1.50	3.60	50.00	50.00	A13
microASMD010F	0.10	0.10	0.25	30	10	0.80	0.50	1.00	2.10	15.00	15.00	A13
microASMD050F	0.50	0.50	1.00	13.2	40	0.80	8.00	0.05	0.25	0.90	0.90	A13
miniASMD												
12-60V — Surface-mount												
miniASMD010F	0.10	0.10	0.30	60	40	0.75	0.50	5.00	0.70	12.70	12.70	A13
miniASMD014F	0.14	0.14	0.28	60	10	0.75	8.00	0.01	1.50	6.00	6.00	A13
miniASMD020F	0.20	0.20	0.40	30	10	0.80	8.00	0.02	0.60	3.30	3.30	A13
miniASMD030F	0.30	0.30	0.60	30	40	0.80	8.00	0.10	0.20	1.75	1.75	A13
miniASMD050F	0.50	0.50	1.00	24	100	0.80	8.00	0.15	0.15	1.00	1.00	A13
miniASMD075F	0.75	0.75	1.50	13.2	100	1.00	8.00	0.20	0.11	0.45	0.45	A13
miniASMD075F/24	0.75	0.75	1.50	24	40	0.80	8.00	0.30	0.09	0.29	0.29	A13
miniASMD075F/33	0.75	0.75	1.60	33	100	1.00	8.00	1.00	0.11	0.39	0.39	A13
miniASMD110F/16	1.10	1.10	2.20	16	100	0.80	8.00	0.30	0.06	0.18	0.18	A13
miniASMD110F/24	1.10	1.10	2.20	24	20	0.80	8.00	0.50	0.06	0.18	0.18	A13
miniASMD125F/16	1.25	1.25	2.50	16	100	0.80	8.00	0.40	0.05	0.14	0.14	A13
miniASMD150F/12	1.50	1.50	2.80	12	100	0.80	8.00	0.50	0.04	0.11	0.11	A13
miniASMD150F/16	1.50	1.50	2.80	16	100	0.80	8.00	0.50	0.04	0.11	0.11	A13
miniASMD150F/24	1.50	1.50	3.00	24	20	1.00	8.00	1.50	0.04	0.12	0.12	A13
miniASMD200F/16	2.00	2.00	4.00	16	40	1.20	8.00	5.00	0.02	0.085	0.085	A13
miniASMD260F/12	2.60	2.60	5.00	12	100	1.00	8.00	5.00	0.015	0.047	0.047	A13
miniASMD260F/13.2	2.60	2.60	5.00	13.2	100	1.20	8.00	5.00	0.015	0.05	0.05	A13
miniASMD260F/16	2.60	2.60	5.00	16	100	1.20	8.00	5.00	0.015	0.05	0.05	A13

PolySwitch Resettable Devices

Automotive Devices

Table A3 – Electrical Characteristics

(Cont'd)

Part Number	I_H (A)@	I_H (A)@	I_T (A)	V_{MAX} (V _{DC})	I_{MAX} (A)	$P_{D\ TYP}$ (W)	Max. Time-to-trip		R_{MIN} (Ω)	R_{1MAX} (Ω)	R_{2MAX} (Ω)	Figure for Dimensions
	R_{1MAX}	R_{2MAX}					(A)	(s)				
ASMDC												
24-60V — Surface-mount												
ASMDC030F	0.30	0.30	0.60	60	10	1.50	1.50	3.00	0.30	3.40	3.40	A13
ASMDC050F	0.50	0.50	1.00	60	10	1.50	2.50	4.00	0.15	1.20	1.20	A13
ASMDC075F	0.75	0.75	1.50	33	40	1.50	8.00	0.30	0.10	0.61	0.61	A13
ASMDC125F/33	1.25	1.25	2.50	33	40	1.50	8.00	2.00	0.04	0.25	0.25	A13
ASMDC185F/33	1.85	1.85	3.70	33	40	1.70	8.00	2.50	0.05	0.15	0.15	A13
ASMDC300F/24	3.00	3.00	6.00	24	40	1.70	8.00	5.00	0.015	0.072	0.072	A13
nanoASMDCH												
16V — Surface-mount												
nanoASMDCH035F	0.35	0.35	0.95	16	50	1.00	3.50	0.20	0.20	1.60	1.60	A13

Notes:

- I_H : Hold current: maximum current device will pass without interruption in 25°C, unless otherwise specified (20°C for ASMD).
- I_T : Trip current: minimum current that will switch the device from low-resistance to high-resistance in 25°C still air, unless otherwise specified.
- V_{MAX} : Maximum voltage device can withstand without damage at rated current.
- I_{MAX} : Maximum fault current device can withstand without damage at rated voltage.
- P_D : Power dissipated from device when in the tripped state in 25°C still air, unless otherwise specified.
- R_{MIN} : Minimum resistance of device as supplied at 25°C, unless otherwise specified.
- R_{1MAX} : Maximum resistance of device when measured one hour post reflow (surface-mount device) or one hour post trip (radial-leaded device) at 25°C unless otherwise specified.
- R_{2MAX} : Maximum functional resistance of device after being subjected to the stresses described in PS400 at 25°C, unless otherwise specified.
- R_{3MIN} : Minimum functional resistance of device after being subjected to the stresses described in PS400 at 25°C, unless otherwise specified.

Figures A5-A13 – Dimension Figures



PolySwitch Resettable Devices

Automotive Devices

Figures A5-A13 — Dimension Figures

(Cont'd)

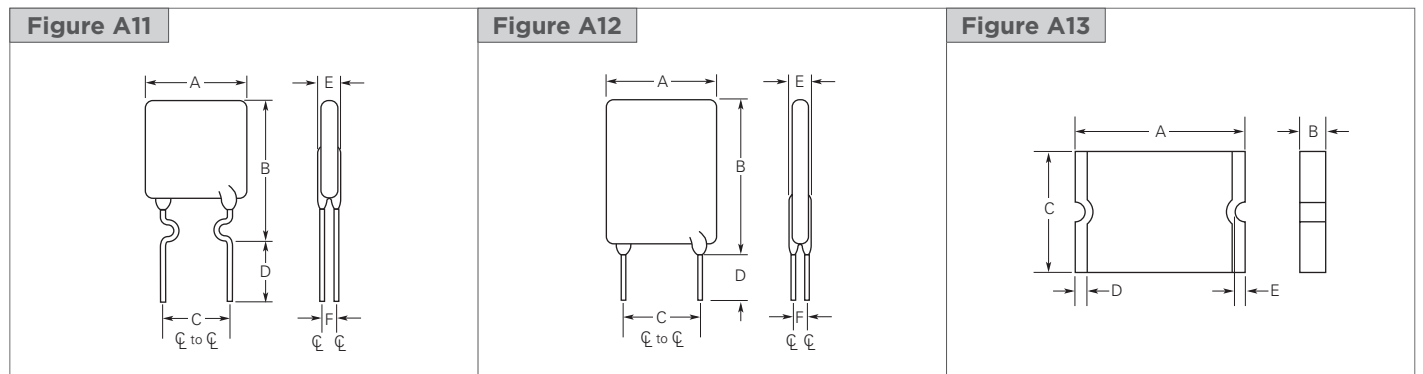

Table A4 — Dimensions in Millimeters and (Inches)

Part Number	A		B		C		D		E		F		G		H	J	Figure
	Min	Max	Min	Max	Min	Max	Min	Max	Min	Max	Min	Max	Min	Max	Typ	Max	
AGRF																	
16V — Radial-leaded																	
AGRF400	—	8.9	—	14.1	4.3	5.8	7.6	—	—	3.0	1.2	—	—	3.10	1.24	1.4	A5, A8, A9
		(0.350)		(0.56)	(0.17)	(0.20)	(0.3)			(0.12)	(0.15)			(0.120)	(0.049)	(0.06)	
AGRF500	—	10.4	—	15.6	4.3	5.8	7.6	—	—	3.0	1.2	—	—	3.94	1.24	1.6	A5, A8, A9
		(0.410)		(0.61)	(0.17)	(0.20)	(0.3)			(0.12)	(0.05)			(0.155)	(0.049)	(0.06)	
AGRF600	—	10.7	—	18.4	4.3	5.8	7.6	—	—	3.0	1.2	—	—	4.07	1.24	1.6	A5, A8, A9
		(0.420)		(0.73)	(0.17)	(0.20)	(0.3)			(0.12)	(0.05)			(0.160)	(0.049)	(0.06)	
AGRF700	—	11.2	—	21.0	4.3	5.8	7.6	—	—	3.0	1.2	—	—	4.49	1.24	1.7	A5, A8, A9
		(0.440)		(0.73)	(0.17)	(0.20)	(0.3)			(0.12)	(0.05)			(0.177)	(0.049)	(0.07)	
AGRF800	—	12.7	—	22.2	4.3	5.8	7.6	—	—	3.0	1.2	—	—	5.08	1.24	1.8	A5, A8, A9
		(0.500)		(0.88)	(0.17)	(0.20)	(0.3)			(0.12)	(0.05)			(0.200)	(0.049)	(0.07)	
AGRF900	—	14.0	—	23.0	4.3	5.8	7.6	—	—	3.0	1.2	—	—	5.69	1.24	2.0	A5, A8, A9
		(0.550)		(0.91)	(0.17)	(0.20)	(0.3)			(0.12)	(0.05)			(0.224)	(0.049)	(0.08)	
AGRF1000	—	16.51	—	25.7	4.3	5.8	7.6	—	—	3.0	1.2	—	—	6.96	1.24	2.0	A5, A8, A9
		(0.650)		(1.01)	(0.17)	(0.20)	(0.3)			(0.12)	(0.05)			(0.274)	(0.049)	(0.08)	
AGRF1100	—	17.5	—	26.5	4.3	5.8	7.6	—	—	3.0	1.2	—	—	7.47	1.24	2.4	A5, A8, A9
		(0.690)		(1.04)	(0.17)	(0.20)	(0.3)			(0.12)	(0.05)			(0.294)	(0.049)	(0.09)	
AGRF1200	—	17.5	—	28.8	9.4	10.9	7.6	—	—	3.5	1.4	—	—	4.83	1.45	1.5	A5, A8, A9
		(0.690)		(1.14)	(0.37)	(0.43)	(0.3)			(0.14)	(0.06)			(0.190)	(0.057)	(0.06)	
AGRF1400	—	23.5	—	28.7	9.4	10.9	7.6	—	—	3.5	1.4	—	—	7.82	1.45	1.9	A5, A8, A9
		(0.925)		(1.13)	(0.37)	(0.43)	(0.3)			(0.14)	(0.06)			(0.308)	(0.057)	(0.07)	
AHRF (High Temperature)																	
30V — Radial-leaded																	
AHRF050	—	7.4	—	12.7	4.3	5.8	7.6	—	—	3.3	1.2	—	—	—	1.24	1.6	A8, A9, A10
		(0.29)		(0.50)	(0.17)	(0.23)	(0.30)			(0.13)	(0.05)				(0.049)	(0.06)	
AHRF070	—	6.9	—	10.8	4.3	5.8	7.6	—	—	3.3	1.2	—	—	—	1.24	1.6	A8, A9, A11
		(0.27)		(0.43)	(0.17)	(0.23)	(0.30)			(0.13)	(0.05)				(0.049)	(0.06)	
AHRF100	—	9.7	—	13.6	4.3	5.8	7.6	—	—	3.0	1.2	—	—	—	1.24	1.6	A8, A9, A10
		(0.38)		(0.54)	(0.17)	(0.23)	(0.30)			(0.12)	(0.05)				(0.049)	(0.06)	

PolySwitch Resettable Devices

Automotive Devices

Table A4 — Dimensions in Millimeters and (Inches)

(Cont'd)

Part Number	A		B		C		D		E		F		G		H	J	Figure
	Min	Max	Min	Max	Min	Max	Min	Max	Min	Max	Min	Max	Min	Max	Typ	Max	
AHRF (High Temperature)																	
16V — Radial-leaded																	
AHRF200	—	9.4 (0.37)	—	14.4 (0.57)	4.3 (0.17)	5.8 (0.23)	7.6 (0.30)	—	—	3.0 (0.12)	1.2 (0.05)	—	—	—	1.24 (0.049)	1.6 (0.06)	A8, A9, A10
AHRF300	—	8.8 (0.35)	—	13.8 (0.55)	4.3 (0.17)	5.8 (0.23)	7.6 (0.30)	—	—	3.0 (0.12)	1.2 (0.05)	—	—	—	1.24 (0.049)	1.6 (0.06)	A5, A8, A9
AHRF400	—	10.0 (0.39)	—	15.0 (0.59)	4.3 (0.17)	5.8 (0.23)	7.6 (0.30)	—	—	3.0 (0.12)	1.2 (0.05)	—	—	—	1.24 (0.049)	1.6 (0.06)	A5, A8, A9
AHRF450	—	10.4 (0.41)	—	15.6 (0.61)	4.3 (0.17)	5.8 (0.23)	7.6 (0.30)	—	—	3.0 (0.12)	1.2 (0.05)	—	—	3.94 (0.155)	1.24 (0.049)	1.6 (0.06)	A5, A8, A9
AHRF550	—	11.2 (0.44)	—	18.9 (0.74)	4.3 (0.17)	5.8 (0.23)	7.6 (0.30)	—	—	3.0 (0.12)	1.2 (0.05)	—	—	—	1.24 (0.049)	1.6 (0.06)	A5, A8, A9
AHRF600	—	11.2 (0.44)	—	21.0 (0.73)	4.3 (0.17)	5.8 (0.23)	7.6 (0.30)	—	—	3.0 (0.12)	1.2 (0.05)	—	—	4.49 (0.177)	1.24 (0.049)	1.7 (0.07)	A5, A8, A9
AHRF650	—	12.7 (0.50)	—	22.2 (0.88)	4.3 (0.17)	5.8 (0.23)	7.6 (0.30)	—	—	3.0 (0.12)	1.2 (0.05)	—	—	5.08 (0.200)	1.24 (0.049)	1.8 (0.07)	A5, A8, A9
AHRF700	—	14.0 (0.55)	—	21.9 (0.86)	4.3 (0.17)	5.8 (0.23)	7.6 (0.30)	—	—	3.0 (0.12)	1.2 (0.05)	—	—	—	1.24 (0.049)	1.6 (0.06)	A5, A8, A9
AHRF750	—	14.0 (0.55)	—	23.5 (0.93)	4.3 (0.17)	5.8 (0.23)	7.6 (0.30)	—	—	3.0 (0.12)	1.2 (0.05)	—	—	5.69 (0.224)	1.24 (0.049)	2.0 (0.08)	A5, A8, A9
AHRF800	—	16.5 (0.65)	—	22.5 (0.88)	4.3 (0.17)	5.8 (0.23)	7.6 (0.30)	—	—	3.0 (0.12)	1.2 (0.05)	—	—	—	1.24 (0.049)	1.6 (0.06)	A5, A8, A9
AHRF900	—	16.5 (0.65)	—	25.7 (1.01)	4.3 (0.17)	5.8 (0.23)	7.6 (0.30)	—	—	3.0 (0.12)	1.2 (0.05)	—	—	—	—	—	A5, A8, A9
AHRF1000	—	17.5 (0.69)	—	26.5 (1.04)	9.4 (0.37)	10.9 (0.43)	7.6 (0.30)	—	—	3.0 (0.12)	1.2 (0.05)	—	—	7.47 (0.294)	1.24 (0.049)	1.5 (0.06)	A5, A8, A9
AHRF1100	—	21.0 (0.83)	—	26.1 (1.03)	9.4 (0.37)	10.9 (0.43)	7.6 (0.30)	—	—	3.0 (0.12)	1.2 (0.05)	—	—	—	1.24 (0.049)	1.6 (0.06)	A5, A8, A9
AHRF1300	—	23.5 (0.925)	—	28.7 (1.13)	9.4 (0.37)	10.9 (0.43)	7.6 (0.30)	—	—	3.5 (0.14)	1.4 (0.06)	—	—	7.82 (0.308)	1.45 (0.057)	1.9 (0.08)	A5, A8, A9
AHRF1400	—	23.5 (0.93)	—	28.7 (1.13)	9.4 (0.37)	10.9 (0.43)	7.6 (0.30)	—	—	3.6 (0.14)	1.4 (0.06)	—	—	—	1.24 (0.049)	1.6 (0.06)	A5, A8, A9
AHRF1500	—	23.5 (0.93)	—	28.7 (1.13)	9.4 (0.37)	10.9 (0.43)	7.6 (0.30)	—	—	3.5 (0.14)	1.4 (0.06)	—	—	7.82 (0.308)	—	—	A5, A8, A9
AHEF (High Temperature)																	
32V — Radial-leaded																	
AHEF050	—	7.4 (0.29)	—	12.7 (0.50)	4.3 (0.17)	5.8 (0.23)	7.6 (0.30)	—	—	3.3 (0.13)	—	—	—	—	—	—	A8, A9, A10
AHEF070	—	6.9 (0.27)	—	10.8 (0.43)	4.3 (0.17)	5.8 (0.23)	7.6 (0.30)	—	—	3.0 (0.12)	—	—	—	—	—	—	A8, A9, A11
AHEF100	—	9.7 (0.38)	—	13.6 (0.54)	4.3 (0.17)	5.8 (0.23)	7.6 (0.30)	—	—	3.0 (0.12)	—	—	—	—	—	—	A8, A9, A10
AHEF300	—	10.2 (0.40)	—	15.5 (0.61)	4.32 (0.17)	5.84 (0.23)	7.6 (0.30)	—	—	3.8 (0.15)	—	—	—	—	—	—	A8, A9, A12
AHEF500	—	14.0 (0.55)	—	24.1 (0.95)	4.3 (0.17)	5.8 (0.23)	11.5 (0.45)	—	—	3.8 (0.15)	—	—	—	—	—	—	A8, A9, A12
AHEF750	—	21.1 (0.83)	—	24.9 (0.98)	9.4 (0.37)	10.9 (0.43)	7.6 (0.30)	—	—	3.8 (0.15)	—	—	—	—	—	—	A8, A9, A12
AHEF1000	—	23.5 (0.93)	—	27.9 (1.10)	9.4 (0.37)	10.9 (0.43)	7.6 (0.30)	—	—	4.0 (0.16)	—	—	—	—	—	—	A8, A9, A12

PolySwitch Resettable Devices

Automotive Devices

Table A4 — Dimensions in Millimeters and (Inches)

(Cont'd)

Part Number	A		B		C		D		E		F		G		H		Figure
	Min	Max	Min	Max	Min	Max	Min	Max	Min	Max	Min	Max	Min	Max	Min	Max	
AHS (High Temperature)																	
16V — Surface-mount																	
AHS080-2018	4.72 (0.186)	5.44 (0.214)	—	1.52 (0.060)	4.22 (0.166)	4.93 (0.194)	0.25 (0.010)	0.36 (0.014)	0.25 (0.010)	0.36 (0.014)	0.30 (0.012)	0.46 (0.018)	—	—	—	—	A6
AHS120	6.73 (0.265)	7.98 (0.314)	—	3.00 (0.118)	4.8 (0.19)	5.44 (0.214)	0.56 (0.022)	0.71 (0.028)	0.56 (0.022)	0.71 (0.028)	2.16 (0.085)	2.41 (0.095)	0.66 (0.026)	1.37 (0.054)	0.43 (0.017)	—	A7
AHS160	8.00 (0.315)	9.40 (0.370)	—	3.00 (0.118)	6.0 (0.24)	6.71 (0.264)	0.56 (0.022)	0.71 (0.028)	0.56 (0.022)	0.71 (0.028)	3.68 (0.145)	3.94 (0.155)	0.66 (0.026)	1.37 (0.054)	0.43 (0.017)	—	A7
AHS200	8.00 (0.315)	9.40 (0.370)	—	3.00 (0.118)	6.0 (0.240)	6.71 (0.264)	0.56 (0.022)	0.71 (0.028)	0.56 (0.022)	0.71 (0.028)	3.68 (0.145)	3.94 (0.155)	0.66 (0.026)	1.37 (0.054)	0.43 (0.017)	—	A7
AHS300	8.00 (0.315)	9.40 (0.370)	—	3.00 (0.118)	6.0 (0.240)	6.71 (0.264)	0.56 (0.022)	0.71 (0.028)	0.56 (0.022)	0.71 (0.028)	3.68 (0.145)	3.94 (0.155)	0.66 (0.026)	1.37 (0.054)	0.43 (0.017)	—	A7
ASMD																	
16-60V — Surface-mount																	
ASMD030F	6.73 (0.265)	7.98 (0.314)	—	3.18 (0.125)	4.8 (0.19)	5.44 (0.214)	0.56 (0.022)	0.71 (0.028)	0.56 (0.022)	0.71 (0.028)	2.16 (0.085)	2.41 (0.095)	0.66 (0.026)	1.37 (0.054)	0.43 (0.017)	—	A7
ASMD050F	6.73 (0.265)	7.98 (0.314)	—	3.18 (0.125)	4.8 (0.19)	5.44 (0.214)	0.56 (0.022)	0.71 (0.028)	0.56 (0.022)	0.71 (0.028)	2.16 (0.085)	2.41 (0.095)	0.66 (0.026)	1.37 (0.054)	0.43 (0.017)	—	A7
ASMD075F	6.73 (0.265)	7.98 (0.314)	—	3.18 (0.125)	4.8 (0.19)	5.44 (0.214)	0.56 (0.022)	0.71 (0.028)	0.56 (0.022)	0.71 (0.028)	2.16 (0.085)	2.41 (0.095)	0.66 (0.026)	1.37 (0.054)	0.43 (0.017)	—	A7
ASMD100F	6.73 (0.265)	7.98 (0.314)	—	3.00 (0.118)	4.8 (0.19)	5.44 (0.214)	0.56 (0.022)	0.71 (0.028)	0.56 (0.022)	0.71 (0.028)	2.16 (0.085)	2.41 (0.095)	0.66 (0.026)	1.37 (0.054)	0.43 (0.017)	—	A7
ASMD125F	6.73 (0.265)	7.98 (0.314)	—	3.00 (0.118)	4.8 (0.19)	5.44 (0.214)	0.56 (0.022)	0.71 (0.028)	0.56 (0.022)	0.71 (0.028)	2.16 (0.085)	2.41 (0.095)	0.66 (0.026)	1.37 (0.054)	0.43 (0.017)	—	A7
ASMD150F	8.00 (0.315)	9.40 (0.370)	—	3.00 (0.118)	6.0 (0.24)	6.71 (0.264)	0.56 (0.022)	0.71 (0.028)	0.56 (0.022)	0.71 (0.028)	3.68 (0.145)	3.94 (0.155)	0.66 (0.026)	1.37 (0.054)	0.43 (0.017)	—	A7
ASMD150F/33	8.00 (0.315)	9.40 (0.370)	—	3.00 (0.118)	6.0 (0.24)	6.71 (0.264)	0.56 (0.022)	0.71 (0.028)	0.56 (0.022)	0.71 (0.028)	3.68 (0.145)	3.94 (0.155)	0.66 (0.026)	1.37 (0.054)	0.43 (0.017)	—	A7
ASMD185F	8.00 (0.315)	9.40 (0.370)	—	3.00 (0.118)	6.0 (0.24)	6.71 (0.264)	0.56 (0.022)	0.71 (0.028)	0.56 (0.022)	0.71 (0.028)	3.68 (0.145)	3.94 (0.155)	0.66 (0.026)	1.37 (0.054)	0.43 (0.017)	—	A7
ASMD200F	8.00 (0.315)	9.40 (0.370)	—	3.00 (0.118)	6.0 (0.24)	6.71 (0.264)	0.56 (0.022)	0.71 (0.028)	0.56 (0.022)	0.71 (0.028)	3.68 (0.145)	3.94 (0.155)	0.66 (0.026)	1.37 (0.054)	0.43 (0.017)	—	A7
ASMD250F	8.00 (0.315)	9.40 (0.370)	—	3.00 (0.118)	6.0 (0.24)	6.71 (0.264)	0.56 (0.022)	0.71 (0.028)	0.56 (0.022)	0.71 (0.028)	3.68 (0.145)	3.94 (0.155)	0.66 (0.026)	1.37 (0.054)	0.43 (0.017)	—	A7

Part Number	A		B		C		D		E		Figure
	Min	Max	Min	Max	Min	Max	Min	Max	Min	Max	
femtoASMD											
12-15V — Surface-mount											
femtoASMD005F	1.40 (0.055)	1.80 (0.071)	0.45 (0.017)	0.85 (0.033)	0.60 (0.023)	1.00 (0.039)	0.10 (0.004)	0.50 (0.020)	0.075 (0.003)	—	A13
femtoASMD008F	1.40 (0.055)	1.80 (0.071)	0.45 (0.017)	0.85 (0.033)	0.60 (0.023)	1.00 (0.039)	0.10 (0.004)	0.50 (0.020)	0.075 (0.003)	—	A13
femtoASMD010F/15	1.40 (0.055)	1.80 (0.071)	0.45 (0.017)	0.85 (0.033)	0.60 (0.023)	1.00 (0.039)	0.10 (0.004)	0.50 (0.020)	0.075 (0.003)	—	A13
picoASMD											
15V — Surface-mount											
picoASMD010S	2.00 (0.079)	2.20 (0.087)	0.60 (0.023)	1.00 (0.040)	1.30 (0.051)	1.50 (0.059)	0.25 (0.010)	0.75 (0.030)	0.076 (0.003)	—	A13
picoASMD012S	2.00 (0.079)	2.20 (0.087)	0.44 (0.017)	0.68 (0.027)	1.30 (0.051)	1.50 (0.059)	0.25 (0.010)	0.75 (0.030)	0.076 (0.003)	—	A13

PolySwitch Resettable Devices

Automotive Devices

Table A4 — Dimensions in Millimeters and (Inches)

(Cont'd)

Part Number	A		B		C		D		E		Figure
	Min	Max	Min	Max	Min	Max	Min	Max	Min	Max	
nanoASMD											
13.2-48V — Surface-mount											
nanoASMD010F	3.00 (0.118)	3.40 (0.134)	0.62 (0.024)	1.00 (0.039)	1.37 (0.054)	1.80 (0.071)	0.25 (0.010)	0.75 (0.030)	0.076 (0.003)	—	A13
nanoASMD012F	3.00 (0.118)	3.40 (0.134)	0.62 (0.024)	1.00 (0.039)	1.37 (0.054)	1.80 (0.071)	0.25 (0.010)	0.75 (0.030)	0.076 (0.003)	—	A13
nanoASMD016F	3.00 (0.118)	3.40 (0.134)	0.62 (0.024)	1.00 (0.039)	1.37 (0.054)	1.80 (0.071)	0.25 (0.010)	0.75 (0.030)	0.076 (0.003)	—	A13
nanoASMD020F	3.00 (0.118)	3.40 (0.134)	0.58 (0.023)	0.82 (0.032)	1.37 (0.054)	1.80 (0.071)	0.25 (0.010)	0.75 (0.030)	0.076 (0.003)	—	A13
nanoASMD025F	3.00 (0.118)	3.40 (0.134)	0.58 (0.023)	0.82 (0.032)	1.37 (0.054)	1.80 (0.071)	0.25 (0.010)	0.75 (0.030)	0.076 (0.003)	—	A13
nanoASMD035F	3.00 (0.118)	3.40 (0.134)	0.58 (0.023)	0.82 (0.032)	1.37 (0.054)	1.80 (0.071)	0.25 (0.010)	0.75 (0.030)	0.076 (0.003)	—	A13
nanoASMD050F/13.2	3.00 (0.118)	3.40 (0.134)	0.50 (0.019)	0.74 (0.029)	1.37 (0.054)	1.80 (0.071)	0.25 (0.010)	0.75 (0.030)	0.076 (0.003)	—	A13
microASMD											
13.2-30V — Surface-mount											
microASMD005F	3.0 (0.118)	3.43 (0.135)	0.50 (0.019)	0.85 (0.034)	2.35 (0.092)	2.80 (0.110)	0.25 (0.010)	0.75 (0.030)	0.076 (0.003)	—	A13
microASMD010F	3.0 (0.118)	3.43 (0.135)	0.50 (0.019)	0.85 (0.034)	2.35 (0.092)	2.80 (0.110)	0.25 (0.010)	0.75 (0.030)	0.076 (0.003)	—	A13
microASMD050F	3.0 (0.118)	3.43 (0.135)	0.38 (0.015)	0.62 (0.025)	2.35 (0.092)	2.80 (0.110)	0.25 (0.010)	0.75 (0.030)	0.076 (0.003)	—	A13
miniASMD											
12-60V — Surface-mount											
miniASMD010F	4.37 (0.172)	4.73 (0.186)	0.635 (0.025)	0.89 (0.035)	3.07 (0.121)	3.41 (0.134)	0.25 (0.010)	0.95 (0.040)	0.20 (0.008)	—	A13
miniASMD014F	4.37 (0.172)	4.73 (0.186)	0.635 (0.025)	0.89 (0.035)	3.07 (0.121)	3.41 (0.134)	0.25 (0.010)	0.95 (0.040)	0.20 (0.008)	—	A13
miniASMD020F	4.37 (0.172)	4.73 (0.186)	0.635 (0.025)	0.89 (0.035)	3.07 (0.121)	3.41 (0.134)	0.25 (0.010)	0.95 (0.040)	0.20 (0.008)	—	A13
miniASMD030F	4.37 (0.172)	4.73 (0.186)	0.635 (0.025)	0.89 (0.035)	3.07 (0.121)	3.41 (0.134)	0.25 (0.010)	0.95 (0.040)	0.20 (0.008)	—	A13
miniASMD050F	4.37 (0.172)	4.73 (0.186)	0.38 (0.015)	0.62 (0.025)	3.07 (0.121)	3.41 (0.134)	0.25 (0.010)	0.95 (0.040)	0.20 (0.008)	—	A13
miniASMD075F	4.37 (0.172)	4.73 (0.186)	0.38 (0.015)	0.62 (0.025)	3.07 (0.121)	3.41 (0.134)	0.25 (0.010)	0.95 (0.040)	0.20 (0.008)	—	A13
miniASMD075F/24	4.37 (0.172)	4.83 (0.190)	0.81 (0.032)	1.46 (0.057)	3.07 (0.121)	3.41 (0.134)	0.25 (0.010)	0.95 (0.040)	0.20 (0.008)	—	A13
miniASMD075F/33	4.37 (0.172)	4.73 (0.190)	0.94 (0.037)	1.46 (0.057)	3.07 (0.121)	3.41 (0.134)	0.25 (0.010)	0.95 (0.040)	0.20 (0.008)	—	A13
miniASMD110F/16	4.37 (0.172)	4.83 (0.190)	0.28 (0.011)	0.48 (0.019)	3.07 (0.121)	3.41 (0.134)	0.25 (0.010)	0.95 (0.040)	0.20 (0.008)	—	A13
miniASMD110F/24	4.37 (0.172)	4.83 (0.190)	0.81 (0.032)	1.46 (0.057)	3.07 (0.121)	3.41 (0.134)	0.25 (0.010)	0.95 (0.040)	0.20 (0.008)	—	A13
miniASMD125F/16	4.37 (0.172)	4.83 (0.190)	0.28 (0.011)	0.48 (0.019)	3.07 (0.121)	3.41 (0.134)	0.25 (0.010)	0.95 (0.040)	0.20 (0.008)	—	A13
miniASMD150F/12	4.37 (0.172)	4.83 (0.190)	0.28 (0.011)	0.48 (0.019)	3.07 (0.121)	3.41 (0.134)	0.25 (0.010)	0.95 (0.040)	0.20 (0.008)	—	A13
miniASMD150F/16	4.37 (0.172)	4.83 (0.190)	0.28 (0.011)	0.48 (0.019)	3.07 (0.121)	3.41 (0.134)	0.25 (0.010)	0.95 (0.040)	0.20 (0.008)	—	A13

PolySwitch Resettable Devices

Automotive Devices

Table A4 — Dimensions in Millimeters and (Inches)

(Cont'd)

Part Number	A		B		C		D		E		Figure
	Min	Max	Min	Max	Min	Max	Min	Max	Min	Max	
miniASMDC											
12-60V — Surface-mount											
miniASMDC150F/24	4.37 (0.172)	4.83 (0.190)	1.00 (0.040)	1.94 (0.077)	3.07 (0.121)	3.41 (0.134)	0.25 (0.010)	0.95 (0.040)	0.20 (0.008)	—	A13
miniASMDC200F/16	4.37 (0.172)	4.73 (0.186)	0.51 (0.020)	1.22 (0.048)	3.07 (0.121)	3.41 (0.134)	0.25 (0.010)	0.95 (0.040)	0.20 (0.008)	—	A13
miniASMDC260F/12	4.37 (0.172)	4.83 (0.190)	1.02 (0.042)	1.52 (0.060)	3.07 (0.121)	3.41 (0.134)	0.25 (0.010)	0.95 (0.040)	0.20 (0.008)	—	A13
miniASMDC260F/13.2	4.37 (0.172)	4.83 (0.190)	1.02 (0.042)	1.52 (0.060)	3.07 (0.121)	3.41 (0.134)	0.25 (0.010)	0.95 (0.040)	0.20 (0.008)	—	A13
miniASMDC260F/16	4.37 (0.172)	4.83 (0.190)	1.02 (0.042)	1.52 (0.060)	3.07 (0.121)	3.41 (0.134)	0.25 (0.010)	0.95 (0.040)	0.20 (0.008)	—	A13
ASMDC											
24-60V — Surface-mount											
ASMDC030F	7.30 (0.287)	7.70 (0.303)	0.63 (0.025)	0.90 (0.035)	4.90 (0.193)	5.30 (0.209)	0.25 (0.010)	0.95 (0.040)	0.20 (0.008)	—	A13
ASMDC050F	7.30 (0.287)	7.70 (0.303)	0.63 (0.025)	0.90 (0.035)	4.90 (0.193)	5.30 (0.209)	0.25 (0.010)	0.95 (0.040)	0.20 (0.008)	—	A13
ASMDC075F	7.30 (0.287)	7.70 (0.303)	0.63 (0.025)	0.90 (0.035)	4.90 (0.193)	5.30 (0.209)	0.25 (0.010)	0.95 (0.040)	0.20 (0.008)	—	A13
ASMDC125F/33	7.30 (0.287)	7.70 (0.303)	0.45 (0.018)	0.71 (0.028)	4.90 (0.193)	5.30 (0.209)	0.25 (0.010)	0.95 (0.040)	0.20 (0.008)	—	A13
ASMDC185F/33	7.30 (0.287)	7.70 (0.303)	0.90 (0.035)	1.20 (0.047)	4.90 (0.193)	5.30 (0.209)	0.25 (0.010)	0.95 (0.040)	0.20 (0.008)	—	A13
ASMDC300F/24	7.30 (0.287)	7.70 (0.303)	0.80 (0.031)	1.10 (0.043)	4.90 (0.193)	5.30 (0.209)	0.25 (0.010)	0.95 (0.040)	0.20 (0.008)	—	A13
nanoASMDCH											
16V — Surface-mount											
nanoASMDCH035F	3.00 (0.118)	3.40 (0.134)	0.91 (0.036)	1.14 (0.045)	1.37 (0.054)	1.80 (0.071)	0.25 (0.010)	0.75 (0.030)	0.076 (0.003)	—	A13

PolySwitch Resettable Devices

Automotive Devices

Figures A14-A25 – Typical Time-to-Trip at 25°C

AGRF

- A = AGRF400
- B = AGRF500
- C = AGRF600
- D = AGRF700
- E = AGRF800
- F = AGRF900
- G = AGRF1000
- H = AGRF1100
- I = AGRF1200
- J = AGRF1400

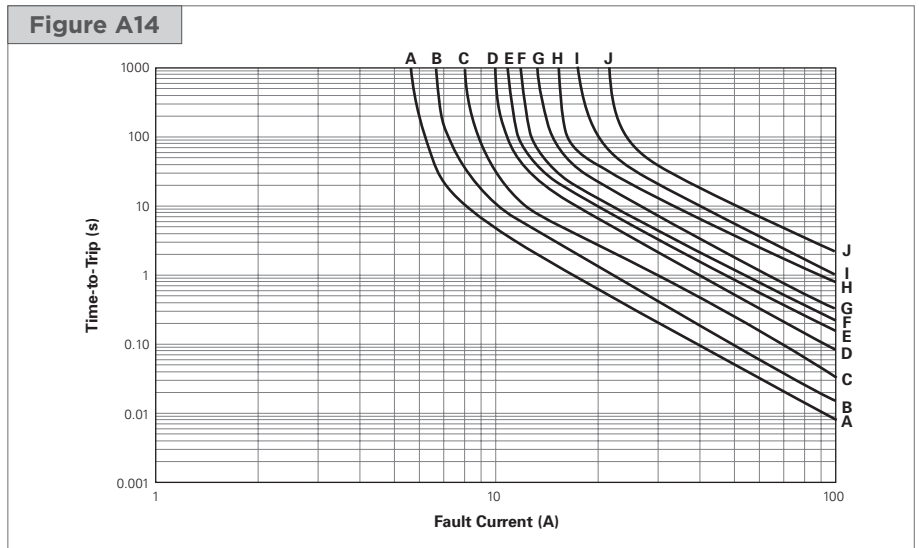

AHRF

- | | |
|-------------|--------------|
| A = AHRF050 | K = AHRF700 |
| B = AHRF070 | L = AHRF750 |
| C = AHRF100 | M = AHRF800 |
| D = AHRF200 | N = AHRF900 |
| E = AHRF300 | O = AHRF1000 |
| F = AHRF400 | P = AHRF1100 |
| G = AHRF450 | Q = AHRF1300 |
| H = AHRF550 | R = AHRF1400 |
| I = AHRF600 | S = AHRF1500 |
| J = AHRF650 | |

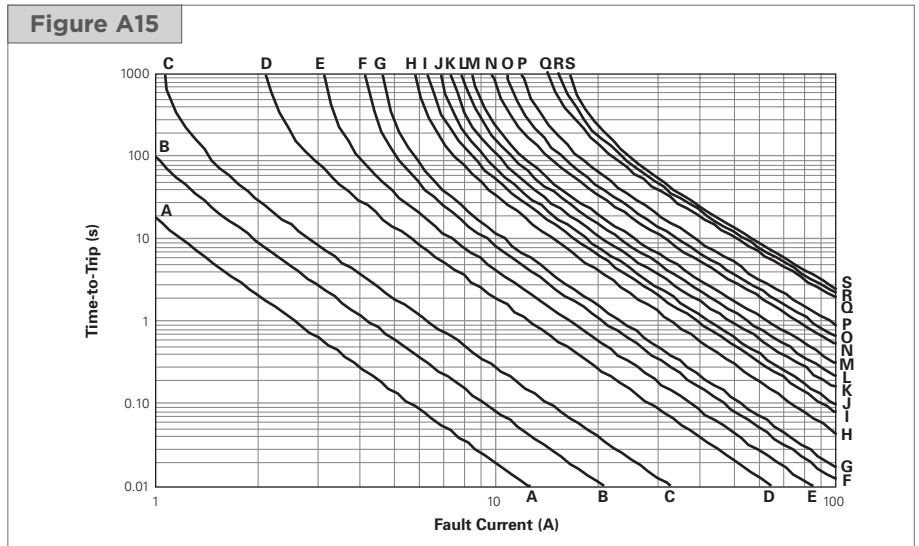

AHEF

- A = AHEF050
- B = AHEF070
- C = AHEF100
- D = AHEF300
- E = AHEF500
- F = AHEF750
- G = AHEF1000

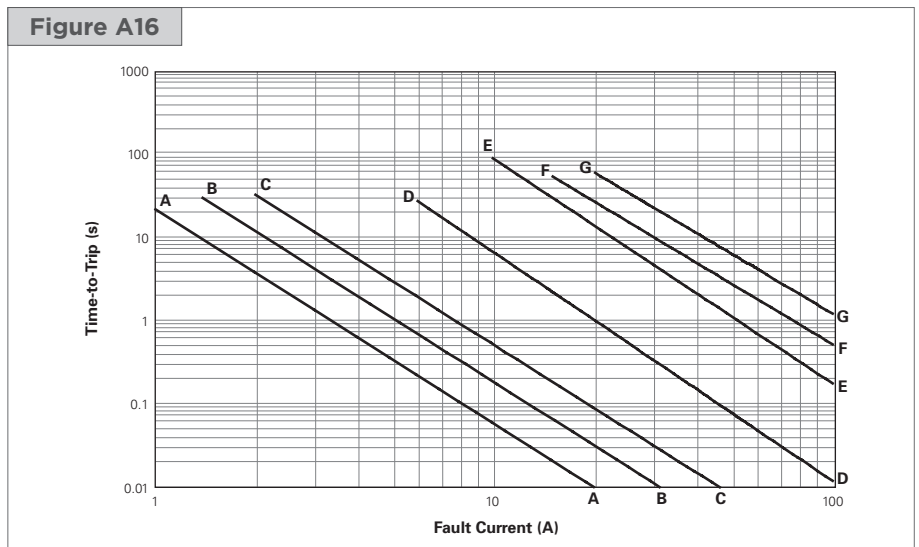

PolySwitch Resettable Devices Automotive Devices

Figures A14-A25 – Typical Time-to-Trip at 25°C

(Cont'd)

AHS

- A = AHS080-2018
- B = AHS120
- C = AHS160
- D = AHS200
- E = AHS300



ASMD

- A = ASMD030F
- B = ASMD050F
- C = ASMD075F
- D = ASMD100F
- E = ASMD125F
- F = ASMD150F, ASMD150F/33
- G = ASMD185F
- H = ASMD200F
- I = ASMD250F



femtoASMDC

- A = femtoASMDC005F
- B = femtoASMDC008F
- C = femtoASMDC010F/15



PolySwitch Resettable Devices Automotive Devices

Figures A14-A25 – Typical Time-to-Trip at 25°C

(Cont'd)

picoASMD

- A = picoASMD010S
- B = picoASMD020S



nanoASMD

- A = nanoASMD010F
- B = nanoASMD012F
- C = nanoASMD016F
- D = nanoASMD020F
- E = nanoASMD025F
- F = nanoASMD035F
- G = nanoASMD050F/13.2



microASMD

- A = microASMD005F
- B = microASMD010F
- C = microASMD050F



PolySwitch Resettable Devices

Automotive Devices

Figures A14-A25 – Typical Time-to-Trip at 25°C

(Cont'd)

miniASMDC

- A = miniASMDC010F, miniASMDC014F
- B = miniASMDC020F
- C = miniASMDC030F
- D = miniASMDC050F
- E = miniASMDC075F
- F = miniASMDC075F/24
- G = miniASMDC075F/33
- H = miniASMDC110F/16
- I = miniASMDC110F/24
- J = miniASMDC125F/16
- K = miniASMDC150F/12
- L = miniASMDC150F/16
- M = miniASMDC150F/24
- N = miniASMDC200F/16
- O = miniASMDC260F/12, miniASMDC260F/13.2,
miniASMDC260F/16

Figure A23



ASMDC

- A = ASMDC030F
- B = ASMDC050F
- C = ASMDC075F
- D = ASMDC125F/33
- E = ASMDC185F/33
- F = ASMDC300F/24

Figure A24



nanoASMDCH

- A = nanoASMDCH035F

Figure A25



PolySwitch Resettable Devices

Automotive Devices

Table A5 — Physical Characteristics and Environmental Specifications

AGRF	
Physical Characteristics	
Lead Material	AGRF400 to AGRF1100 : Tin-plated Copper, 0.52mm ² (20AWG) \varnothing 0.8 mm/0.032in
	AGRF1200 to AGRF1400 : Tin-plated Copper, 0.82mm ² (18AWG) \varnothing 1.0mm/0.040in
Soldering Characteristics	Solderability per ANSI/J-STD-002 Category 3
Solder Heat Withstand	AGRF400 : per IEC68-2-20 Test Tb, Method 1A, Condition A: Can Withstand 5 s at 260°C \pm 5°C
	AGRF500-AGRF1400 : per IEC68-2-20 Test Tb, Method 1A, Condition B: Can Withstand 10 s at 260°C \pm 5°C
Insulating Material	Cured, Flame-retardant Epoxy Polymer; Meets UL 94V-0
Operation Temperature	-40°C~85°C

Note: See PS400 for other physical characteristics.
Devices are not intended to be placed through a reflow process.

Environmental Specifications		
Test	Conditions	Resistance Change
Passive Aging	70°C, 1000 hrs	\pm 5%
	85°C, 1000 hrs	\pm 5%
Humidity Aging	85°C, 85% RH, 1000 hrs	\pm 5%
Thermal Shock	85°C, -40°C (10 Times)	\pm 5%
Solvent Resistance	MIL-STD-202, Method 215F	No Change

Note: See PS400 for other environmental specifications.

AHRF	
Physical Characteristics	
Lead material	AHRF050 to AHRF200 : Tin-plated Copper-clad Steel, 0.205mm ² (24 AWG), \varnothing 0.51mm/0.020in
	AHRF300 to AHRF1100 : Tin-plated Copper 0.52mm ² (20 AWG), \varnothing 0.81mm/0.032in
	AHRF1300 to AHRF1500 : Tin-plated Copper 0.82mm ² (18 AWG), \varnothing 1.0mm/0.04in
Soldering Characteristics	Solderability per ANSI/J-STD 002 Category 3
Solder Heat Withstand	Per IEC 68-2-20, Test Tb, Method 1A, Condition B; Can Withstand 10 s at 260°C \pm 5°C
Insulating Material	Cured, Flame-retardant Epoxy Polymer; Meets UL 94V-0 Requirements
Operation Temperature	-40°C~125°C

Note: See PS400 for other physical characteristics.
Devices are not intended to be placed through a reflow process.

Environmental Specifications		
Test	Conditions	Resistance Change
Passive Aging	70°C, 1000 hrs	\pm 5%
	85°C, 1000 hrs	\pm 5%
Humidity Aging	85°C, 85% RH, 1000 hrs	\pm 5%
Thermal Shock	125°C, -40°C (10 Times)	\pm 5%
Solvent Resistance	MIL-STD-202, Method 215F	No Change

Note: See PS400 for other environmental specifications.

PolySwitch Resettable Devices

Automotive Devices

Table A5 — Physical Characteristics and Environmental Specifications

(Cont'd)

AHEF	
Physical Characteristics	
Lead Material	AHEF050 to AHEF100: Tin-plated Copper-clad Steel, 0.205mm ² (24 AWG), ø 0.51mm/0.020in. AHEF300 to AHEF750: Tin-plated Copper 0.52mm ² (20 AWG), ø 0.81mm/0.032in. AHEF1000: Tin-plated Copper 0.82mm ² (18 AWG), ø 1.0mm/0.04in
Soldering Characteristics	Solderability per ANSI/J-STD 002 Category 3
Solder Heat Withstand	Per IEC 68-2-20, Test Tb, Method 1A, Condition B; Can Withstand 10 s at 260°C ± 5°C
Insulating Material	Cured, Flame-retardant Epoxy Polymer; Meets UL 94V-0 Requirements
Operation Temperature	-40°C~125°C

Note: See PS400 for other physical characteristics.
Devices are not intended to be placed through a reflow process.

Environmental Specifications		
Test	Conditions	Resistance Change
Passive Aging	70°C, 1000 hrs	±5%
	85°C, 1000 hrs	±5%
Humidity Aging	85°C, 85% RH, 1000 hrs	±5%
Thermal Shock	125°C, -40°C (10 Times)	±5%
Solvent Resistance	MIL-STD-202, Method 215F	No Change

Note: See PS400 for other environmental specifications.

AHS	
Physical Characteristics	
Lead Material	Tin-plated Brass to MIL-T-10727B
Soldering Characteristics	Solderability per ANSI-J-STD-002 Category 1
Solder Heat Withstand	Per IEC-STD 68-2-20, Test Tb, Section 5, Method 1A
Flammability	Per IEC 695-2-2 Needle Flame Test for 20 s
Operation Temperature	-40°C~125°C

Note: See PS400 for other physical characteristics.

Environmental Specifications		
Test	Conditions	Resistance Change
Passive Aging	70°C, 1000 hrs	±3% Typical
	85°C, 1000 hrs	±5% Typical
Humidity Aging	85°C, 85% RH, 1000 hrs	±1.2% Typical
Thermal Shock	125°C, -40°C (20 Times)	-33% Typical
Solvent Resistance	Freon	No Change
	Trichloroethane	No Change
	Hydrocarbons	No Change

Note: See PS400 for other environmental specifications.

PolySwitch Resettable Devices

Automotive Devices

Table A5 — Physical Characteristics and Environmental Specifications

(Cont'd)

ASMD

Physical Characteristics	
Terminal Pad Material	98%+ Tin-plated Brass
Soldering Characteristics	Solderability per ANSI-J-STD-002 Category 1
Solder Heat Withstand	Per IEC-STD 68-2-20, Test Tb, Section 5, Method 1A
Flammability Resistance	Per IEC 695-2-2 Needle Flame Test for 20 s
Recommended Storage Conditions	40°C max, 70% RH max; Devices May Not Meet Specified Ratings if Storage Conditions are Exceeded
Operation Temperature	-40°C~85°C

Note: See PS400 for other environmental specifications.

Environmental Specifications

Test	Conditions	Resistance Change
Passive Aging	60°C, 1000 hrs	±3% Typical
	85°C, 1000 hrs	±5% Typical
Humidity Aging	85°C, 85% RH, 100 hrs	±1.2% Typical
Thermal Shock	85°C, -40°C (20 Times)	-33% Typical
	125°C, -55°C (10 Times)	-33% Typical
Solvent Resistance	Freon	No Change
	Trichloroethane	No Change
	Hydrocarbons	No Change

Note: See PS400 for other environmental specifications.

femtoASMD/picoASMD/nanoASMD/microASMD/miniASMD/ASMD

Physical Characteristics	
Terminal Pad Material	100% Matte Tin with Nickel Underplate
Soldering Characteristics	Solderability per ANSI-J-STD-002 Category 3
Solder Heat Withstand	Per IEC-STD 68-2-20, Test Tb, Section 5, Method 1A
Flammability Resistance	Per IEC 695-2-2 Needle Flame Test for 20 s
Recommended Storage Conditions	40°C max, 70% RH max; Devices May Not Meet Specified Ratings if Storage Conditions are Exceeded
Operation Temperature	-40°C~85°C

Note: See PS400 for other physical characteristics.

Environmental Specifications

Test	Conditions	Resistance Change
Passive Aging	60°C, 1000 hrs	±3% Typical
	85°C, 1000 hrs	±5% Typical
Humidity Aging	85°C, 85% RH, 100 hrs	±1.2% Typical
Thermal Shock	85°C, -40°C (20 Times)	-33% Typical
	125°C, -55°C (10 Times)	-33% Typical
Solvent Resistance	Freon	No Change
	Trichloroethane	No Change
	Hydrocarbons	No Change

Note: See PS400 for other environmental specifications.

PolySwitch Resettable Devices

Automotive Devices

Table A5 — Physical Characteristics and Environmental Specifications

(Cont'd)

nanoASMDCH		
Physical Characteristics		
Terminal Pad Material	100% matte tin with nickel underplate	
Soldering Characteristics	Solderability per ANSI-J-STD-002 Category 3	
Solder Heat Withstand	per IEC-STD 68-2-20, Test Tb, Section 5, Method 1A	
Flammability Resistance	per IEC 695-2-2 Needle Flame Test for 20 s	
Recommended Storage Conditions	40°C max, 70% RH max; Devices May Not Meet Specified Ratings if Storage Conditions are Exceeded	
Operation Temperature	-40°C~125°C	
Note: See PS400 for other environmental specifications.		
Environmental Specifications		
Test	Conditions	Resistance Change
Passive Aging	60°C, 1000 hrs	±3% Typical
	85°C, 1000 hrs	±5% Typical
Humidity Aging	85°C, 85% RH, 100 hrs	±1.2% Typical
Thermal Shock	125°C, -40°C (10 Times)	-33% Typical
Solvent Resistance	Freon	No Change
	Trichloroethane	No Change
	Hydrocarbons	No Change
Note: See PS400 for other environmental specifications.		

PolySwitch Resettable Devices

Automotive Devices

Table A6 — Packaging and Marking Information

Part Number	Bag Quantity	Tape and Reel Quantity	Ammo Pack Quantity	Standard Package Quantity	Part Marking	Agency Recognition
AGRF						
Radial-leaded						
AGRF400	500	—	—	10,000	G4	*
AGRF400-2	—	2,500	—	12,500	G4	*
AGRF400-AP	—	—	2,000	10,000	G4	*
AGRF500	500	—	—	10,000	G5	*
AGRF500-2	—	2,000	—	10,000	G5	*
AGRF500-AP	—	—	2,000	10,000	G5	*
AGRF600	500	—	—	10,000	G6	*
AGRF600-2	—	2,000	—	10,000	G6	*
AGRF600-AP	—	—	2,000	10,000	G6	*
AGRF700	500	—	—	10,000	G7	*
AGRF700-2	—	1,500	—	7,500	G7	*
AGRF700-AP	—	—	1,500	7,500	G7	*
AGRF800	500	—	—	10,000	G8	*
AGRF800-2	—	1,500	—	7,500	G8	*
AGRF800-AP	—	—	1,500	7,500	G8	*
AGRF900	500	—	—	10,000	G9	*
AGRF900-2	—	1,000	—	5,000	G9	*
AGRF900-AP	—	—	1,000	5,000	G9	*
AGRF1000	250	—	—	5,000	G10	*
AGRF1000-2	—	1,000	—	5,000	G10	*
AGRF1000-AP	—	—	1,000	5,000	G10	*
AGRF1100	250	—	—	5,000	G11	*
AGRF1100-2	—	1,000	—	5,000	G11	*
AGRF1100-AP	—	—	1,000	5,000	G11	*
AGRF1200	250	—	—	5,000	G12	*
AGRF1200-2	—	1,000	—	5,000	G12	*
AGRF1200-AP	—	—	1,000	5,000	G12	*
AGRF1400	250	—	—	5,000	G14	*
AGRF1400-2	—	1,000	—	5,000	G14	*
AGRF1400-AP	—	—	1,000	5,000	G14	*
AHRF (High Temperature)						
Radial-leaded						
AHRF050	500	—	—	10,000	H0.5	*
AHRF050-2	—	2,500	—	12,500	H0.5	*
AHRF050-AP	—	—	2,500	12,500	H0.5	*
AHRF070	500	—	—	10,000	H0.7	*
AHRF070-2	—	2,500	—	12,500	H0.7	*
AHRF070-AP	—	—	2,500	12,500	H0.7	*
AHRF100	500	—	—	10,000	H1	*
AHRF100-2	—	2,500	—	12,500	H1	*
AHRF100-AP	—	—	2,500	12,500	H1	*
AHRF200	500	—	—	10,000	H2	*
AHRF200-2	—	2,500	—	12,500	H2	*
AHRF200-AP	—	—	2,500	12,500	H2	*
AHRF300	500	—	—	10,000	H3	*
AHRF300-2	—	2,000	—	10,000	H3	*
AHRF300-AP	—	—	2,000	10,000	H3	*
AHRF400	500	—	—	10,000	H4	*
AHRF400-2	—	1,500	—	7,500	H4	*
AHRF400-AP	—	—	1,500	7,500	H4	*

* These devices are intended for use in automotive applications.

For commercial alternatives to these products please refer to radial-leaded devices or surface-mount devices product brochures.

PolySwitch Resettable Devices

Automotive Devices

Table A6 — Packaging and Marking Information

(Cont'd)

Part Number	Bag Quantity	Tape and Reel Quantity	Ammo Pack Quantity	Standard Package Quantity	Part Marking	Agency Recognition
AHRF (High Temperature)						
Radial-leaded						
AHRF450	500	—	—	10,000	H4.5	*
AHRF450-2	—	1,500	—	7,500	H4.5	*
AHRF450-AP	—	—	1,500	7,500	H4.5	*
AHRF550	500	—	—	10,000	H5.5	*
AHRF550-2	—	2,000	—	10,000	H5.5	*
AHRF550-AP	—	—	2,000	10,000	H5.5	*
AHRF600	500	—	—	10,000	H6	*
AHRF600-2	—	2,000	—	10,000	H6	*
AHRF600-AP	—	—	2,000	10,000	H6	*
AHRF650	500	—	—	10,000	H6.5	*
AHRF650-2	—	1,500	—	7,500	H6.5	*
AHRF650-AP	—	—	1,500	7,500	H6.5	*
AHRF700	500	—	—	10,000	H7	*
AHRF700-2	—	1,500	—	7,500	H7	*
AHRF700-AP	—	—	1,500	7,500	H7	*
AHRF750	500	—	—	10,000	H7.5	*
AHRF750-2	—	1,000	—	5,000	H7.5	*
AHRF750-AP	—	—	1,000	5,000	H7.5	*
AHRF800	500	—	—	10,000	H8	*
AHRF800-2	—	1,000	—	5,000	H8	*
AHRF800-AP	—	—	1,000	5,000	H8	*
AHRF900	250	—	—	5,000	H9	*
AHRF900-2	—	1,000	—	5,000	H9	*
AHRF900-AP	—	—	1,000	5,000	H9	*
AHRF1000	250	—	—	5,000	H10	*
AHRF1000-2	—	1,000	—	5,000	H10	*
AHRF1000-AP	—	—	1,000	5,000	H10	*
AHRF1100	250	—	—	5,000	H11	*
AHRF1100-2	—	1,000	—	5,000	H11	*
AHRF1100-AP	—	—	1,000	5,000	H11	*
AHRF1300	250	—	—	5,000	H13	*
AHRF1300-2	—	1,000	—	5,000	H13	*
AHRF1300-AP	—	—	1,000	5,000	H13	*
AHRF1400	250	—	—	5,000	H14	*
AHRF1400-2	—	1,000	—	5,000	H14	*
AHRF1400-AP	—	—	1,000	5,000	H14	*
AHRF1500	250	—	—	5,000	H15	*
AHRF1500-2	—	1,000	—	5,000	H15	*
AHRF1500-AP	—	—	1,000	5,000	H15	*
AHEF (High Temperature)						
Radial-leaded						
AHEF050	500	—	—	10,000	E0.5	*
AHEF070	500	—	—	10,000	E0.7	*
AHEF100	500	—	—	10,000	E1	*
AHEF300	500	—	—	10,000	E3	*
AHEF500	250	—	—	5,000	E5	*
AHEF750	250	—	—	5,000	E7.5	*
AHEF1000	250	—	—	5,000	E10	*

* These devices are intended for use in automotive applications.

For commercial alternatives to these products please refer to the radial-leaded devices or surface-mount devices product brochures.

PolySwitch Resettable Devices

Automotive Devices

Table A6 — Packaging and Marking Information

(Cont'd)

Part Number	Tape and Reel Quantity	Standard Package Quantity	Part Marking	Recommended Pad Layouts [mm(in) See Figure A26]			Agency Recognition
				Dimension A (Min*/Nom)	Dimension B (Nom)	Dimension C (Nom)	
AHS (High Temperature)							
Surface-mount							
AHS080-2018	4,000	20,000	H08	4.6 (0.18)	1.5 (0.06)	3.4 (0.134)	*
AHS120	2,000	10,000	H12	3.1 (0.12)	2.3 (0.09)	5.1 (0.201)	*
AHS160	1,500	7,500	160	4.6 (0.18)	2.3 (0.09)	6.1 (0.240)	*
AHS200	1,500	7,500	H200	4.6 (0.18)	2.3 (0.09)	6.1 (0.240)	*
AHS300	1,500	7,500	H300	4.6 (0.18)	2.3 (0.09)	6.1 (0.240)	*
ASMD							
Surface-mount							
ASMD030F	2,000	10,000	030F	3.1 (0.12)	2.3 (0.09)	5.1 (0.201)	*
ASMD050F	2,000	10,000	050F	3.1 (0.12)	2.3 (0.09)	5.1 (0.201)	*
ASMD075F	2,000	10,000	075F	3.1 (0.12)	2.3 (0.09)	5.1 (0.201)	*
ASMD100F	2,000	10,000	100F	3.1 (0.12)	2.3 (0.09)	5.1 (0.201)	*
ASMD125F	2,000	10,000	125F	3.1 (0.12)	2.3 (0.09)	5.1 (0.201)	*
ASMD150F	1,500	7,500	150F	4.6 (0.18)	2.3 (0.09)	6.1 (0.240)	*
ASMD150F/33	1,500	7,500	153F	4.6 (0.18)	2.3 (0.09)	6.1 (0.240)	*
ASMD185F	1,500	7,500	185A	4.6 (0.18)	2.3 (0.09)	6.1 (0.240)	*
ASMD200F	1,500	7,500	200F	4.6 (0.18)	2.3 (0.09)	6.1 (0.240)	*
ASMD250F	1,500	7,500	250F	4.6 (0.18)	2.3 (0.09)	6.1 (0.240)	*
femtoASMD							
Surface-mount							
femtoASMD005F	4,000	20,000	A	0.80 (0.032)	0.60 (0.024)	0.80 (0.032)	*
femtoASMD008F	4,000	20,000	T	0.80 (0.032)	0.60 (0.024)	0.80 (0.032)	*
femtoASMD010F/15	4,000	20,000	B	0.80 (0.032)	0.60 (0.024)	0.80 (0.032)	*
picoASMD							
Surface-mount							
picoASMD010S	3,000	15,000	C	1.50 (0.060)	1.00 (0.039)	1.20 (0.047)	*
picoASMD012S	4,000	20,000	F	1.50 (0.060)	1.00 (0.039)	1.20 (0.047)	*
nanoASMD							
Surface-mount							
nanoASMD010F	3,000	15,000	A	1.60 (0.063)	1.00 (0.039)	2.00 (0.079)	*
nanoASMD012F	3,000	15,000	P	1.60 (0.063)	1.00 (0.039)	2.00 (0.079)	*
nanoASMD016F	3,000	15,000	N	1.60 (0.063)	1.00 (0.039)	2.00 (0.079)	*
nanoASMD020F	3,000	15,000	02	1.60 (0.063)	1.00 (0.039)	2.00 (0.079)	*
nanoASMD025F	3,000	15,000	C	1.60 (0.063)	1.00 (0.039)	2.00 (0.079)	*
nanoASMD035F	3,000	15,000	03	1.60 (0.063)	1.00 (0.039)	2.00 (0.079)	*
nanoASMD050F/13.2	3,000	15,000	M	1.60 (0.063)	1.00 (0.039)	2.00 (0.079)	*
microASMD							
Surface-mount							
microASMD005F	4,000	20,000	05	2.50 (0.098)	1.00 (0.039)	2.00 (0.079)	*
microASMD010F	4,000	20,000	10	2.50 (0.098)	1.00 (0.039)	2.00 (0.079)	*
microASMD050F	4,000	20,000	50	2.50 (0.098)	1.00 (0.039)	2.00 (0.079)	*
miniASMD							
Surface-mount							
miniASMD010F	2,000	10,000	10	3.15 (0.124)	1.68 (0.066)	3.10 (0.122)	*
miniASMD014F	2,000	10,000	14	3.15 (0.124)	1.68 (0.066)	3.10 (0.122)	*
miniASMD020F	2,000	10,000	2	3.15 (0.124)	1.68 (0.066)	3.10 (0.122)	*
miniASMD030F	2,000	10,000	3	3.15 (0.124)	1.68 (0.066)	3.10 (0.122)	*
miniASMD050F	2,000	10,000	5	3.15 (0.124)	1.68 (0.066)	3.10 (0.122)	*
miniASMD075F	2,000	10,000	7	3.15 (0.124)	1.68 (0.066)	3.10 (0.122)	*

* These devices are intended for use in automotive applications.
For commercial alternatives to these products please refer to the radial-headed devices or surface-mount devices product brochures.

PolySwitch Resettable Devices

Automotive Devices

Table A6 — Packaging and Marking Information

(Cont'd)

Part Number	Tape and Reel Quantity	Standard Package Quantity	Part Marking	Recommended Pad Layouts [mm(in) See Figure A26]			Agency Recognition
				Dimension A (Min*/Nom)	Dimension B (Nom)	Dimension C (Nom)	
miniASMDC							
Surface-mount							
miniASMDC075F/24	1,500	7,500	075F 24V	3.15 (0.124)	1.68 (0.066)	3.10 (0.122)	*
miniASMDC075F/33	1,500	7,500	075F 33V	3.15 (0.124)	1.68 (0.066)	3.10 (0.122)	*
miniASMDC110F/16	2,000	10,000	110F 16V	3.15 (0.124)	1.68 (0.066)	3.10 (0.122)	*
miniASMDC110F/24	1,500	7,500	110F 24V	3.15 (0.124)	1.68 (0.066)	3.10 (0.122)	*
miniASMDC125F/16	2,000	10,000	125F 16V	3.15 (0.124)	1.68 (0.066)	3.10 (0.122)	*
miniASMDC150F/12	2,000	10,000	150F 12V	3.15 (0.124)	1.68 (0.066)	3.10 (0.122)	*
miniASMDC150F/16	2,000	10,000	150 16V	3.15 (0.124)	1.68 (0.066)	3.10 (0.122)	*
miniASMDC150F/24	1,000	5,000	150F 24V	3.15 (0.124)	1.68 (0.066)	3.10 (0.122)	*
miniASMDC200F/16	2,000	10,000	200F 16V	3.15 (0.124)	1.68 (0.066)	3.10 (0.122)	*
miniASMDC260F/12	1,500	7,500	260F 12V	3.15 (0.124)	1.68 (0.066)	3.10 (0.122)	*
miniASMDC260F/13.2	1,500	7,500	260F 13V	3.15 (0.124)	1.68 (0.066)	3.10 (0.122)	*
miniASMDC260F/16	1,500	7,500	260F 16V	3.15 (0.124)	1.68 (0.066)	3.10 (0.122)	*
ASMDC							
Surface-mount							
ASMDC030F	4,000	20,000	030F	5.30 (0.209)	2.00 (0.079)	4.60 (0.18)	*
ASMDC050F	4,000	20,000	050F	5.30 (0.209)	2.00 (0.079)	4.60 (0.18)	*
ASMDC075F	4,000	20,000	075F	5.30 (0.209)	2.00 (0.079)	4.60 (0.18)	*
ASMDC125F/33	4,000	20,000	125F	5.30 (0.209)	2.00 (0.079)	4.60 (0.18)	*
ASMDC185F/33	4,000	20,000	185F 33V	5.30 (0.209)	2.00 (0.079)	4.60 (0.18)	*
ASMDC300F/24	4,000	20,000	300F 24V	5.30 (0.209)	2.00 (0.079)	4.60 (0.18)	*
nanoASMDC							
Surface-mount							
nanoASMDC035F	3,000	15,000	H35	1.60 (0.063)	1.00 (0.039)	2.00 (0.079)	*

* These devices are intended for use in automotive applications.
For commercial alternatives to these products please refer to the radial-leaded devices or surface-mount devices product brochures.

Figure A26 — Recommended Pad Layout



PolySwitch Resettable Devices

Automotive Devices

Table A7 — Tape and Reel Specifications for AGRF/AHRF/AHEF Automotive Devices

AGRF, AHRF and AHEF devices are available in tape and reel packaging per EIA468-B/IEC286-2 and EIA 481-2 standards. See Figures A27 and A28 for details

Description	EIA Mark	Dimension (mm)	Tolerance
Carrier Tape Width	W	18.0	-0.5/+1.0
Hold Down Tape Width	W ₄	11.0	Minimum
Top Distance between Tape Edges	W ₆	3.0	Maximum
Sprocket Hole Position	W ₅	9.0	-0.5/+0.75
Sprocket Hole Diameter	D ₀	4.0	±0.2
Abscissa to Plane (Straight Lead) (AHEF300 to AHEF1000)	H	20.3	±0.5
Abscissa to Plane (Kinked Lead) (AGRF400 to AGRF1400, AHRF050 to AHRF1500, AHEF050 to AHEF100)	H ₀	16.0	±0.5
Abscissa to Top (AGRF400 to AGRF600, AHRF050 to AHRF450, AHEF050 to AHEF300)	H ₁	32.2	Maximum
Abscissa to Top (AGRF700 to AGRF1400, AHRF550 to AHRF1500*, AHEF500 to AHEF1000)	H ₁	45.0	Maximum
Overall Width with Lead Protrusion (AGRF400 to AGRF600 & AHRF050 to AHRF450, AHEF050 to AHEF300)	C ₁	43.2	Maximum
Overall Width with Lead Protrusion (AGRF700 to AGRF1400, AHRF550 to AHRF1500, AHEF500 to AHEF1000)	C ₁	55.0	Maximum
Overall Width without Lead Protrusion (AGRF400 to AGRF600, AHRF050 to AHRF450, AHEF050 to AHEF300)	C ₂	42.5	Maximum
Overall Width without Lead Protrusion (AGRF700 to AGRF1400, AHRF550 to AHRF1500, AHEF500 to AHEF1000)	C ₂	54.0	Maximum
Lead Protrusion	L ₁	1.0	Maximum
Protrusion of Cut-out	L	11.0	Maximum
Protrusion Beyond Hold-Down Tape	l ₂	Not specified	—
Sprocket Hole Pitch	P ₀	12.7	± 0.3
Device Pitch (AGRF400 to AGRF700, AHRF050 to AHRF600, AHEF050 to AHEF300)	—	12.7	± 0.3
Device Pitch (AGRF800 to AGRF1400, AHRF650 to AHRF1500, AHEF500 to AHEF1000)	—	25.4	± 0.6
Pitch Tolerance	—	20 consec.	± 0.1
Tape Thickness	t	0.9	Maximum
Overall Tape and Lead Thickness (AGRF400 to AGRF1100, AHRF050 to AHRF1100*, AHEF050 to AHEF750)	t ₁	2.0	Maximum
Overall Tape and Lead Thickness (AGRF1200 to AGRF1400, AHRF1300 to AHRF1500*, AHEF1000)	t ₁	2.3	Maximum
Splice Sprocket Hole Alignment	—	0	± 0.3
Body Lateral Deviation	Dh	0	± 1.0
Body Tape Plane Deviation	Dp	0	± 1.3
Ordinate to Adjacent Component Lead (AGRF400 to AGRF1100, AHRF050 to AHRF900, AHEF050 to AHEF500)	P ₁	3.81	± 0.7
Ordinate to Adjacent Component Lead (AGRF1200 to AGRF1400, AHRF1000 to AHRF1500, AHEF750 to AHEF1000)	P ₁	7.62	± 0.7
Lead Spacing (AGRF400 to AGRF1100, AHRF050 to AHRF900*, AHEF050 to AHEF500)	F	5.05	± 0.75
Lead Spacing (AGRF1200 to AGRF1400, AHRF1000 to AHRF1500*, AHEF750 to AHEF1000)	F	10.15	± 0.75
Reel Width (AGRF400 to AGRF600 & AHRF050 to AHRF450, AHEF050 to AHEF300)	w ₂	56.0	Maximum
Reel Width (AGRF700 to AGRF1400, AHRF550 to AHRF1500*, AHEF500 to AHEF1000)	w ₂	63.5	Maximum
Reel Diameter	a	370.0	Maximum
Space between Flanges* (AHEF050 to AHEF300)	w ₁	48.0	Maximum
Space between Flanges* (AHEF500 to AHEF1000)	w ₁	55.0	Maximum
Arbor Hold Diameter	c	26.0	±12.0
Core Diameter*	n	91.0	Maximum
Box	—	64/372/362	Maximum
Consecutive Missing Places	—	None	—
Empty Places per Reel	—	0.1%	Maximum

* Differs from EIA specification.

PolySwitch Resettable Devices

Automotive Devices

Figure A27 — EIA Referenced Taped Component Dimensions for AGRF/AHRF/AHEF PolySwitch Automotive Devices



Figure A28 — EIA Referenced Reel Dimensions for AGRF/AHRF/AHEF PolySwitch Automotive Devices



PolySwitch Resettable Devices

Automotive Devices

Table A8 – Tape and Reel Specifications for AHS/ASMD/femtoASMDC/picoASMDC/nanoASMDC/microASMD/miniASMDC/ASMDC/nanoASMDCH PolySwitch Automotive Devices (in Millimeters)

Description	femtoASMDC EIA 481-1	picoASMDC EIA 481-1	nanoASMDC/ nanoASMDCH EIA 481-1	microASMD EIA 481-1	miniASMDC EIA 481-1	ASMDC EIA 481-1	AHS080-2018 EIA 481-2	AHS120 ASMD030F~ ASMD125F EIA 481-2	AHS160~AHS300 ASMD150F~ ASMD250F EIA 481-2
W	8.0 ± 0.30	8.0 ± 0.30	8.0 ± 0.30	8.0 ± 0.30	12.0 ± 0.30	16.0 ± 0.30	16.0 ± 0.30	16.0 ± 0.30	16.0 ± 0.30
P ₀	4.0 ± 0.10	4.0 ± 0.10	4.0 ± 0.10	4.0 ± 0.10	4.0 ± 0.10	4.0 ± 0.10	4.0 ± 0.10	4.0 ± 0.10	4.0 ± 0.10
P ₁	4.0 ± 0.10	4.0 ± 0.10	4.0 ± 0.10	4.0 ± 0.10	8.0 ± 0.10	8.0 ± 0.10	8.0 ± 0.10	8.0 ± 0.10	12.0 ± 0.10
P ₂	2.0 ± 0.05	2.0 ± 0.10	2.0 ± 0.05	2.0 ± 0.05	2.0 ± 0.05	2.0 ± 0.10	2.0 ± 0.10	2.0 ± 0.10	2.0 ± 0.10
A ₀	0.95 ± 0.05	1.70 ± 0.1	1.95 ± 0.10	2.9 ± 0.10	Table A9	Table A9	5.11 ± 0.15	5.6 ± 0.23	6.9 ± 0.23
B ₀	1.85 ± 0.05	2.45 ± 0.1	Table A9	3.50 ± 0.10	Table A9	Table A9	5.6 ± 0.23	8.1 ± 0.15	9.6 ± 0.15
B ₁ max	4.35	4.35	4.35	4.35	6.15	12.1	12.1	12.1	12.1
D ₀	1.55 ± .05	1.55 ± .05	1.55 ± .05	1.55 ± .05	1.5 + 0.10/-.00	1.5 + 0.10/-.00	1.5 + 0.10/-.00	1.5 + 0.10/-.00	1.5 + 0.10/-.00
F	3.50 ± 0.05	3.50 ± 0.05	3.50 ± 0.05	3.50 ± 0.05	5.50 ± 0.05	7.50 ± 0.10	7.50 ± 0.10	7.50 ± 0.10	7.50 ± 0.10
E ₁	1.75 ± 0.10	1.75 ± 0.10	1.75 ± 0.10	1.75 ± 0.10	1.75 ± 0.10	1.75 ± 0.10	1.75 ± 0.10	1.75 ± 0.10	1.75 ± 0.10
E ₂ min	6.25	6.25	6.25	6.25	10.25	14.25	14.25	14.25	14.25
T max	0.3	0.3	0.3	0.3	0.35	0.35	0.4	0.4	0.4
T ₁ max	0.1	0.1	0.1	0.1	0.1	0.1	0.1	0.1	0.1
K ₀	0.90 ± 0.1	Table A9	Table A9	0.9 ± 0.1	Table A9	Table A9	1.8 ± 0.15	3.2 ± 0.15	3.4 ± 0.15

Table A9 – Tape and Reel Specifications for picoASMDC/nanoASMDC/miniASMDC/ASMDC/nanoASMDCH PolySwitch Automotive Devices (in Millimeters)

Description	picoASMDC010S	picoASMDC012S	nanoASMDC010F nanoASMDC012F nanoASMDC016F nanoASMDCH035F	nanoASMDC020F nanoASMDC025F nanoASMDC035F nanoASMDC050F/13.2	
A ₀	1.70 ± 0.1	1.70 ± 0.1	1.95 ± 0.1	1.95 ± 0.1	
B ₀	2.45 ± 0.1	2.45 ± 0.1	3.5 ± 0.1	3.50 +0.1/-0.08	
K ₀	1.12 ± 0.1	0.86 ± 0.1	1.27 ± 0.1	0.89 ± 0.1	
Description	miniASMDC010F-075F miniASMDC110F/16 miniASMDC125F/16 miniASMDC150F/12 miniASMDC150F/16 miniASMDC200F/16	miniASMDC075F/24 miniASMDC075F/33 miniASMDC110F/24 miniASMDC260F/12 miniASMDC260F/13.2 miniASMDC260F/16	miniASMDC150F/24	ASMDC030F ASMDC050F ASMDC075F ASMDC125F/33	ASMDC185F/33 ASMDC300F/24
A ₀	3.5 ± 0.1	3.7 ± 0.1	3.7 ± 0.1	5.5 ± 0.1	5.35 ± 0.1
B ₀	4.95 ± 0.1	4.9 ± 0.1	4.9 ± 0.1	7.9 ± 0.1	7.85 ± 0.1
K ₀	0.9 ± 0.1	1.4 ± 0.1	1.78 ± 0.1	0.9 ± 0.1	1.45 ± 0.1

Table A10 – Reel Dimensions for AHS/ASMD/femtoASMDC/picoASMDC/nanoASMDC/microASMD/miniASMDC/ASMDC/nanoASMDCH PolySwitch Automotive Devices (in Millimeters)

Description	femtoASMDC, picoASMDC nanoASMDC, microASMD nanoASMDCH	miniASMDC	ASMDC AHS ASMD
A max	185	185	330
N min	50	50	50
W ₁	8.4 + 1.5/-.00	12.4 + 2.0/-.00	16.4 + 2.0/-.00
W ₂ max	14.4	18.4	22.4

PolySwitch Resettable Devices

Automotive Devices

Figure A29 — EIA Referenced Taped Component Dimensions for AHS/ASMD/femtoASMDC/picoASMDC/nanoASMDC/microASMD/miniASMDC/ASMDC/nanoASMDCH PolySwitch Automotive Devices (in Millimeters)



Figure A30 — EIA Referenced Reel Dimensions for AHS/ASMD/femtoASMDC/picoASMDC/nanoASMDC/microASMD/miniASMDC/ASMDC/nanoASMDCH PolySwitch Automotive Devices



PolySwitch Resettable Devices

Automotive Devices

Part Numbering System



Warning :

- Users should independently evaluate the suitability of and test each product selected for their own application.
- Operation beyond the maximum ratings or improper use may result in device damage and possible electrical arcing and flame.
- These devices are intended for protection against damage caused by occasional overcurrent or overtemperature fault conditions and should not be used when repeated fault conditions or prolonged trip events are anticipated.
- Contamination of the PPTC material with certain silicone-based oils or some aggressive solvents can adversely impact the performance of the devices.
- Device performance can be impacted negatively if devices are handled in a manner inconsistent with recommended electronic, thermal, and mechanical procedures for electronic components.
- PPTC devices are not recommended for installation in applications where the device is constrained such that its PTC properties are inhibited, for example in rigid potting materials or in rigid housings, which lack adequate clearance to accommodate device expansion.
- Operation in circuits with a large inductance can generate a circuit voltage (Ldi/dt) above the rated voltage of the device.

Notice:

Information furnished is believed to be accurate and reliable. However, users should independently evaluate the suitability of and test each product selected for their own applications. Littelfuse products are not designed for, and shall not be used for, any purpose (including, without limitation, military, aerospace, medical, life-saving, life-sustaining or nuclear facility applications, devices intended for surgical implant into the body, or any other application in which the failure or lack of desired operation of the product may result in personal injury, death, or property damage) other than those expressly set forth in applicable Littelfuse product documentation. Warranties granted by Littelfuse shall be deemed void for products used for any purpose not expressly set forth in applicable Littelfuse documentation. Littelfuse shall not be liable for any claims or damages arising out of products used in applications not expressly intended by Littelfuse as set forth in applicable Littelfuse documentation. The sale and use of Littelfuse products is subject to Littelfuse Terms and Conditions of Sale, unless otherwise agreed by Littelfuse.