

CODE 88 - TINEL-LOCK BACKSHELL



TXR88AB00-0905AI-

SERIES _____
 TXR: RING INCLUDED
 (SEE RING OPTION)
 TX: RING NOT INCLUDED
 CONNECTOR INTERFACE _____
 MATERIAL _____
 REFER TO CH00-0250-008
 FINISH _____
 REFER TO CH00-0250-008
 ANGLE _____
 DASH NUMBER (TABLE 1) _____
 ENTRY SIZE (TABLE 2) _____
 RING OPTION _____
 AI - TO SUIT SINGLE BRAID
 BI - TO SUIT DOUBLE BRAID
 FOR TX, LEAVE BLANK
 MODIFICATION CODE _____
 REFER TO CH00-0250-008 (2)

NOTES:

- THIS PRODUCT IS DESIGNED TO TERMINATE A BRAIDED CABLE SHIELD AND A HEAT SHRINKABLE LIPPED BOOT TO A CONNECTOR.
- (2) FOR ADDITIONAL DIMENSIONS, ORDERING INFORMATION AND MODIFICATIONS, SEE CH00-0250-008.
- (3) SEE DRAWING TR FOR DETAIL ON TINEL-LOCK RING, RINGS ARE DESIGNED TO BE HEATED ELECTRICALLY, ALL RINGS ARE MARKED WITH THERMOCHROMIC PAINT WHICH CHANGES COLOUR WHEN INSTALLATION TEMPERATURE IS REACHED.
- BACKSHELL TO BE PERMANENTLY MARKED/BAGGED AND LABELLED WITH CODE IDENTIFICATION NUMBER AND PART NUMBER LESS RING DESIGNATOR. (e.g. 06090-TXR88AB00-0905). RING SHALL BEAR NO MARKING.
- BACKSHELL MATES TO: GLENAIR SERIES 800, 801, 803, 804 & 805 CONNECTORS.

If this document is printed it becomes uncontrolled. Check for the latest revision

DRAWN	K.WINCZURA	DATE 25/02/2015	 3RD ANGLE PROJECTION NOT TO SCALE	TITLE:	TINEL-LOCK BACKSHELL	 Polanco  TE connectivity	
CHECKED		25/02/2015					ASSY USED ON:
APPROVED	K.SHEPPARD	26/03/2015		UNLESS OTHERWISE SPECIFIED ALL DIMENSIONS IN MILLIMETRES GENERAL TOL LINEAR +/-0.25MM ANGULAR +/- 1°			
APPROVED	K.SMITH	20/08/2015					
REVISIONS							
LTR	DESCRIPTION	DATE	APPROVED				
D	REVISED PER ECO-12-021276	05/12/2012	SH				
E	REVISED PER ECO-15-011999	20/08/2015	K.SMITH				
TE CAGE CODE: 06090 POLAMCO/TE CAGE CODE: U5792				TE CONNECTIVITY - POLAMCO LTD RESERVES THE RIGHT TO AMEND THIS DRAWING AND THE INFORMATION SET FORTH HEREON AT ANY TIME. USERS SHOULD INDEPENDENTLY EVALUATE THE SUITABILITY OF THE PRODUCT FOR THEIR APPLICATION.	DRAWING NO: TXR88	DRAWING REV: E	SHT 1

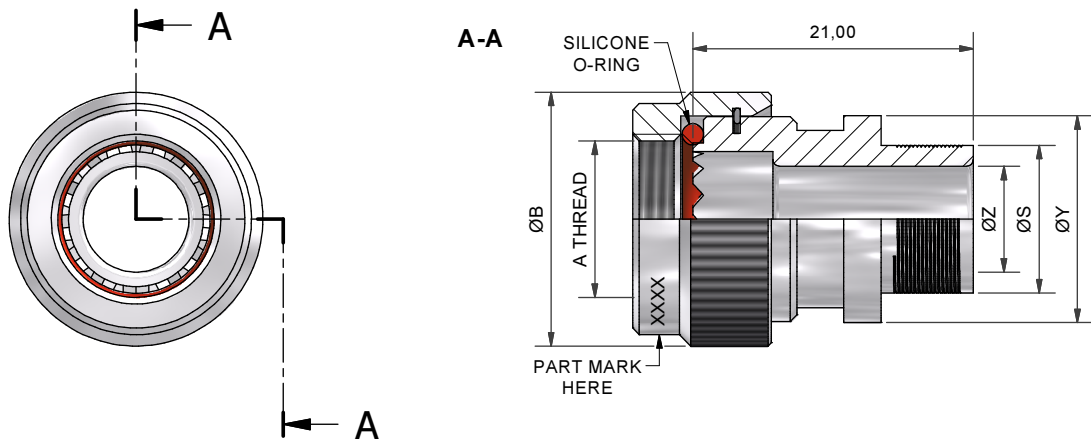





TABLE 1

ORDER NUMBER	SERIES 800	SERIES 801	SERIES 802	SERIES 803 & 804	SERIES 805	MAX ENTRY	A THREAD	ØB MAX
05	05	05	05	05	-	03	1/4-32UNEF	13,0
06	06	06	06	06	-	04	5/16-32UNEF	14,7
07	07	07	07	07	09	04	7-16-28UNEF	18,0
08	-	-	-	-	08	04	3/8-32UNEF	15,7
09	08	08	08	08	10	06	1/2-28UNEF	19,0
10	09	09	09	09	11	06	9/16-24UNEF	21,2
11	10	10	10	10	12	08	5/8-24UNEF	22,0
12	12	13	12	12	-	08	11/16-24UNEF	25,5
13	-	-	-	-	15	08	3/4-20UNEF	25,5
14	-	-	14	-	-	10	7/8-20UNEF	28,0
15	-	16-17	15	14-15	18-19	12	15/16-20UNEF	34,3

TABLE 2

ENTRY SIZE	ØZ +0,13/-0	ØS	ØY +/-0,3
03	4,75	7,36 +/-0,03	10,60
04	6,35	9,49 +/-0,04	14,00
05	7,92	11,06 +/-0,04	15,50
06	9,53	12,66 +/-0,04	17,10
07	11,10	14,21 +/-0,07	18,70
08	12,70	15,81 +/-0,07	20,30
10	15,88	18,96 +/-0,08	23,50
12	19,05	22,14 +/-0,08	26,70

If this document is printed it becomes uncontrolled. Check for the latest revision

DRAWN	K.WINCZURA	DATE	25/02/2015	 3RD ANGLE PROJECTION NOT TO SCALE	TINEL-LOCK BACKSHELL	 Polamco
CHECKED		25/02/2015				
APPROVED	K.SHEPPARD	26/03/2015	UNLESS OTHERWISE SPECIFIED ALL DIMENSIONS IN MILLIMETRES GENERAL TOL LINEAR +/-0,25MM ANGULAR +/- 1°			
APPROVED	K.SMITH	20/08/2015				
REVISIONS					ASSY USED ON:	 TE connectivity
LTR	DESCRIPTION	DATE	APPROVED	MIGHTY MOUSE 800-805 SERIES		
D	REVISED PER ECO-12-021276	05/12/2012	SH			
E	REVISED PER ECO-15-011999	20/08/2015	K.SMITH			
TE CAGE CODE: 06090 POLAMCO/TE CAGE CODE: U5792					TE CONNECTIVITY - POLAMCO LTD RESERVES THE RIGHT TO AMEND THIS DRAWING AND THE INFORMATION SET FORTH HEREON AT ANY TIME. USERS SHOULD INDEPENDENTLY EVALUATE THE SUITABILITY OF THE PRODUCT FOR THEIR APPLICATION.	DRAWING NO: TXR88
					DRAWING REV: E	SHT 2