

KEMET Part Number: SN10-500J
(UALSN10500J000)

KEMET, SN-J, AC Line Filters, Normal Mode, 110 uH

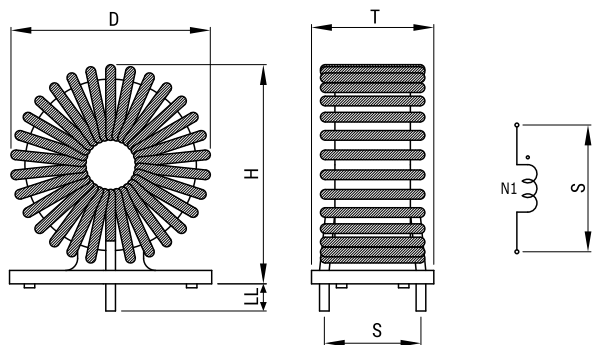

Dimensions

D	23mm MAX
W	22mm NOM
T	16mm MAX
H	26mm MAX
LL	7mm +/-2mm
S	10mm NOM

Packaging Specifications

Packaging:	Tray
Packaging Quantity:	600
Weight:	14 g

General Information

Series:	SN-J
Style:	Through-Hole
RoHS:	Yes
Miscellaneous:	30 (K) Temperature Rise Max.

Specifications

Inductance:	110 uH (0.1 MHz)
Current:	3 A
Temperature Range:	-25/+105°C
DC Resistance:	71 mOhms