

IGBT Modules

H-Bridge

Trench IGBT

$I_{C25} = 89 A$
 $V_{CES} = 600 V$
 $V_{CE(sat) \text{ typ.}} = 1.8 V$

Preliminary data

Part name (Marking on product)

MKI 80-06T6K

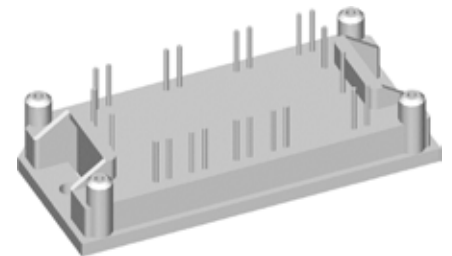
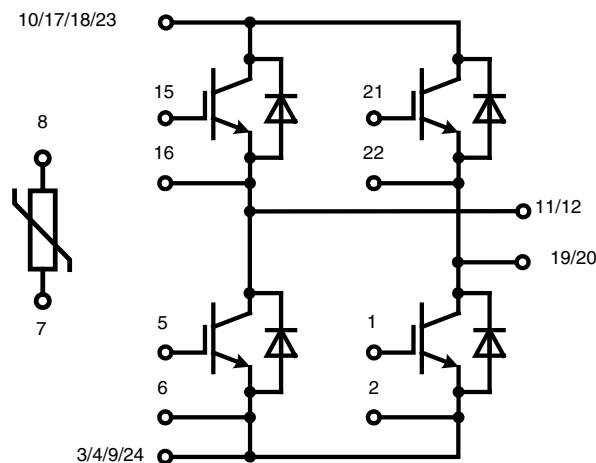

Features:

- Trench IGBT technology
- Low saturation voltage
- Low switching losses
- Square RBSOA, no latch up
- High short circuit capability
- Positive temperature coefficient for easy parallelling
- MOS input, voltage controlled
- Ultra fast free wheeling diodes
- Solderable pins for PCB mounting
- Space saving
- Reduced protection circuits

Application:

- AC motor control
- AC servo and robot drives
- Power supplies

Package:

- Industry standard E1-pack
- Designed for wave soldering
- With copper base plate

| IGBTs | | | | | | |
|---------------------|---------------------------------------|---|---------|------|------------|---------------|
| Symbol | Definitions | Conditions | Ratings | | | Unit |
| | | | min. | typ. | max. | |
| V_{CES} | collector emitter voltage | $T_{VJ} = 25^{\circ}\text{C to } 150^{\circ}\text{C}$ | | | 600 | V |
| V_{GES} | max. DC gate voltage | continuous | | | ± 20 | V |
| V_{GEM} | max. transient collector gate voltage | transient | | | ± 30 | V |
| I_{C25} | collector current | $T_C = 25^{\circ}\text{C}$ | | | 89 | A |
| I_{C80} | | $T_C = 80^{\circ}\text{C}$ | | | 67 | A |
| P_{tot} | total power dissipation | $T_C = 25^{\circ}\text{C}$ | | | 210 | W |
| $V_{CE(sat)}$ | collector emitter saturation voltage | $I_C = 75\text{ A}; V_{GE} = 15\text{ V}$ | | | 1.8 2.3 | V V |
| $V_{GE(th)}$ | gate emitter threshold voltage | $I_C = 1.2\text{ mA}; V_{GE} = V_{CE}$ | 5 | | 6.5 | V |
| I_{CES} | collector emitter leakage current | $V_{CE} = V_{CES}; V_{GE} = 0\text{ V}$ | | | 0.5 | mA mA |
| I_{GES} | gate emitter leakage current | $V_{CE} = 0\text{ V}; V_{GE} = \pm 20\text{ V}$ | | | 400 | nA |
| C_{ies} | input capacitance | $V_{CE} = 25\text{ V}; V_{GE} = 0\text{ V}; f = 1\text{ MHz}$ | | | 4620 | pF |
| $Q_{G(on)}$ | total gate charge | $V_{CE} = 480\text{ V}; V_{GE} = 15\text{ V}; I_C = 75\text{ A}$ | | | 470 | nC |
| $t_{d(on)}$ | turn-on delay time | inductive load $V_{CE} = 300\text{ V}; I_C = 75\text{ A}$ $V_{GE} = \pm 15\text{ V}; R_G = 5.1\ \Omega$ | | | | |
| t_r | current rise time | | | | | |
| $t_{d(off)}$ | turn-off delay time | | | | | |
| t_f | current fall time | | | | | |
| E_{on} | turn-on energy per pulse | | | | | |
| E_{off} | turn-off energy per pulse | | | | | |
| I_{CM} | reverse bias safe operating area | RBSOA; $V_{GE} = \pm 15\text{ V}; R_G = 5.1\ \Omega; L = 100\ \mu\text{H}$ | | | 150 | A |
| V_{CEK} | | clamped inductive load; $T_{VJ} = 125^{\circ}\text{C}$ | | | 0.9x | V_{CES} |
| t_{SC} (SCSOA) | short circuit safe operating area | $V_{CE} = 480\text{ V}; V_{GE} = \pm 15\text{ V}; R_G = 5.1\ \Omega; \text{non-repetitive}$ | | | 6 | μs |
| R_{thJC} | thermal resistance junction to case | (per IGBT) | | | 0.6 | K/W |
| R_{thCH} | thermal resistance case to heatsink | (per IGBT) | | | 0.2 | K/W |

| Diodes | | | | | | |
|------------|-------------------------------------|--|---|------------|------|--------|
| Symbol | Definitions | Conditions | Maximum Ratings | | | Unit |
| | | | min. | typ. | max. | |
| V_{RRM} | max. repetitive reverse voltage | | | | 600 | V |
| I_{F25} | forward current | $T_C = 25^{\circ}\text{C}$ | | | 105 | A |
| I_{F80} | | $T_C = 80^{\circ}\text{C}$ | | | 67 | A |
| Symbol | Conditions | Characteristic Values | | | | Unit |
| | | min. | typ. | max. | | |
| V_F | forward voltage | $I_F = 75\text{ A}$ | $T_{VJ} = 25^{\circ}\text{C}$ $T_{VJ} = 125^{\circ}\text{C}$ | 1.8 1.6 | 2.2 | V V |
| I_{RM} | max. reverse recovery current | $V_R = 300\text{ V}; I_F = 75\text{ A}$ $di_F/dt = -600\text{ A}/\mu\text{s}$ | $T_{VJ} = 100^{\circ}\text{C}$ | 36 | | A |
| t_{rr} | reverse recovery time | | | 100 | | ns |
| R_{thJC} | thermal resistance junction to case | (per diode) | $T_{VJ} = 25^{\circ}\text{C}$ | | 0.65 | K/W |
| R_{thCH} | thermal resistance case to heatsink | (per diode) | | 0.25 | | K/W |

Temperature Sensor NTC

| Symbol | Definitions | Conditions | Ratings | | | Unit |
|-------------|-------------------|--------------------------|---------|------|------|------------|
| | | | min. | typ. | max. | |
| R_{25} | <i>resistance</i> | $T_C = 25^\circ\text{C}$ | 4.45 | 4.7 | 5.0 | k Ω |
| $B_{25/85}$ | | | | 3510 | | K |

Module

| Symbol | Definitions | Conditions | Ratings | | | Unit |
|---------------|--|--|---------|------|------|------------------|
| | | | min. | typ. | max. | |
| T_{VJ} | <i>operating temperature</i> | | -40 | | 125 | $^\circ\text{C}$ |
| T_{VJM} | <i>max. virtual junction temperature</i> | | | | 175 | $^\circ\text{C}$ |
| T_{stg} | <i>storage temperature</i> | | -40 | | 125 | $^\circ\text{C}$ |
| V_{ISOL} | <i>isolation voltage</i> | $I_{ISOL} \leq 1 \text{ mA}; 50/60 \text{ Hz}$ | | | 2500 | V~ |
| M_d | <i>mounting torque</i> | (M4) | 2.0 | | 2.2 | Nm |
| d_s | <i>creep distance on surface</i> | | 12.7 | | | mm |
| d_A | <i>strike distance through air</i> | | 12.7 | | | mm |
| Weight | | | | 40 | | g |

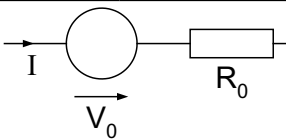
Equivalent Circuits for Simulation

Ratings

| Symbol | Definitions | Conditions | min. | typ. | max. | Unit |
|--------|----------------------------|------------------------------|------|------|------|------------|
| V_0 | <i>IGBT</i> | $T_{VJ} = 125^\circ\text{C}$ | | 0.9 | | V |
| R_0 | | | | 14.3 | | m Ω |
| V_0 | <i>free wheeling diode</i> | $T_{VJ} = 125^\circ\text{C}$ | | 1.25 | | V |
| R_0 | | | | 3 | | m Ω |

Outline Drawing

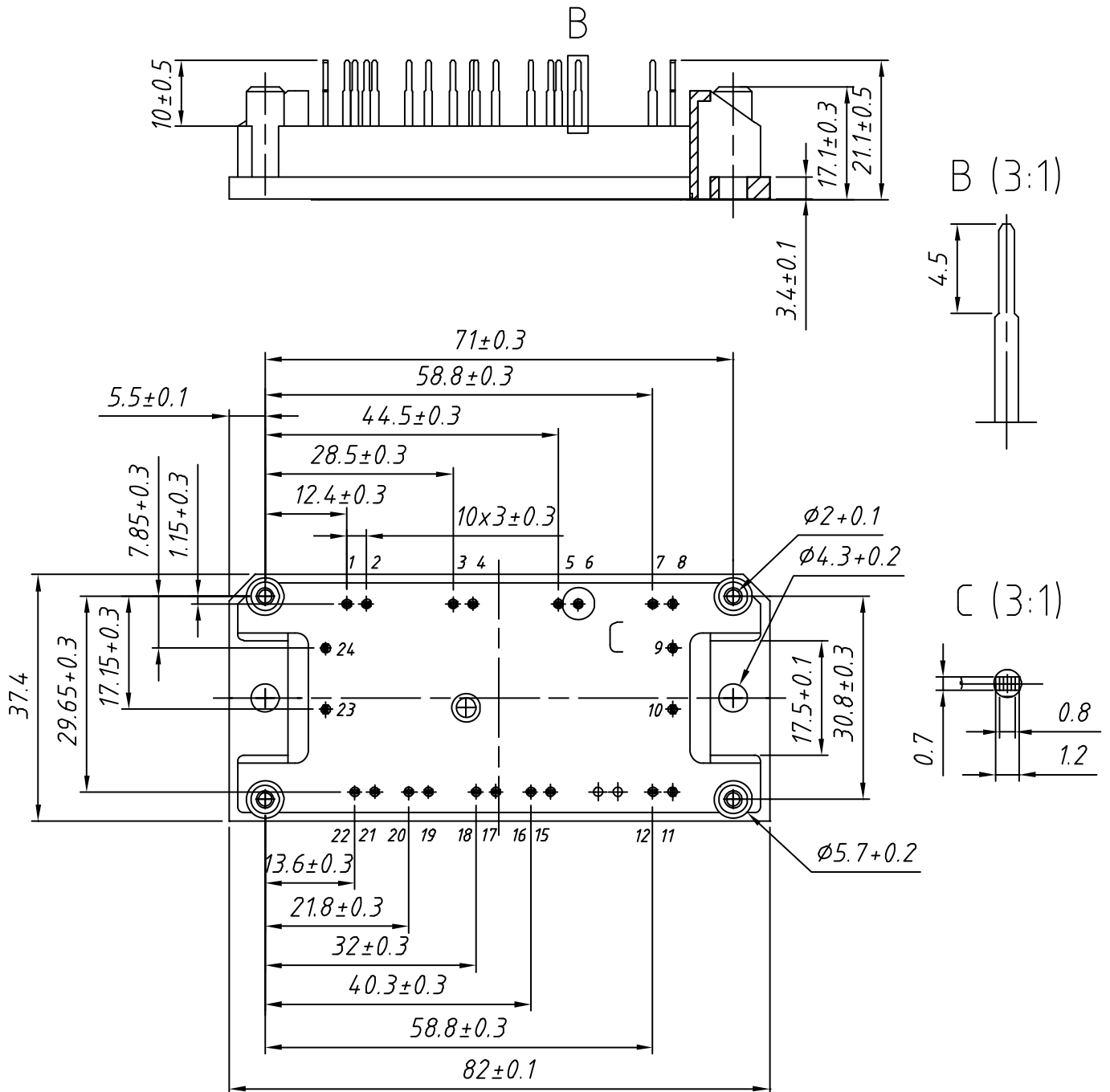
Dimensions in mm (1 mm = 0.0394")



Product Marking

| Ordering | Part Name | Marking on Product | Delivering Mode | Base Qty | Ordering Code |
|----------|--------------|--------------------|-----------------|----------|---------------|
| Standard | MKI 80-06T6K | MKI80-06T6K | Box | 10 | 504061 |

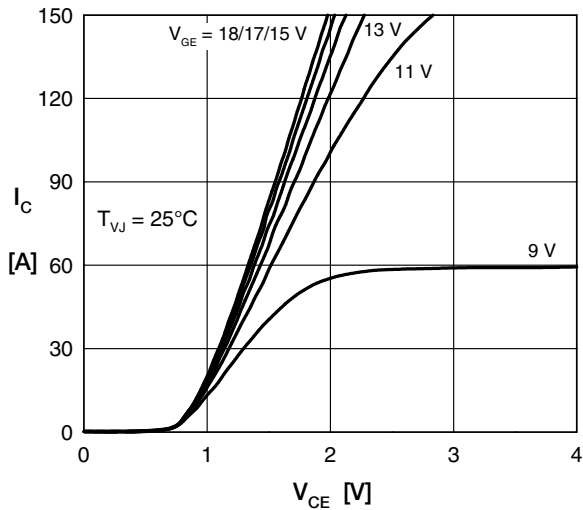

Fig. 1 Typical output characteristics

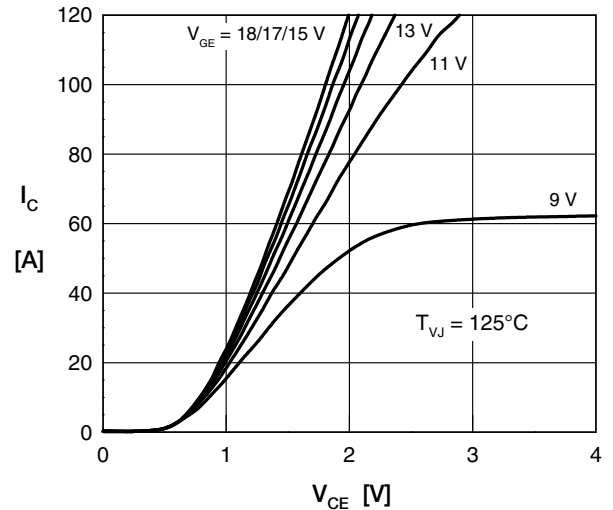

Fig. 2 Typical output characteristics

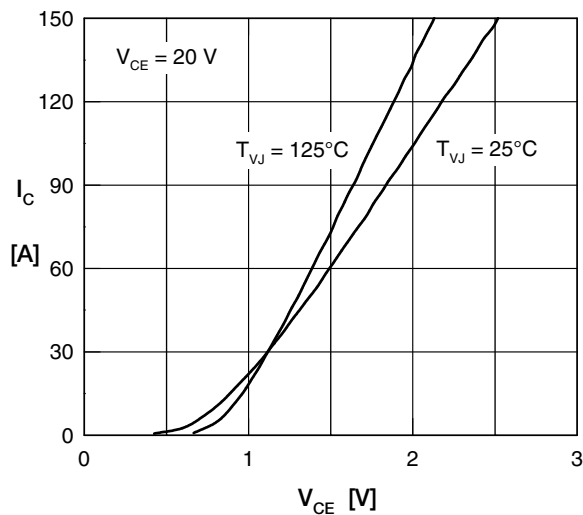

Fig. 3 Typical output characteristics

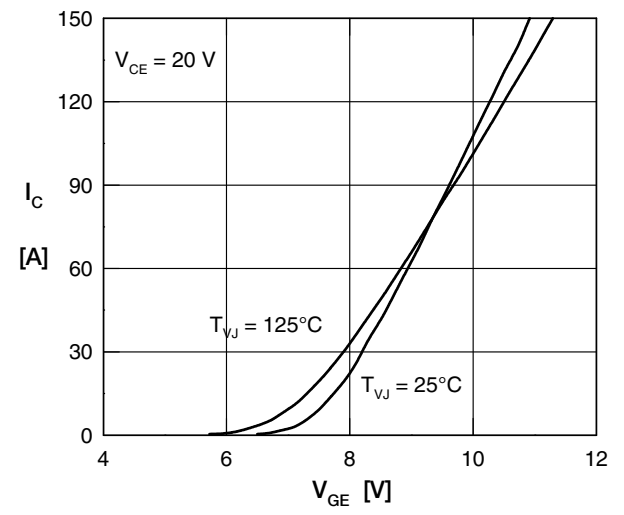

Fig. 4 Typical transfer characteristics

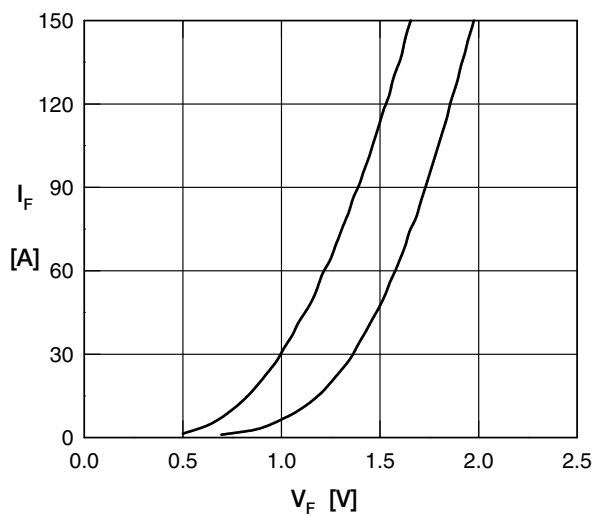

Fig. 5 Typical forward characteristics FWD

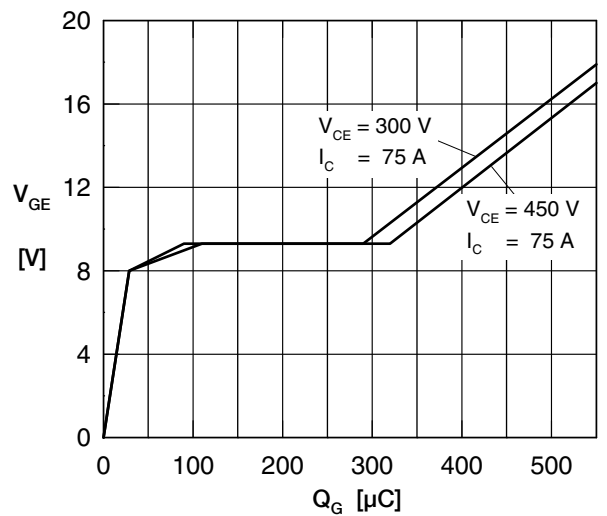

Fig. 6 Typical turn-on gate charge