

**SERIES:** CP60H | **DESCRIPTION:** PELTIER MODULE**FEATURES**

- arcTEC™ structure on select models
- enhanced reliability for high thermal cycling
- superior thermal performance
- silicon sealed
- wide  $\Delta T$  max
- low profile
- precise temperature control
- solid state construction



MODEL	input voltage <sup>1</sup>	input current <sup>2</sup>	internal resistance <sup>3</sup>	output Qmax <sup>4</sup>		output $\Delta T$ max <sup>5</sup>	
	max (Vdc)	max (A)	typ ( $\Omega \pm 10\%$ )	$T_h = 27^\circ\text{C}$ (W)	$T_h = 50^\circ\text{C}$ (W)	$T_h = 27^\circ\text{C}$ ( $^\circ\text{C}$ )	$T_h = 50^\circ\text{C}$ ( $^\circ\text{C}$ )
CP60131H	3.8	6.0	0.45	13	14.3	70	77
CP60139H	2.1	6.0	0.30	7.4	8.2	70	77
CP60231H	8.8	6.0	1.05	29.7	32.7	70	77
CP60239H	3.8	6.0	0.55	13.6	14.9	70	77
CP602040395H <sup>6</sup>	7.6	6.0	1.09	27.5	30.2	70	77
CP60301233H	5.6	6.0	0.76	19.7	21.7	70	77
CP60301531H	7.6	6.0	0.93	26.3	28.9	70	77
CP603315H <sup>6</sup>	15.7	6.0	1.90	53.1	59.1	70	77
CP6030395 <sup>6</sup>	11.8	6.0	1.65	41.5	45.6	70	77
CP603395H <sup>6</sup>	8.8	6.0	1.25	31.1	34.2	70	77
CP604020395H <sup>6</sup>	7.6	6.0	1.09	27.5	30.2	70	77
CP60433H <sup>6</sup>	19.5	6.0	2.54	67.6	74.3	68	75
CP604395H <sup>6</sup>	15.7	6.0	2.2	55.6	61.0	70	77
CP604040 <sup>6</sup>	24.1	6.0	3.21	83.5	91.9	68	75
CP60546241 <sup>6</sup>	41.3	6.0	5.78	147	161	70	77
CP6055354 <sup>6</sup>	35.4	6.0	4.95	126	138	70	77
CP60555542 <sup>6</sup>	29.8	6.0	4.15	106	116	70	77
CP604060395 <sup>6</sup>	23.6	6.0	3.3	80.2	88.2	70	77

- Notes:
1. Maximum voltage at  $\Delta T$  max and  $T_h = 27^\circ\text{C}$
  2. Maximum current to achieve  $\Delta T$  max
  3. Measured by AC 4-terminal method at  $25^\circ\text{C}$
  4. Maximum heat absorbed at cold side occurs at  $I_{max}$ ,  $V_{max}$ , and  $\Delta T = 0^\circ\text{C}$
  5. Maximum temperature difference occurs at  $I_{max}$ ,  $V_{max}$ , and  $Q = 0\text{W}$  ( $\Delta T$  max measured in a vacuum at 1.3 Pa)
  6. Designed with arcTEC™ structure.

## SPECIFICATIONS

parameter	conditions/description	min	typ	max	units
solder melting temperature	connection between thermoelectric pairs	235			°C
assembly compression				1	MPa
RoHS	yes				

## MECHANICAL DRAWING

units: mm



	MATERIAL	PLATING
ceramic plate	96% AL <sub>2</sub> O <sub>3</sub>	
wire leads (CP60131H, CP60231H, CP60301233H, CP60301531H, CP603315H)	22 AWG	tin
wire leads (all other models)	20 AWG	tin
sealer	silicon rubber 703 RTV (between cold and hot side plates)	
joint cover	silicon rubber 703 RTV	
marking	P/N & S/N printed on cold side surface	

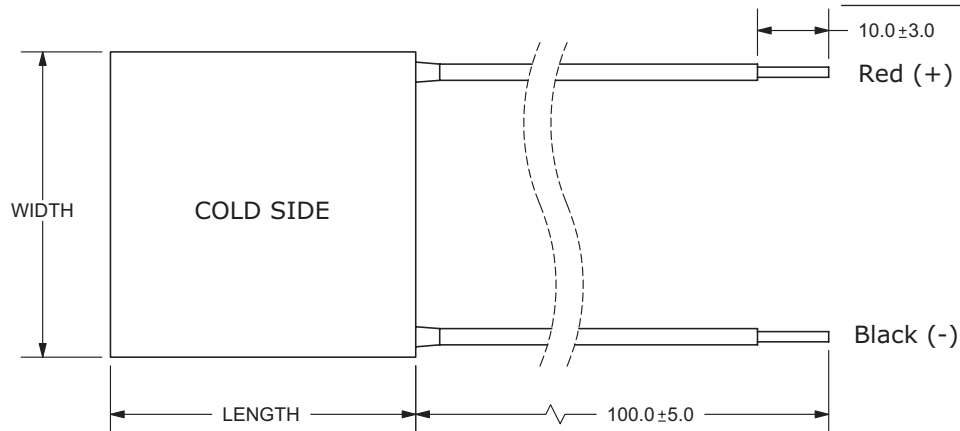

MODEL NO.	LENGTH (mm)	WIDTH (mm)	THICKNESS (mm)	MODEL NO.	LENGTH (mm)	WIDTH (mm)	THICKNESS (mm)
CP60131H	15 ±0.3	15 ±0.3	3.1 ±0.025	CP603395H	30 ±0.3	30 ±0.3	3.95 ±0.025
CP60139H	15 ±0.3	15 ±0.3	3.9 ±0.025	CP604020395H	40 ±0.3	20 ±0.3	3.95 ±0.025
CP60231H	20 ±0.3	20 ±0.3	3.1 ±0.025	CP60433H	40 ±0.3	40 ±0.3	3.3 ±0.03
CP60239H	20 ±0.3	20 ±0.3	3.9 ±0.025	CP604395H	40 ±0.3	40 ±0.3	3.95 ±0.025
CP602040395H	20 ±0.3	40 ±0.3	3.95 ±0.025	CP604040	40 ±0.3	40 ±0.3	4.0 ±0.1
CP60301233H	30 ±0.1	12 ±0.1	3.3 ±0.1	CP60546241	62.5 ±0.3	54 ±0.3	4.1 ±0.1
CP60301531H	30 ±0.3	15 ±0.3	3.1 ±0.025	CP6055354	55 ±0.3	55 ±0.3	4.1 ±0.1
CP603315H	30 ±0.3	30 ±0.3	3.15 ±0.025	CP60555542	55 ±0.3	55 ±0.3	4.2 ±0.1
CP6030395	30 ±0.3	30 ±0.3	3.95 ±0.025	CP604060395	40 ±0.3	60 ±0.3	3.95 ±0.025

### CP60131H PERFORMANCE (Th=27°C)

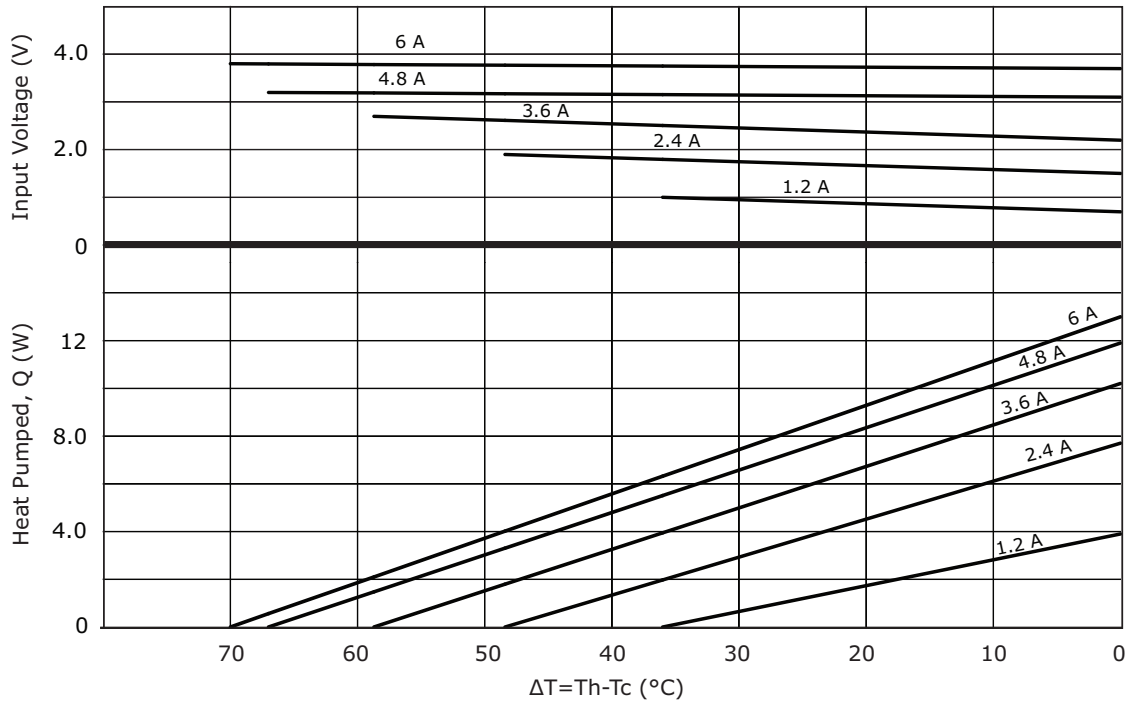

### CP60131H PERFORMANCE (Th=50°C)



### CP60139H PERFORMANCE (Th=27°C)



### CP60139H PERFORMANCE (Th=50°C)



### CP60231H PERFORMANCE (Th=27°C)

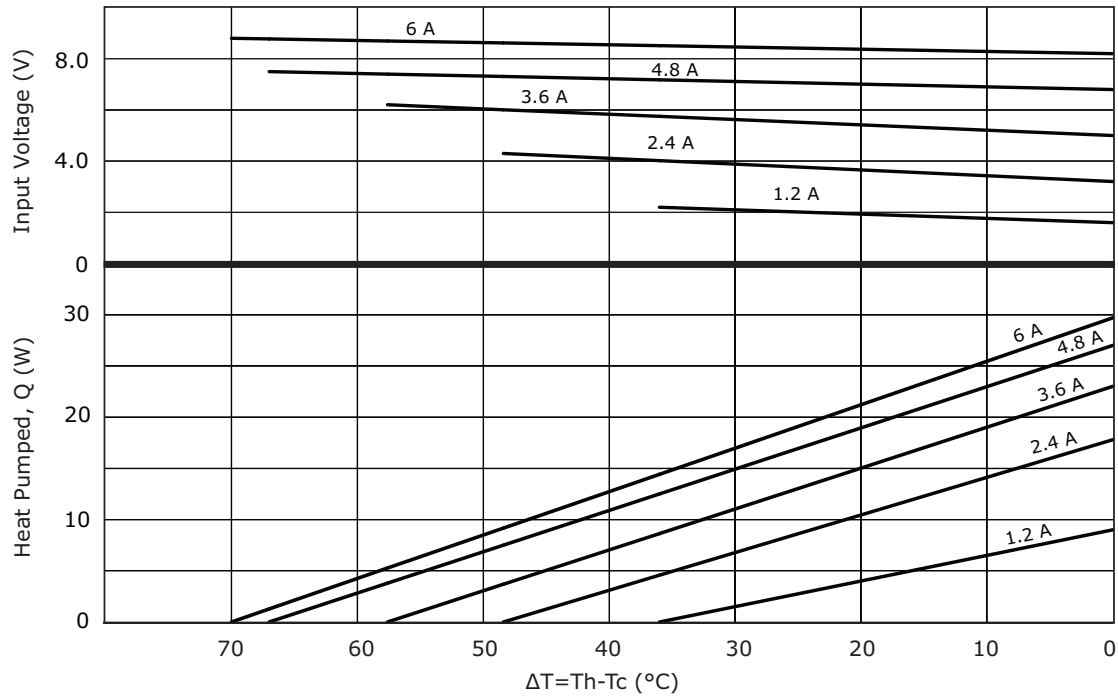

### CP60231H PERFORMANCE (Th=50°C)

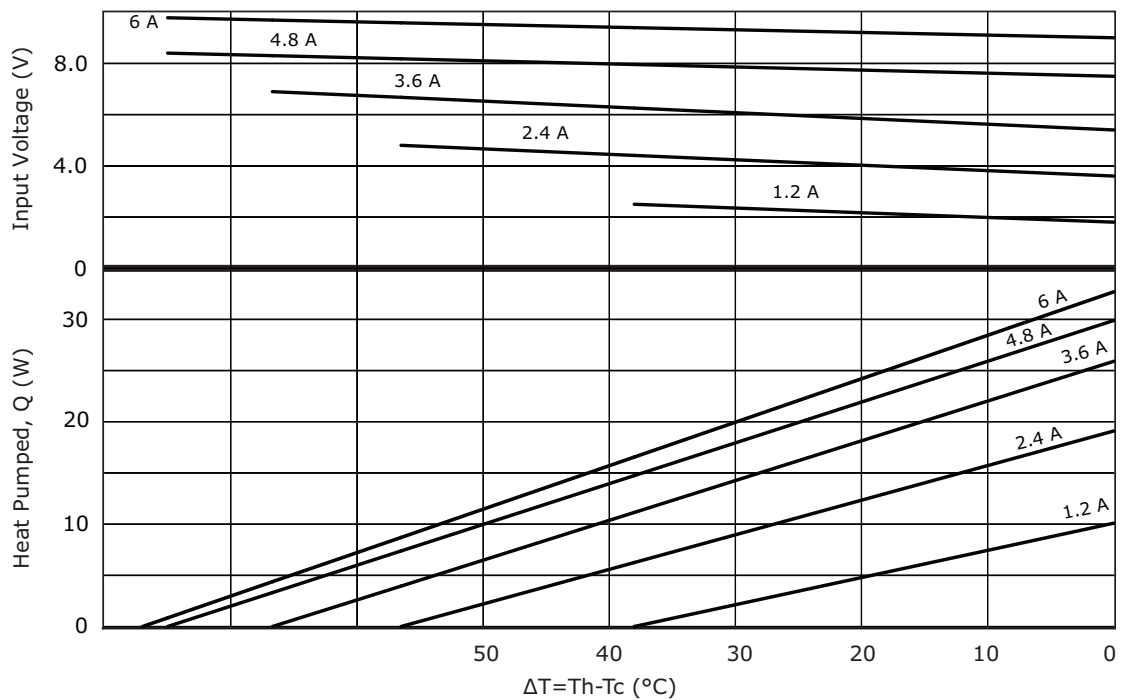

### CP60239H PERFORMANCE (Th=27°C)

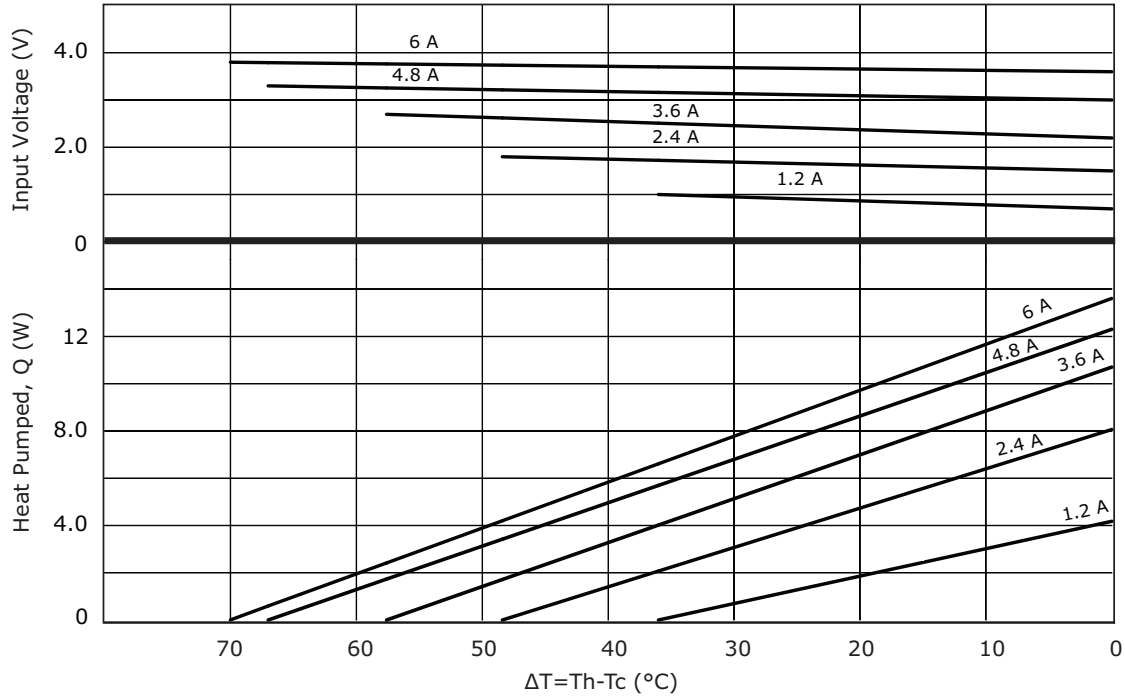

### CP60239H PERFORMANCE (Th=50°C)

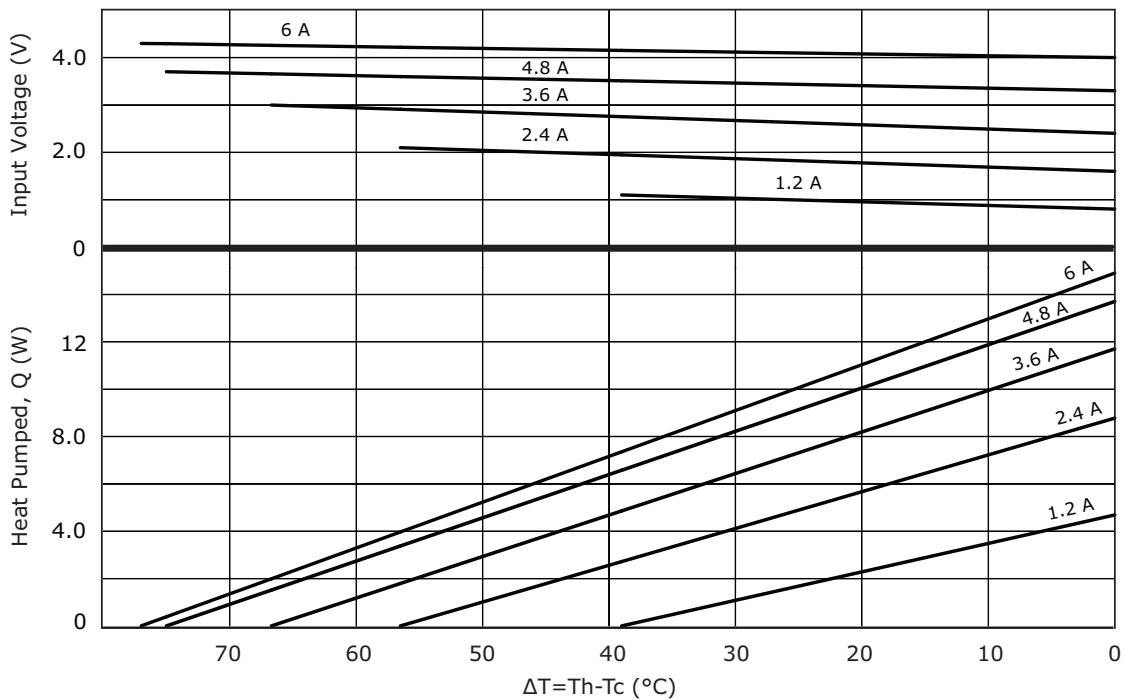

### CP602040395H PERFORMANCE (Th=27°C)



### CP602040395H PERFORMANCE (Th=50°C)

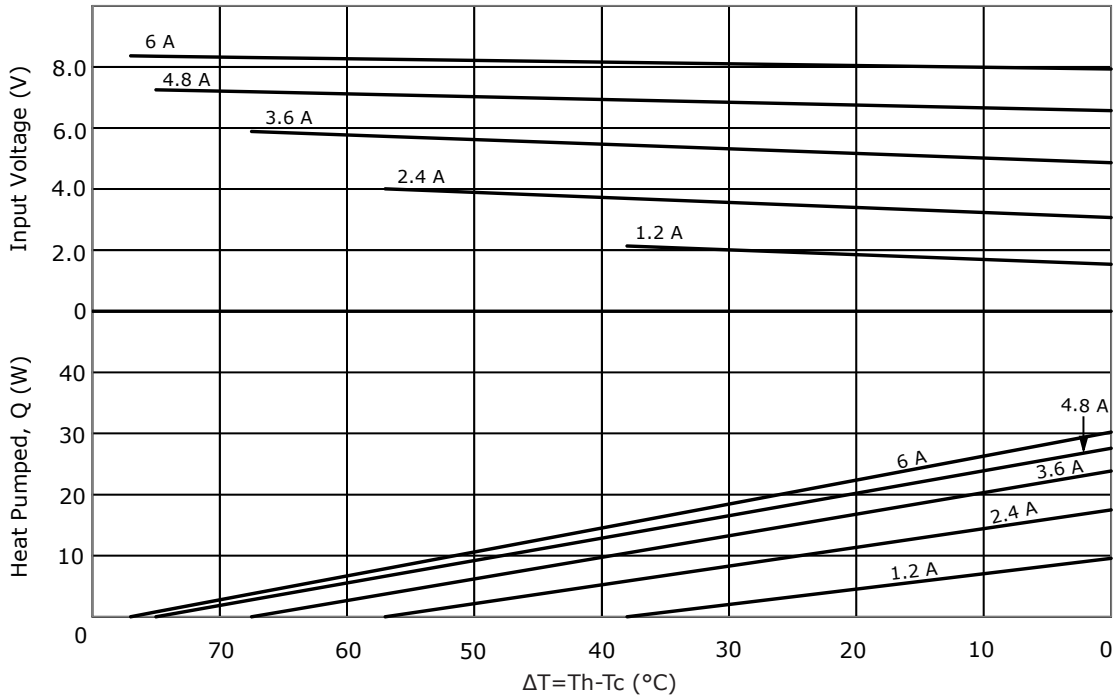

### CP60301233H PERFORMANCE (Th=27°C)

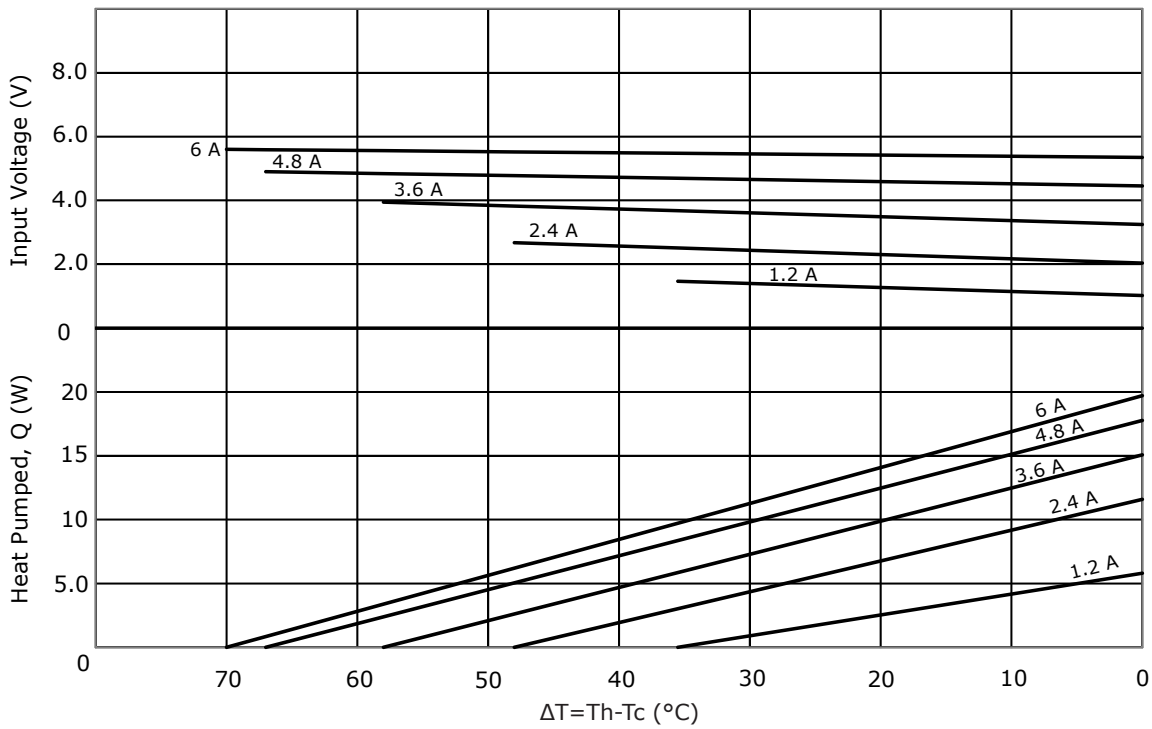

### CP60301233H PERFORMANCE (Th=50°C)

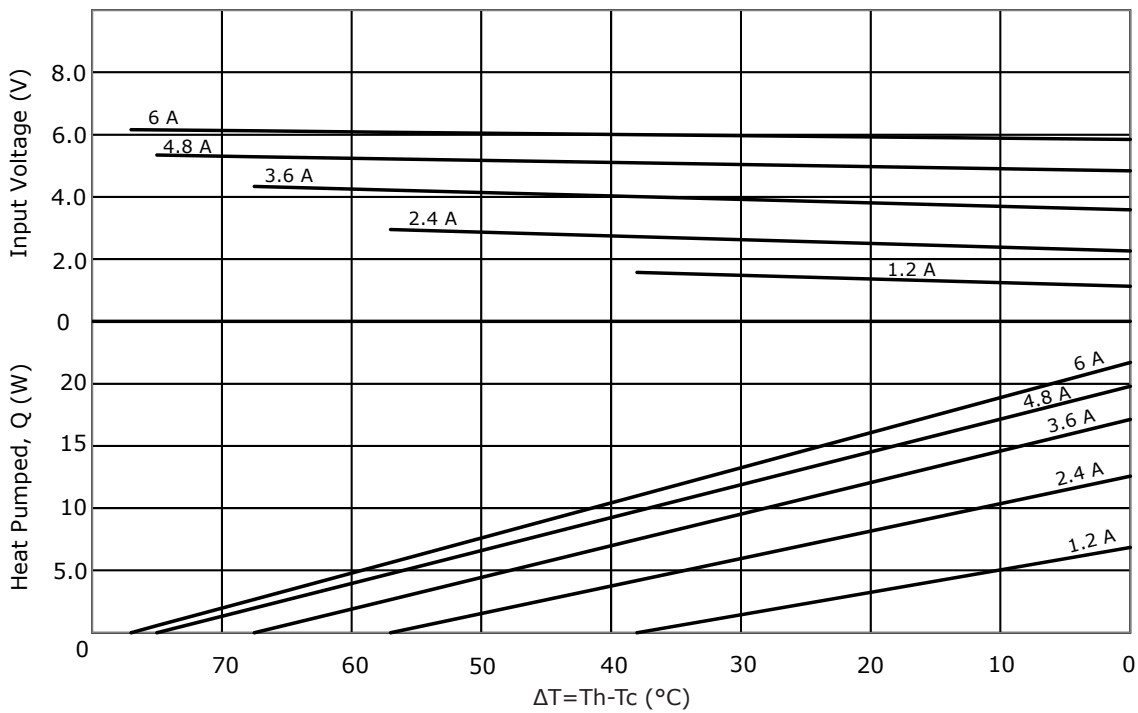



### CP60301531H PERFORMANCE (Th=27°C)

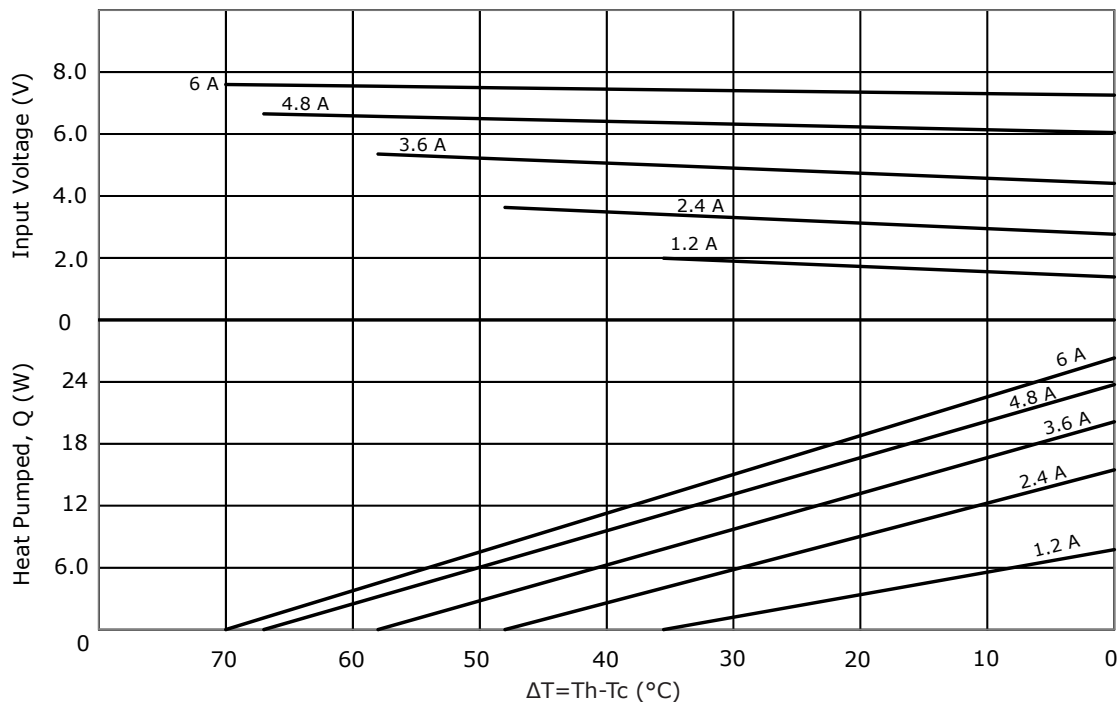

### CP60301531H PERFORMANCE (Th=50°C)



### CP603315H PERFORMANCE (Th=27°C)

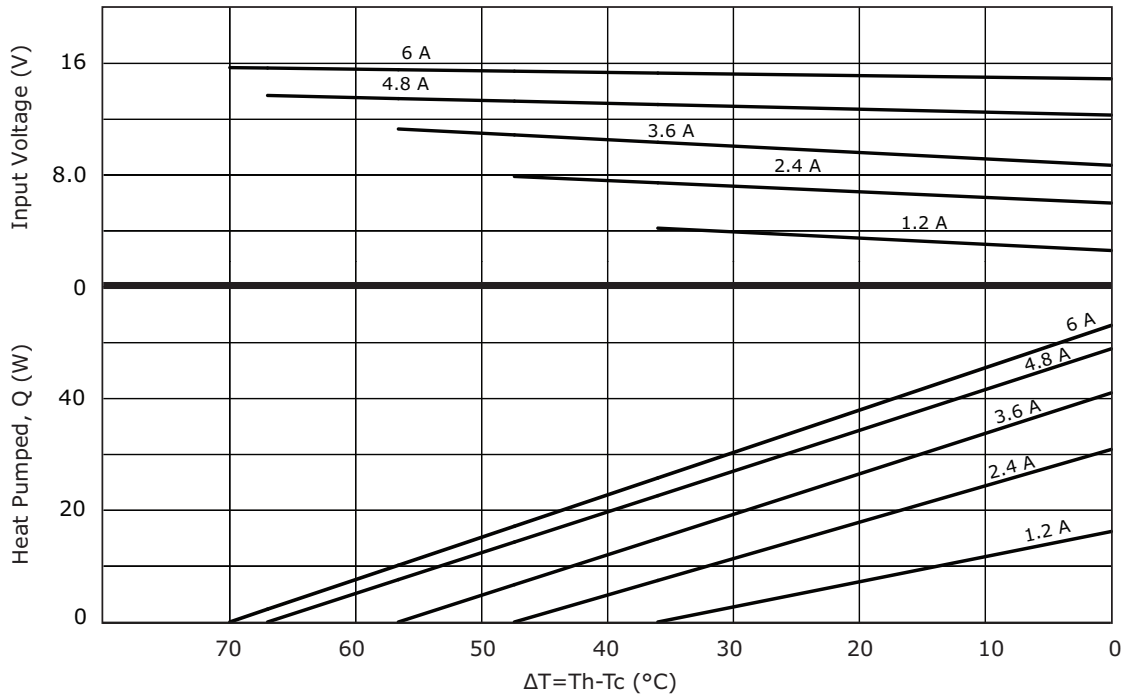

### CP603315H PERFORMANCE (Th=50°C)

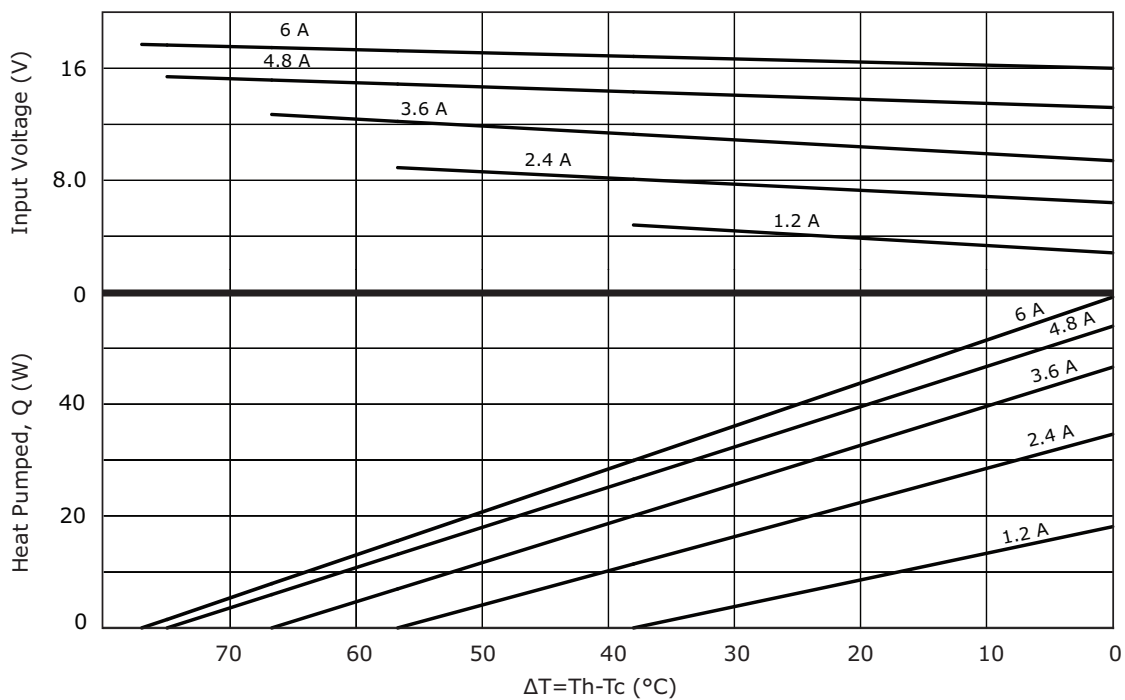

### CP6030395 PERFORMANCE (Th=27°C)

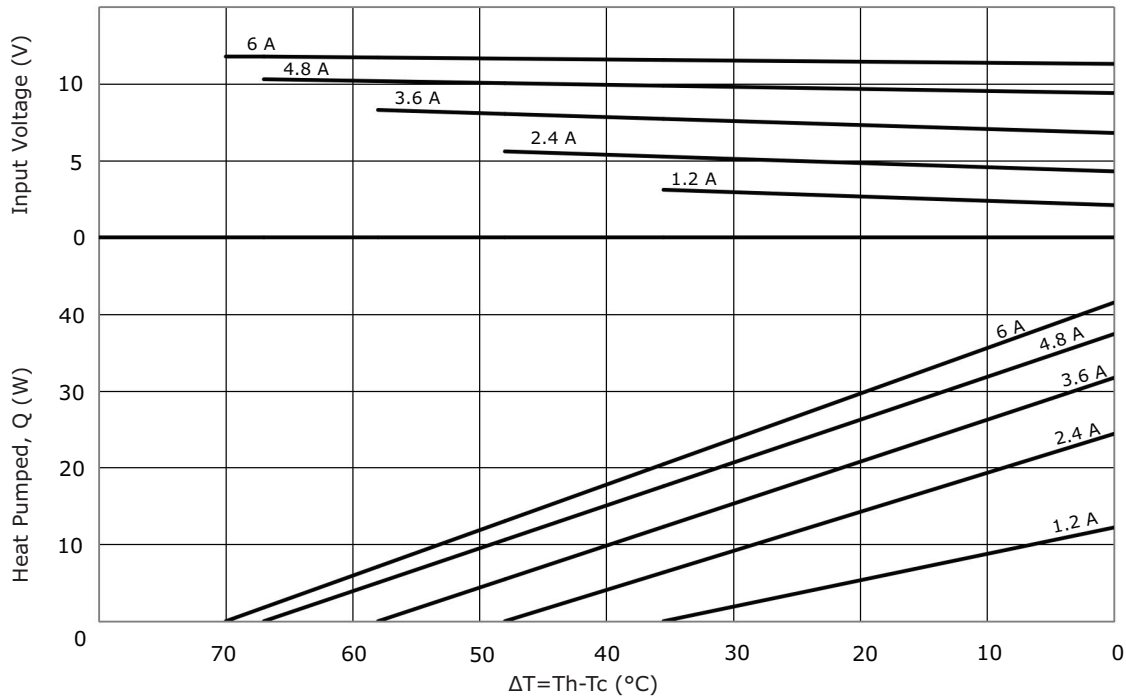

### CP6030395 PERFORMANCE (Th=50°C)

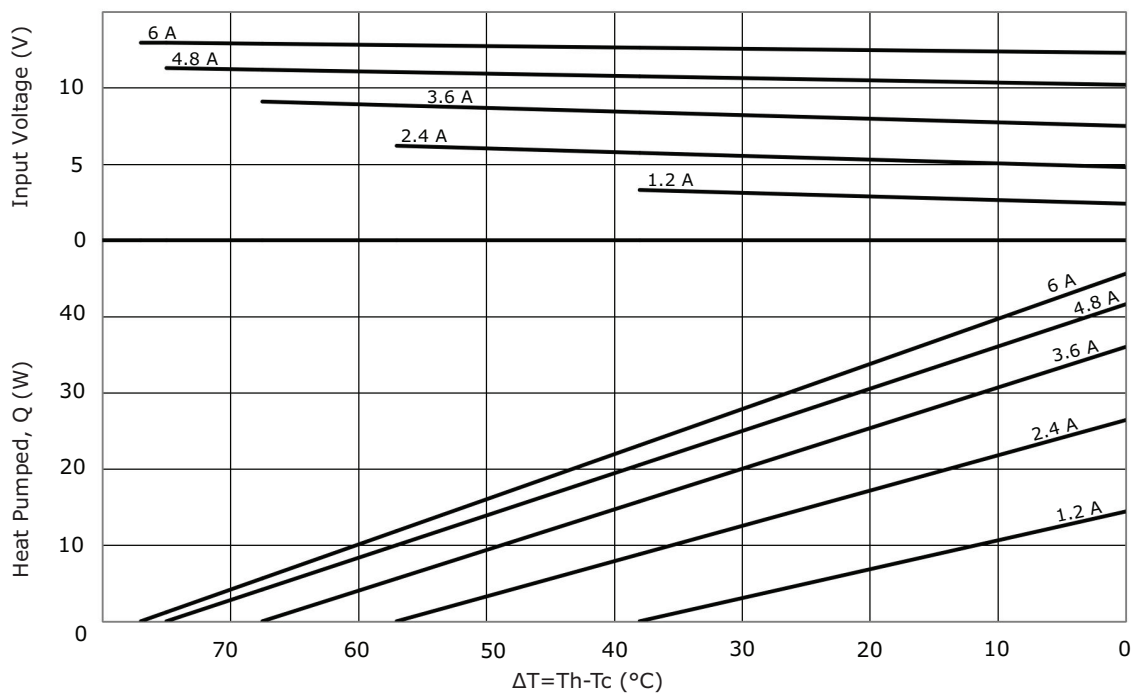

### CP603395H PERFORMANCE (Th=27°C)

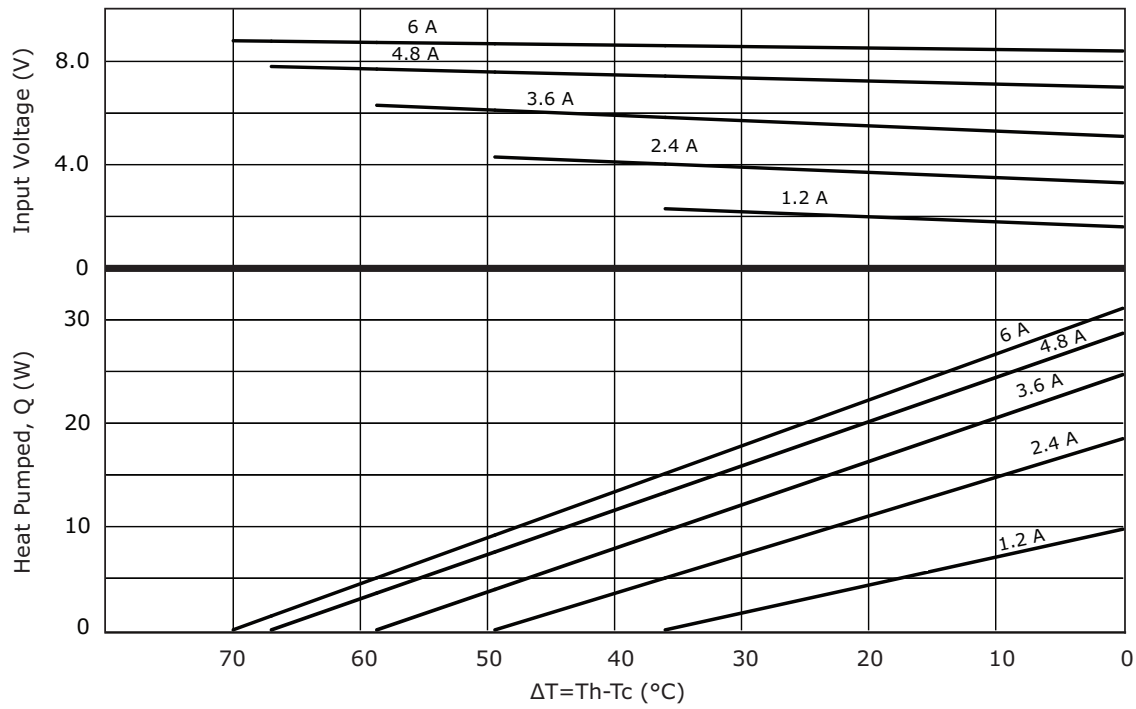

### CP603395H PERFORMANCE (Th=50°C)

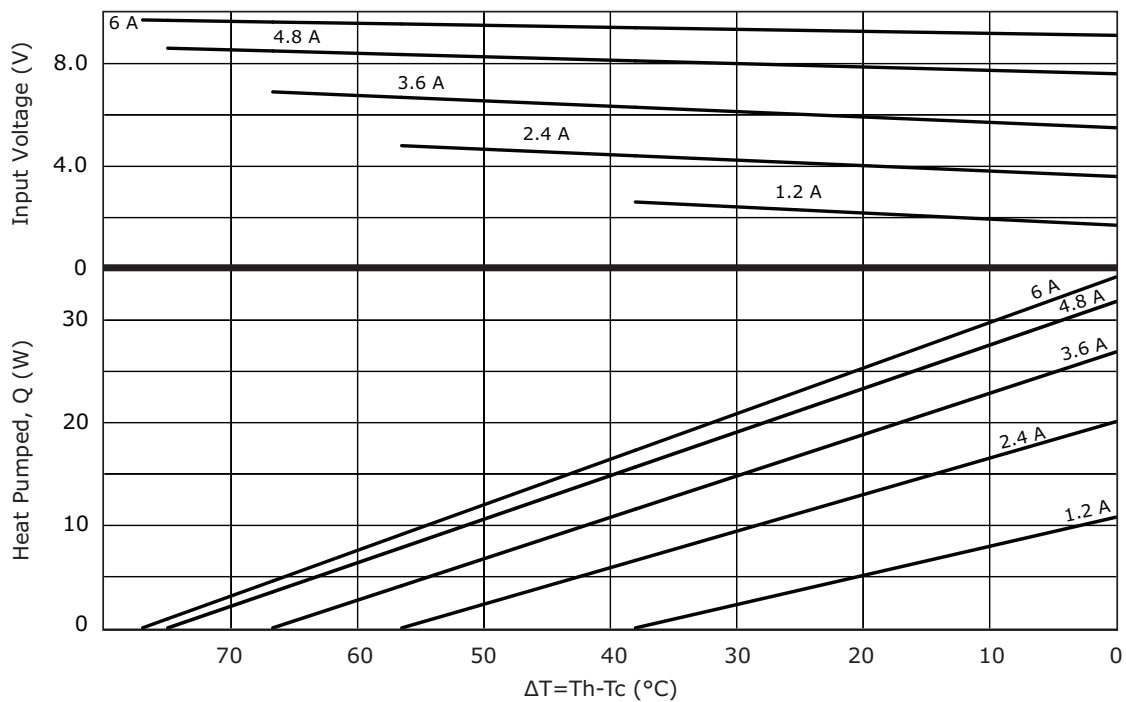

### CP604020395H PERFORMANCE (Th=27°C)

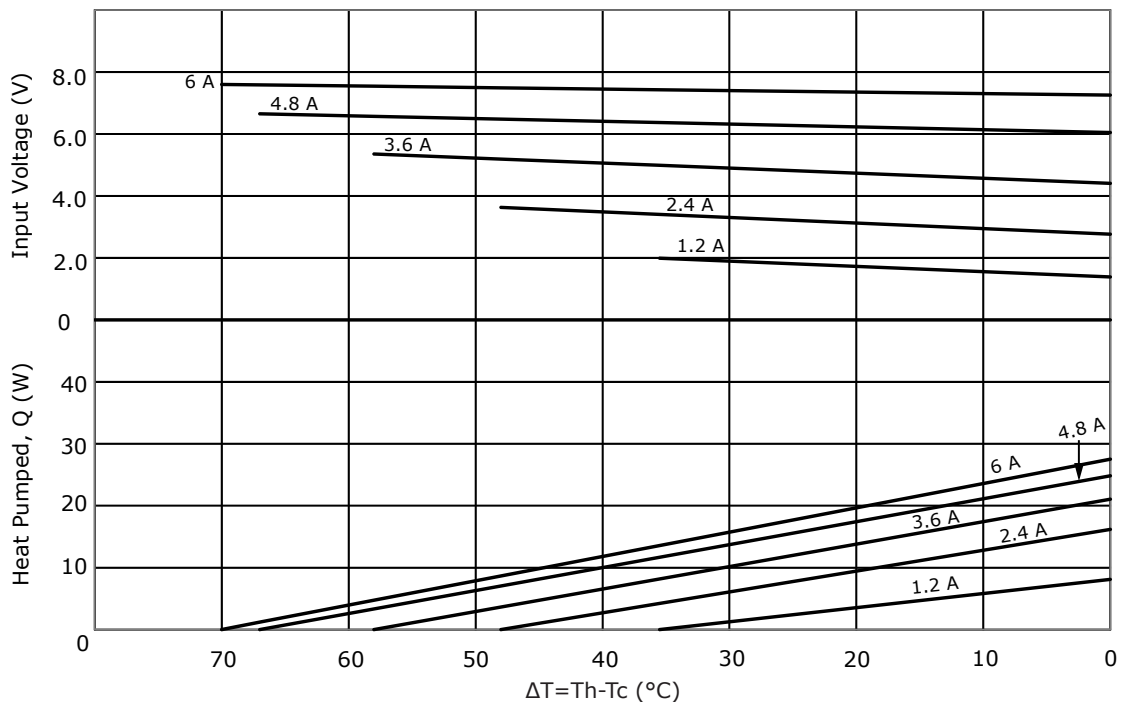

### CP604020395H PERFORMANCE (Th=50°C)

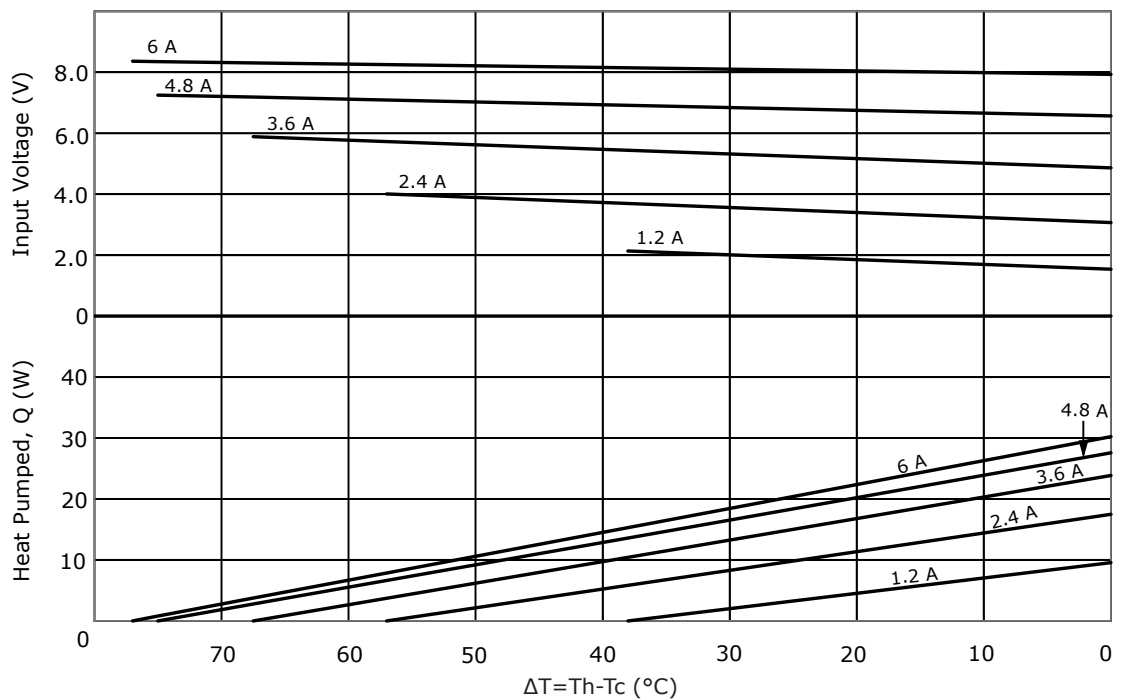

### CP60433H PERFORMANCE (Th=27°C)

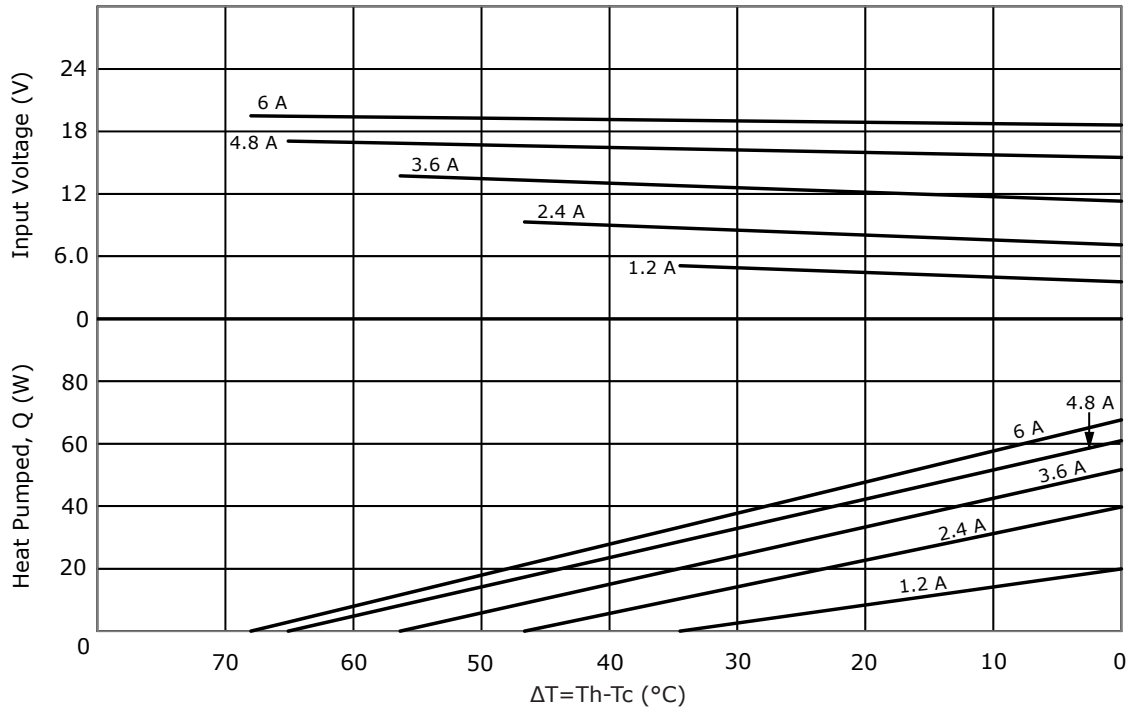

### CP60433H PERFORMANCE (Th=50°C)

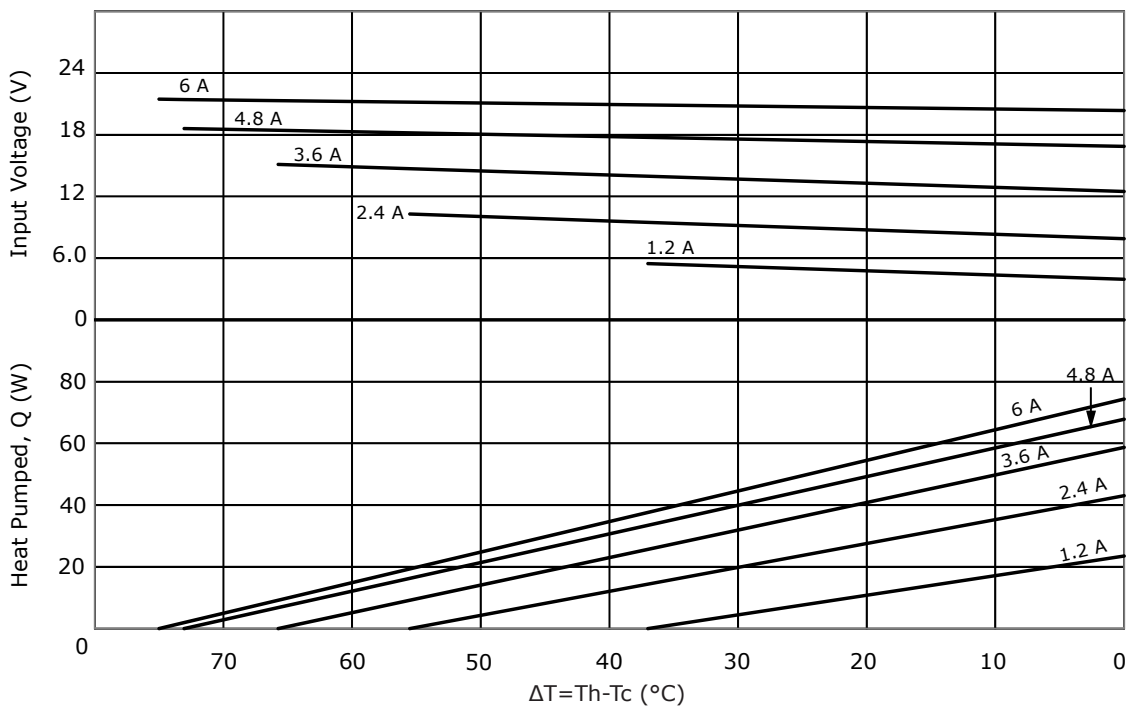

### CP604395H PERFORMANCE (Th=27°C)

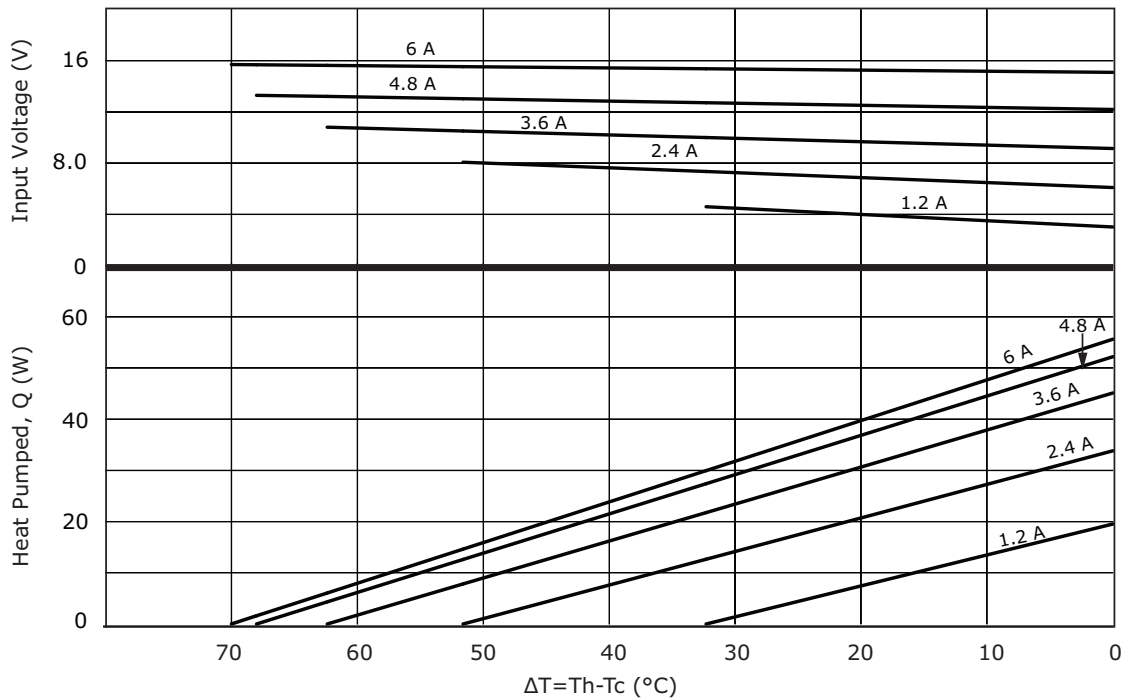

### CP604395H PERFORMANCE (Th=50°C)

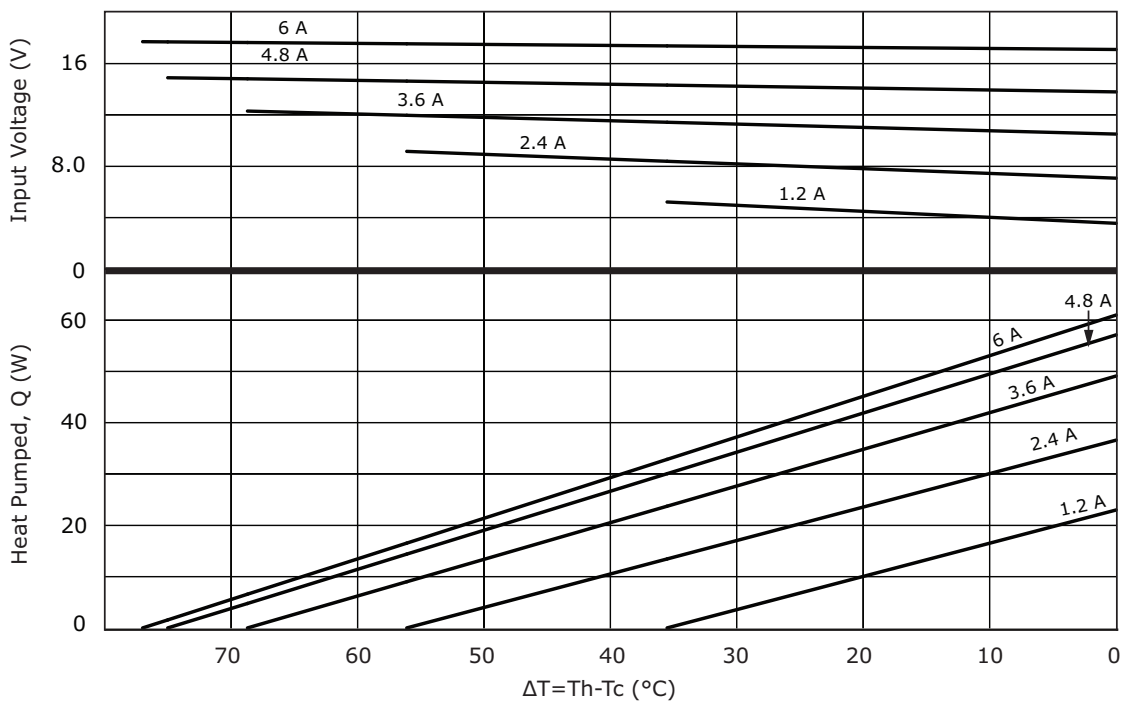

### CP604040 PERFORMANCE (Th=27°C)

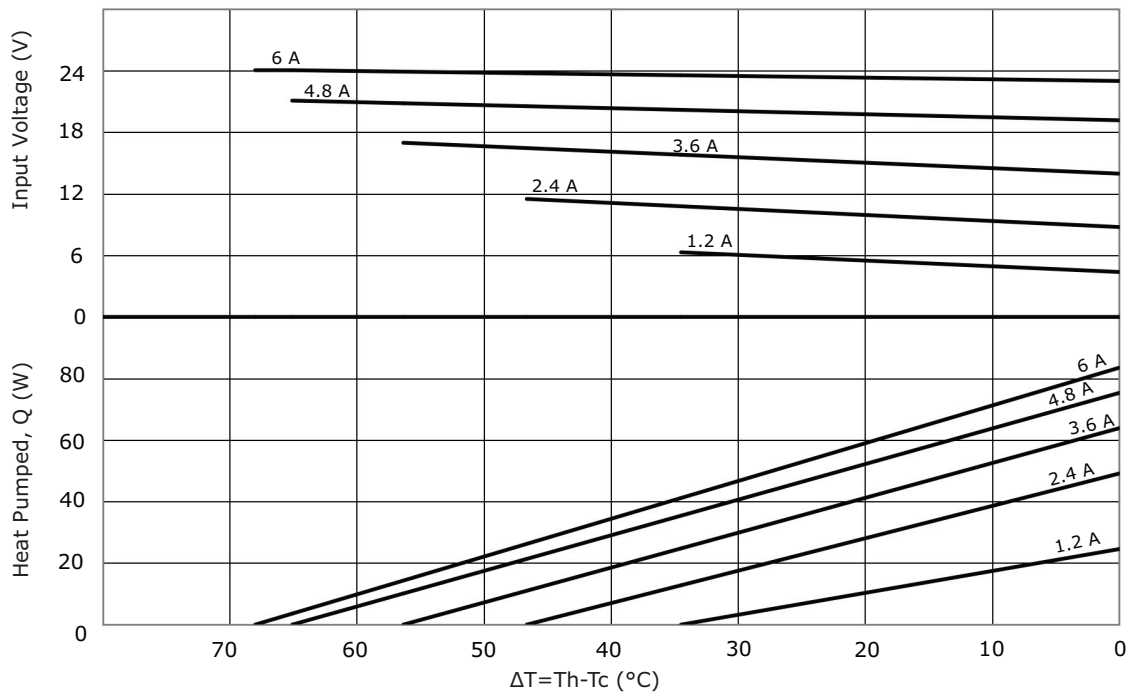

### CP604040 PERFORMANCE (Th=50°C)

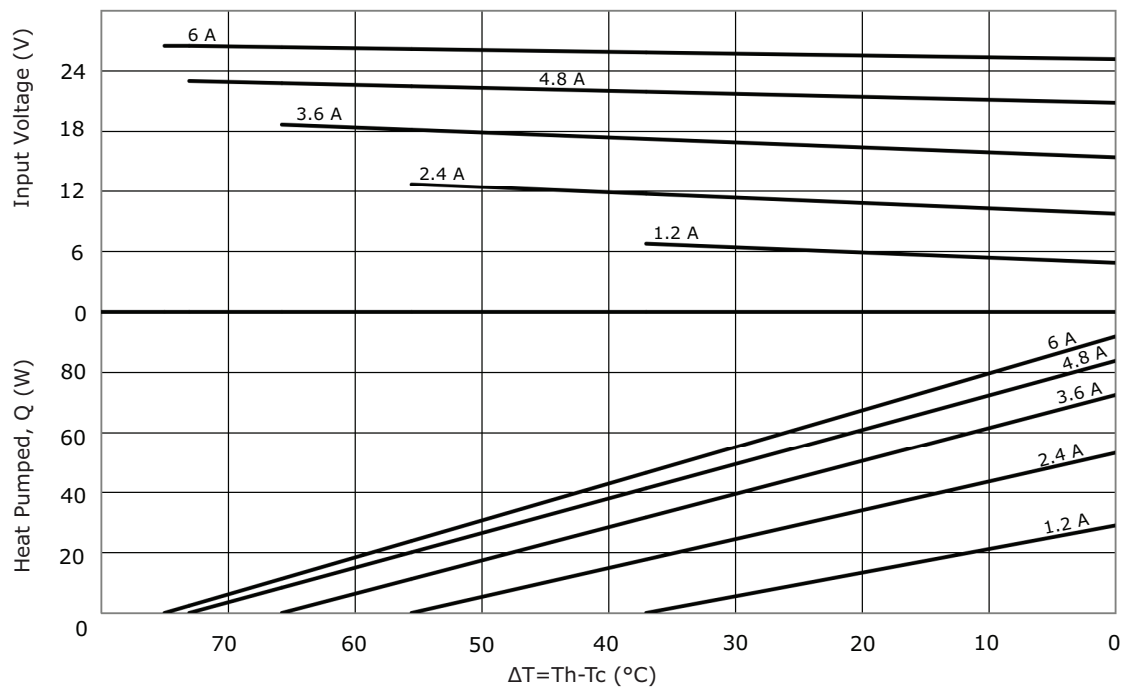



### CP60546241 PERFORMANCE (Th=27°C)

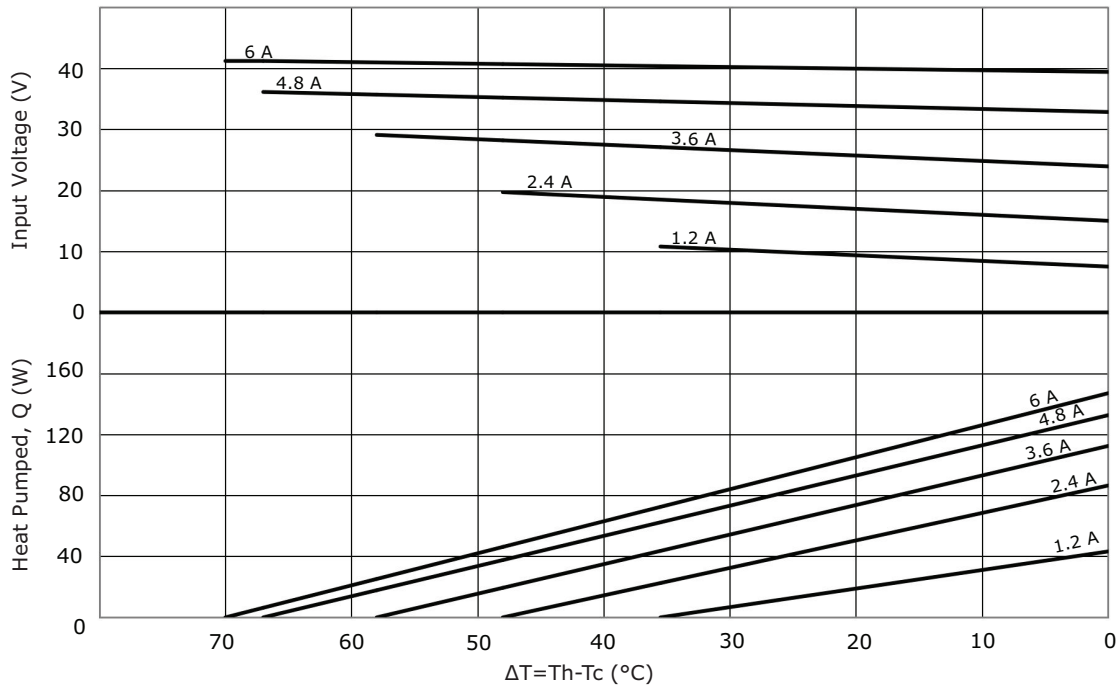

### CP60546241 PERFORMANCE (Th=50°C)

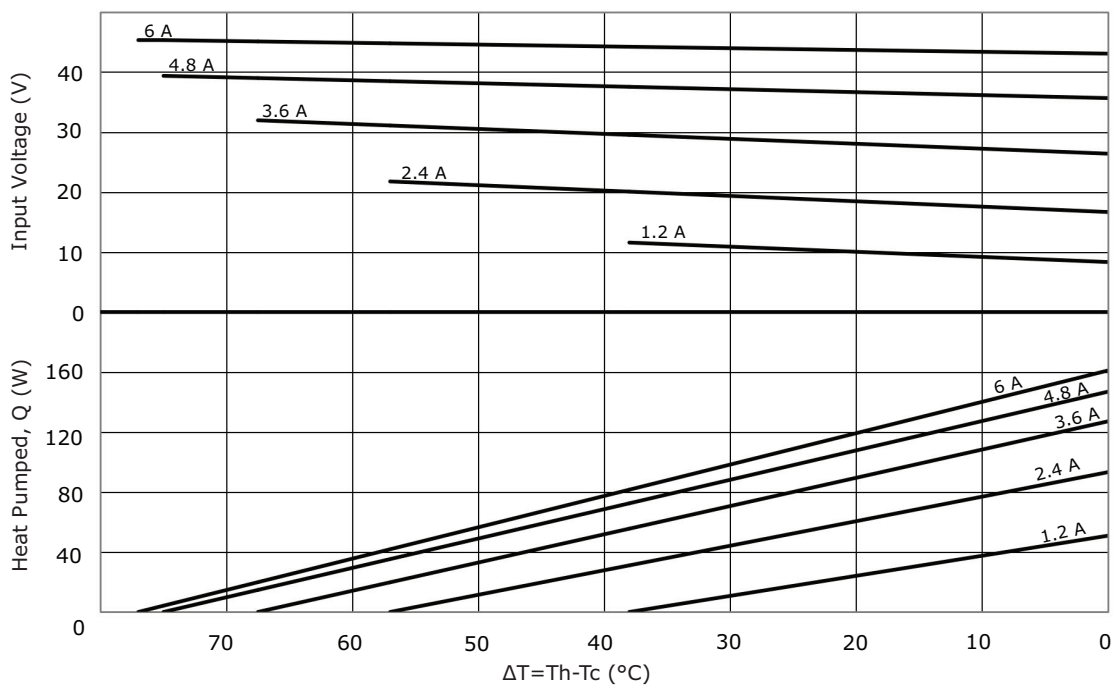

### CP6055354 PERFORMANCE (Th=27°C)

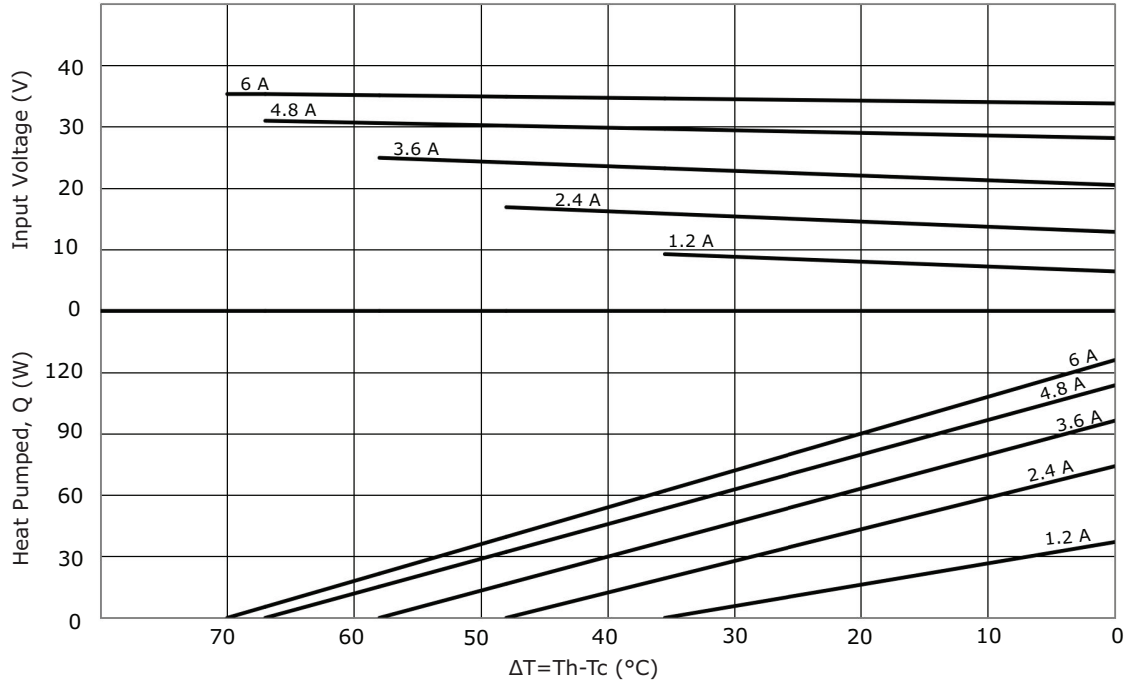

### CP6055354 PERFORMANCE (Th=50°C)

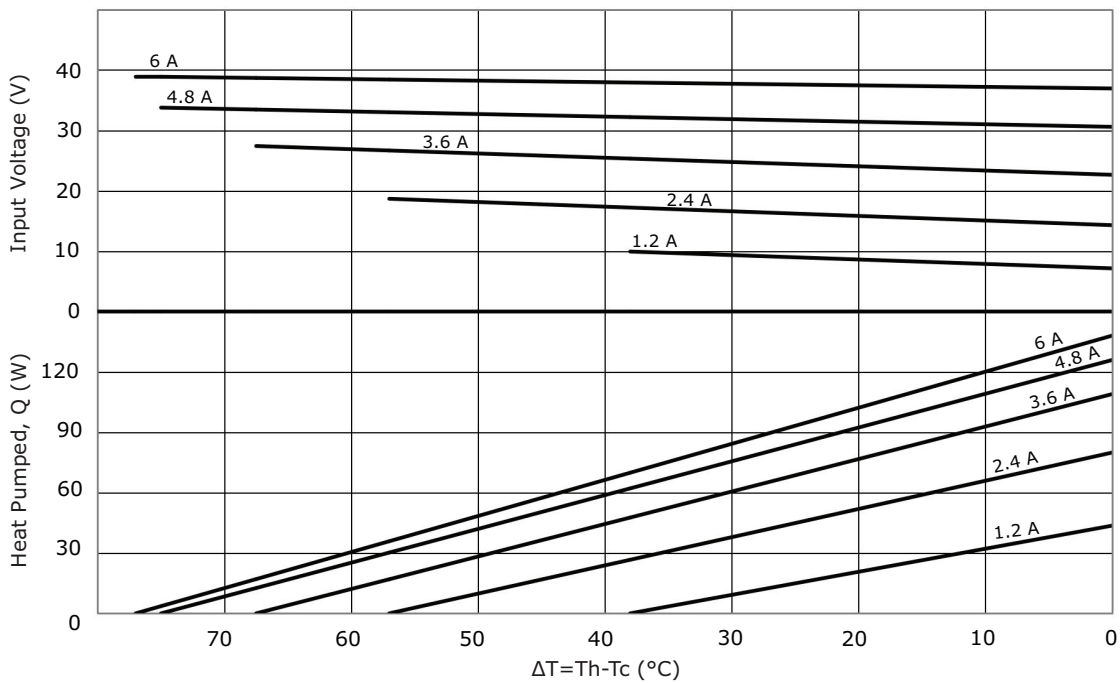

### CP6055542 PERFORMANCE (Th=27°C)

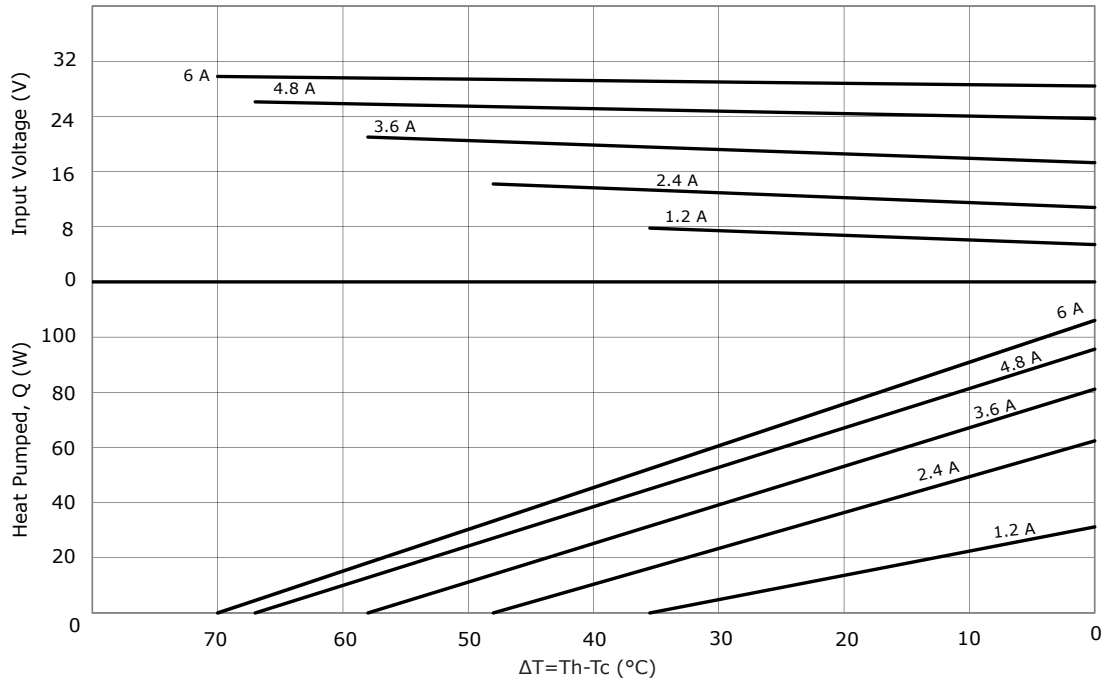

### CP6055542 PERFORMANCE (Th=50°C)

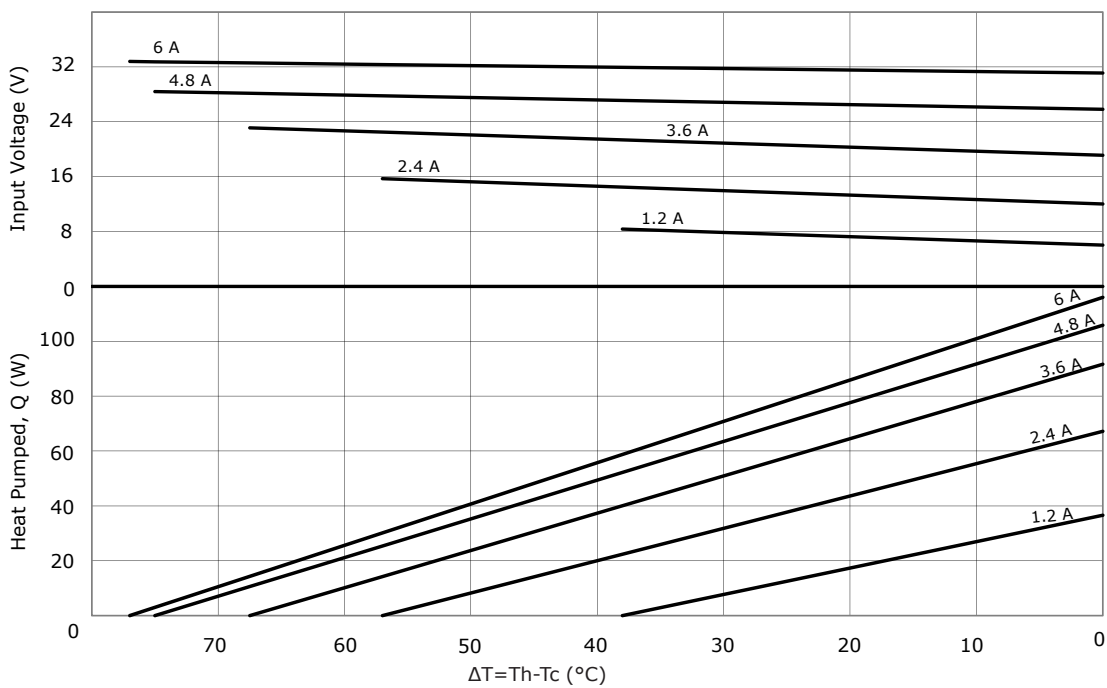

### CP604060395 PERFORMANCE (Th=27°C)

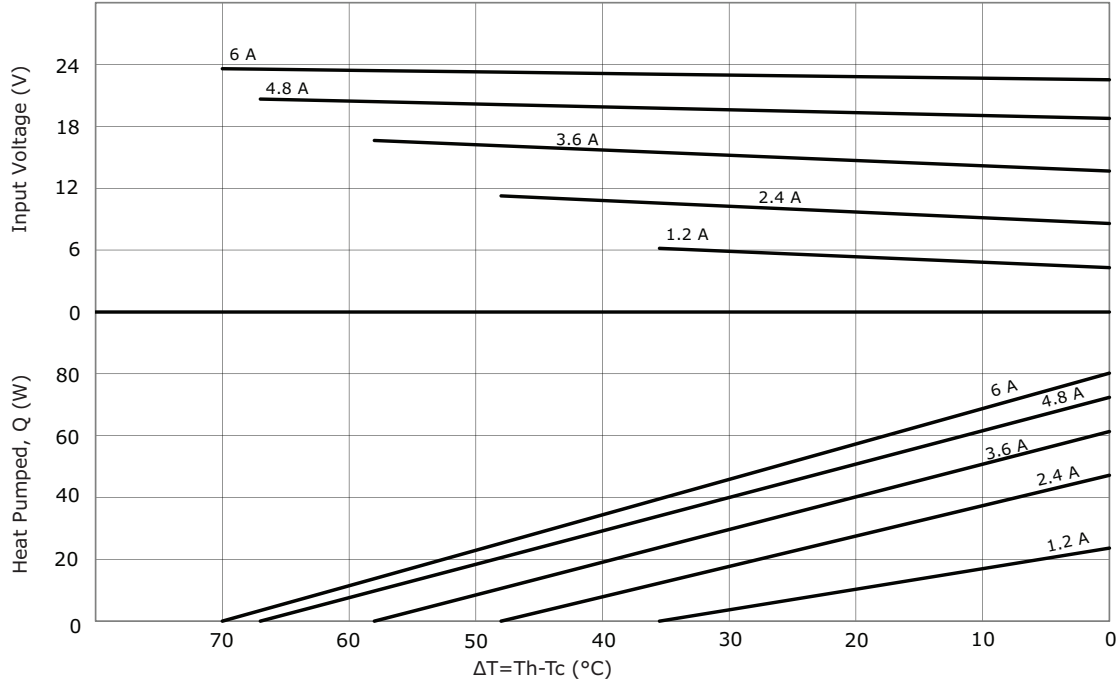

### CP604060395 PERFORMANCE (Th=50°C)

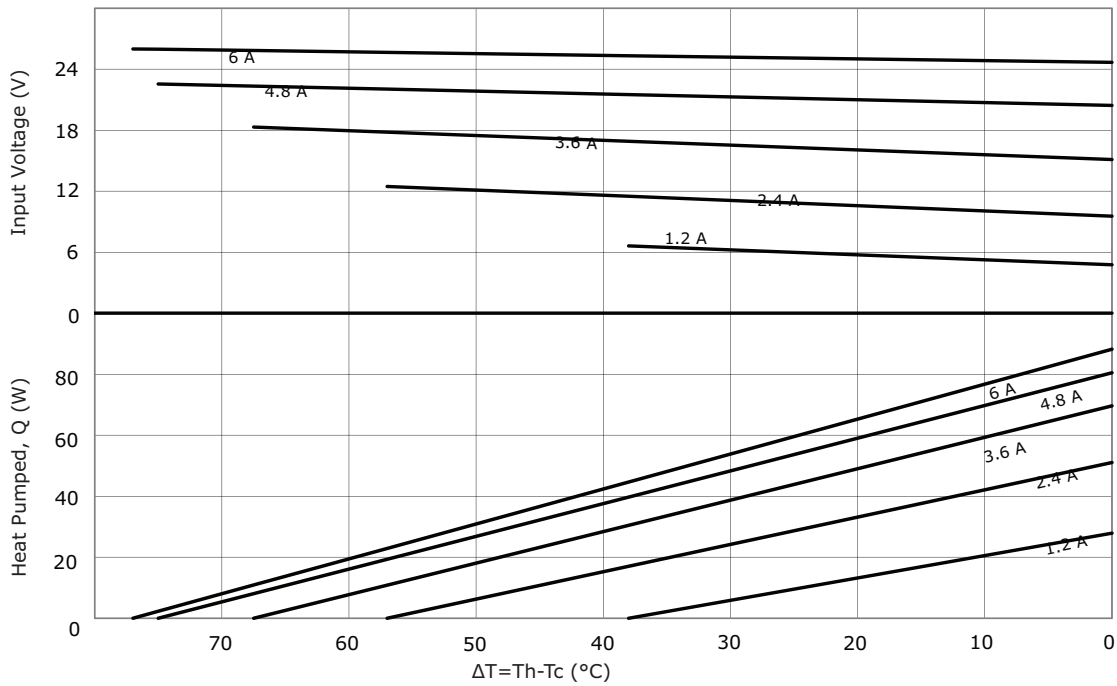

## REVISION HISTORY

---

rev.	description	date
1.0	initial release	09/08/2016
1.01	updated datasheet	09/25/2017
1.02	added new models	05/21/2018
1.03	added models CP604060395, CP60555542, CP6030395, CP604040, CP6055354, CP60546241, brand update	10/22/2019

The revision history provided is for informational purposes only and is believed to be accurate.

---

# CUI DEVICES

CUI Devices offers a one (1) year limited warranty. Complete warranty information is listed on our website.

CUI Devices reserves the right to make changes to the product at any time without notice. Information provided by CUI Devices is believed to be accurate and reliable. However, no responsibility is assumed by CUI Devices for its use, nor for any infringements of patents or other rights of third parties which may result from its use.

CUI Devices products are not authorized or warranted for use as critical components in equipment that requires an extremely high level of reliability. A critical component is any component of a life support device or system whose failure to perform can be reasonably expected to cause the failure of the life support device or system, or to affect its safety or effectiveness.