

## Dual Common Cathode diodes Power Module

**$V_{RRM} = 1700V$**   
 **$I_C = 400A @ T_c = 55^\circ C$**

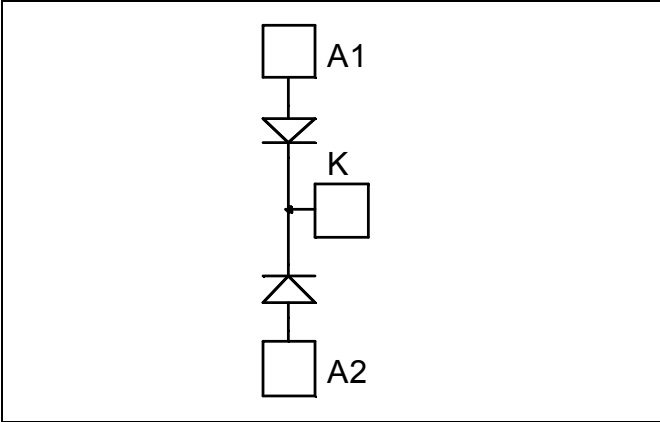

### Application

- Uninterruptible Power Supply (UPS)
- Induction heating
- Welding equipment
- High speed rectifiers

### Features

- Ultra fast recovery times
- Soft recovery characteristics
- High blocking voltage
- High current
- Low leakage current
- Very low stray inductance
  - Symmetrical design
  - M5 power connectors
- High level of integration

### Benefits

- Outstanding performance at high frequency operation
- Low losses
- Low noise switching
- Direct mounting to heatsink (isolated package)
- Low junction to case thermal resistance
- RoHS Compliant

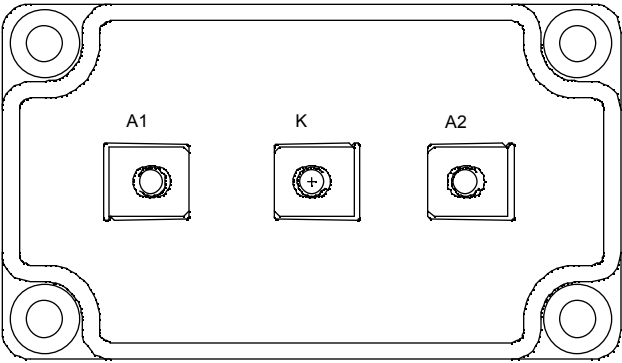

### Absolute maximum ratings

Symbol	Parameter	Max ratings	Unit	
$V_R$	Maximum DC reverse Voltage	1700	V	
$V_{RRM}$	Maximum Peak Repetitive Reverse Voltage			
$I_{F(AV)}$	Maximum Average Forward Current	Duty cycle = 50%	$T_c = 25^\circ C$	A
			$T_c = 55^\circ C$	
$I_{F(RMS)}$	RMS Forward Current	500		
$I_{FSM}$	Non-Repetitive Forward Surge Current	$T_j = 25^\circ C$	1500	

**CAUTION:** These Devices are sensitive to Electrostatic Discharge. Proper Handling Procedures Should Be Followed. See application note APT0502 on [www.microsemi.com](http://www.microsemi.com)



## Typical Performance Curve

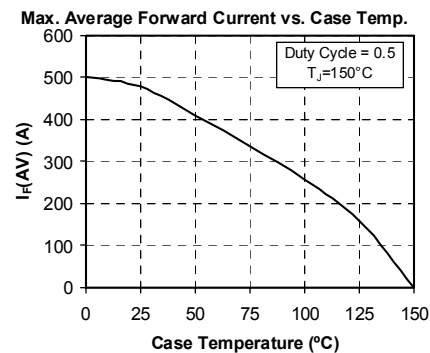
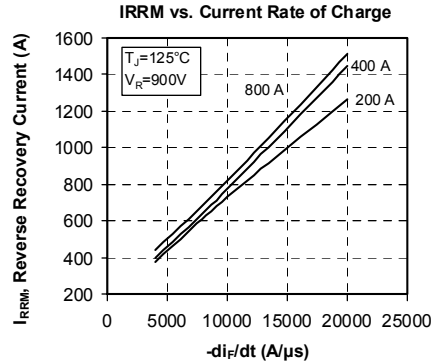
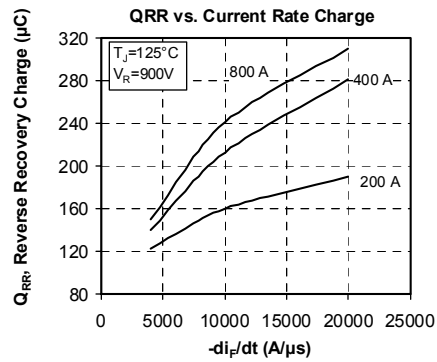
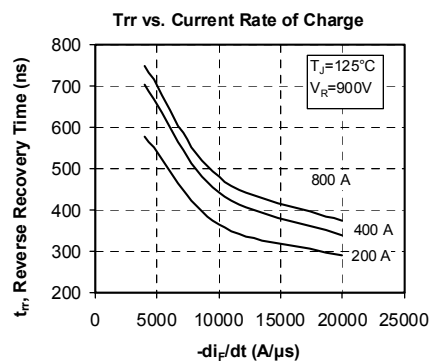
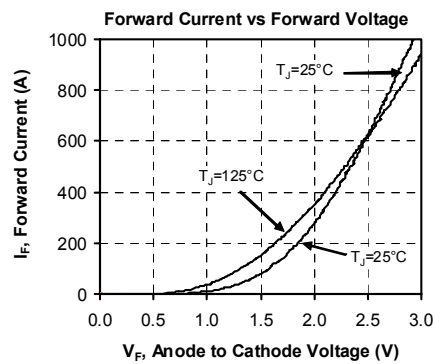
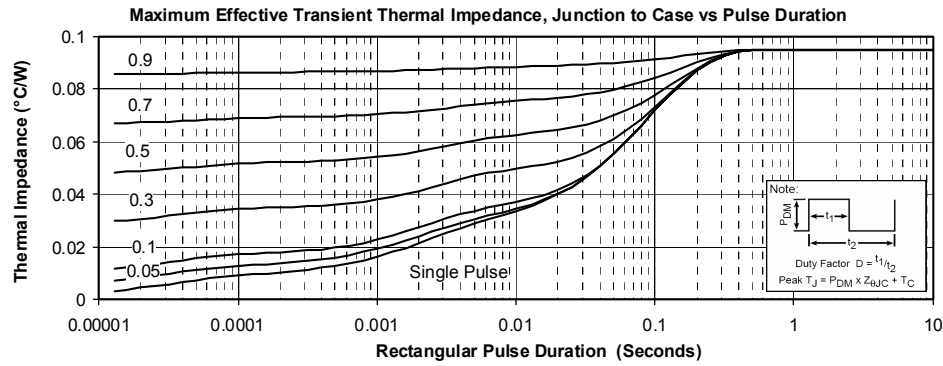

Microsemi reserves the right to change, without notice, the specifications and information contained herein

Microsemi's products are covered by one or more of U.S. patents 4,895,810 5,045,903 5,089,434 5,182,234 5,019,522 5,262,336 6,503,786 5,256,583 4,748,103 5,283,202 5,231,474 5,434,095 5,528,058 and foreign patents. U.S. and Foreign patents pending. All Rights Reserved.