

FEATURES

Ultralow SSB phase noise: -150 dBc/Hz typical
Single-ended input/outputs
RF output power: -2 dBm typical
Single-supply operation: 3 V
Ultrasmall, surface-mount, 2.90 mm \times 2.80 mm, 6-lead SOT-23 package

ENHANCED PRODUCT FEATURES

Supports defense and aerospace applications (AQEC standard)
Extended industrial temperature range: -55°C to $+105^{\circ}\text{C}$
Controlled manufacturing baseline
1 assembly/test site
1 fabrication site
Product change notification
Qualification data available upon request

APPLICATIONS

DC to C band PLL prescalers
Very small aperture terminal (VSAT) radios
Unlicensed national information infrastructure (UNII) and point to point radios
IEEE 802.11a and high performance radio local area network (HiperLAN) WLAN
Fiber optics
Cellular/3G infrastructure

GENERAL DESCRIPTION

The [HMC434-EP](#) is a low noise, static, divide by 8 prescaler monolithic microwave integrated circuit (MMIC) utilizing indium gallium phosphide/gallium arsenide (InGaP/GaAs) heterojunction bipolar transistor (HBT) technology in an ultrasmall surface-mount 6-lead SOT-23 package.

The [HMC434-EP](#) operates from near dc (square wave) or 0.2 GHz (sine wave) to 8 GHz input frequency with a single 3 V dc supply.

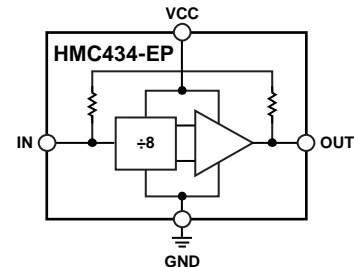
FUNCTIONAL BLOCK DIAGRAM*Figure 1.*

The [HMC434-EP](#) features single-ended inputs and outputs for reduced component count and cost. The low additive single sideband (SSB) phase noise of -150 dBc/Hz at 100 kHz offset helps the user maintain optimal system noise performance.

Additional application and technical information can be found in the [HMC434](#) data sheet.

TABLE OF CONTENTS

| | | | |
|---------------------------------|---|--------------------------------------------------|---|
| Features | 1 | Thermal Resistance | 4 |
| Enhanced Product Features | 1 | ESD Caution..... | 4 |
| Applications..... | 1 | Pin Configuration and Function Descriptions..... | 5 |
| Functional Block Diagram | 1 | Interface Schematics | 5 |
| General Description | 1 | Typical Performance Characteristics | 6 |
| Revision History | 2 | Outline Dimensions | 7 |
| Specifications..... | 3 | Ordering Guide | 7 |
| Absolute Maximum Ratings..... | 4 | | |

REVISION HISTORY

3/2019—Rev. A to Rev. B

| | |
|----------------------------|---|
| Changes to Figure 11 | 6 |
|----------------------------|---|

8/2017—Rev. 0 to Rev. A

| | |
|------------------------------------------------------------------|---|
| Changes to Features Section and General Description Section..... | 1 |
| Added Endnote 2 to Table 1 | 3 |

3/2017—Revision 0: Initial Version

SPECIFICATIONS

$V_{CC} = 3\text{ V}$, $T_A = 25^\circ\text{C}$, $50\ \Omega$ system, unless otherwise noted. P_{IN} is input power.

Table 1.

| Parameter | Min | Typ | Max | Unit | Test Conditions / Comments |
|----------------------------|------|------|------|--------|-------------------------------------------------------------------------|
| RADIO FREQUENCY (RF) INPUT | | | | | |
| Frequency ^{1,2} | 0.2 | | 8 | GHz | Sine wave input |
| Power | -10 | 0 | +10 | dBm | $f_{IN} = 1.0\text{ GHz to }3.0\text{ GHz}$ |
| | 0 | 0 | 10 | dBm | $f_{IN} = 3.0\text{ GHz to }8.0\text{ GHz}$ |
| RF OUTPUT | | | | | |
| SSB Phase Noise | | -150 | | dBc/Hz | 100 kHz offset, $P_{IN} = 0\text{ dBm}$, $f_{IN} = 4.0\text{ GHz}$ |
| Power | -5 | -2 | | dBm | $f_{IN} = 1.0\text{ GHz to }8.0\text{ GHz}$ |
| REVERSE LEAKAGE | | -25 | | dBm | $P_{IN} = 0\text{ dBm}$, $f_{IN} = 4.0\text{ GHz}$, output terminated |
| SUPPLY | | | | | |
| Voltage (V_{CC}) | 2.85 | 3 | 3.15 | V | |
| Current (I_{CC}) | | 62 | 83 | mA | |

¹ Below 200 MHz, a square wave input is required.

² For stable operation without an input signal, refer to the [AN-1463 Application Note](#), *Frequency Divider Operation and Compensation with No Input Signal*.

ABSOLUTE MAXIMUM RATINGS

Table 2.

| Parameter | Rating |
|---------------------------------------|------------------|
| Supply Voltage (V_{CC}) | -0.3 V to +3.5 V |
| RF Input Power ($V_{CC} = 3$ V) | 13 dBm |
| Temperature | |
| Operating | -55°C to +105°C |
| Storage | -65°C to +125°C |
| Junction, T_J | 135°C |
| Nominal ($T_A = 105^\circ\text{C}$) | 119°C |
| Reflow | 260°C |
| ESD Sensitivity | |
| Human Body Model (HBM) | Class 0 |

Stresses at or above those listed under Absolute Maximum Ratings may cause permanent damage to the product. This is a stress rating only; functional operation of the product at these or any other conditions above those indicated in the operational section of this specification is not implied. Operation beyond the maximum operating conditions for extended periods may affect product reliability.

THERMAL RESISTANCE

Thermal performance is directly linked to printed circuit board (PCB) design and operating environment. Careful attention to PCB thermal design is required.

θ_{JA} is the natural convection junction to ambient thermal resistance measured in a one cubic foot sealed enclosure. θ_{JC} is the junction to case thermal resistance.

Table 3. Thermal Resistance

| Package Type | θ_{JA} ¹ | θ_{JC} ² | Unit |
|--------------|----------------------------|----------------------------|------|
| RJ-6 | 359 | 70 | °C/W |

¹ Simulated values per JEDEC JESD51-12 standards.

² Junction to GND package pin.

ESD CAUTION



ESD (electrostatic discharge) sensitive device. Charged devices and circuit boards can discharge without detection. Although this product features patented or proprietary protection circuitry, damage may occur on devices subjected to high energy ESD. Therefore, proper ESD precautions should be taken to avoid performance degradation or loss of functionality.

PIN CONFIGURATION AND FUNCTION DESCRIPTIONS

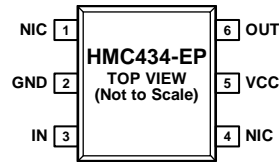

NOTES
 1. NOT INTERNALLY CONNECTED. THESE PINS CAN BE CONNECTED TO RF AND DC GROUND WITHOUT AFFECTING PERFORMANCE. THE NIC PINS ARE TYPICALLY TIED TO GND FOR ENHANCED THERMAL PERFORMANCE (BUT NOT REQUIRED).

15647-002

Figure 2. Pin Configuration

Table 4. Pin Function Descriptions

| Pin No. | Mnemonic | Description |
|---------|----------|------------------------------------------------------------------------------------------------------------------------------------------------------------------------------------------------------|
| 1, 4 | NIC | Not Internally Connected. These pins can be connected to RF and dc ground without affecting performance. The NIC pins are typically tied to GND for enhanced thermal performance (but not required). |
| 2 | GND | Ground. This pin must be connected to both RF and dc ground. |
| 3 | IN | RF Input. This pin must be dc blocked. |
| 5 | VCC | Supply Voltage (3 V). |
| 6 | OUT | RF Output. This pin must be dc blocked. |

INTERFACE SCHEMATICS



Figure 3. GND Interface Schematic

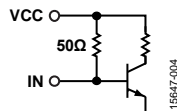

Figure 4. IN Interface Schematic

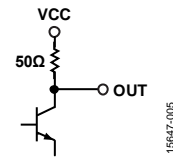

Figure 5. OUT Interface Schematic

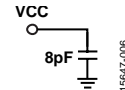

Figure 6. VCC Interface Schematic

TYPICAL PERFORMANCE CHARACTERISTICS

In Figure 9, $P_{FEEDTHROUGH}$ is the power of the output spectrum at the input frequency.

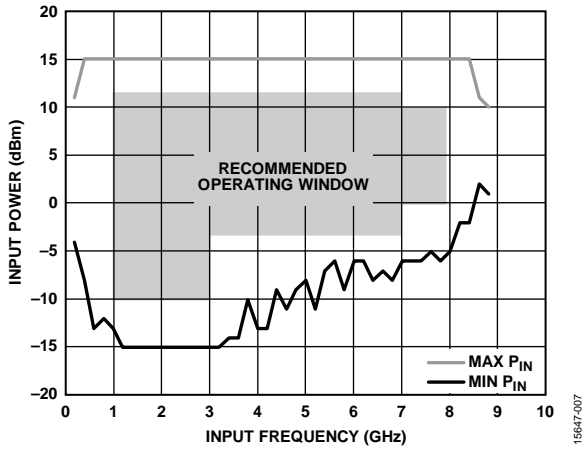

Figure 7. Input Sensitivity Window

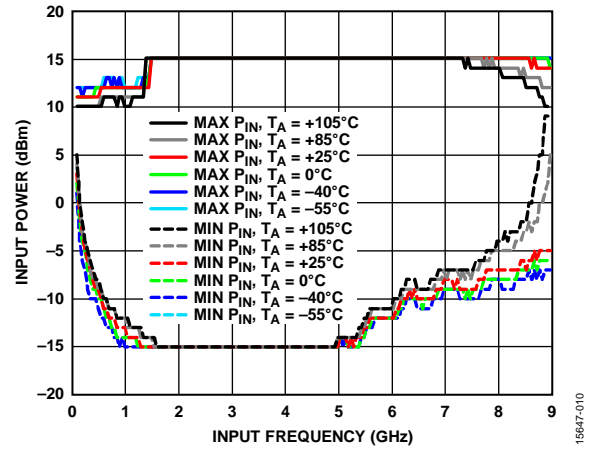

Figure 10. Input Sensitivity Window at Various Temperatures

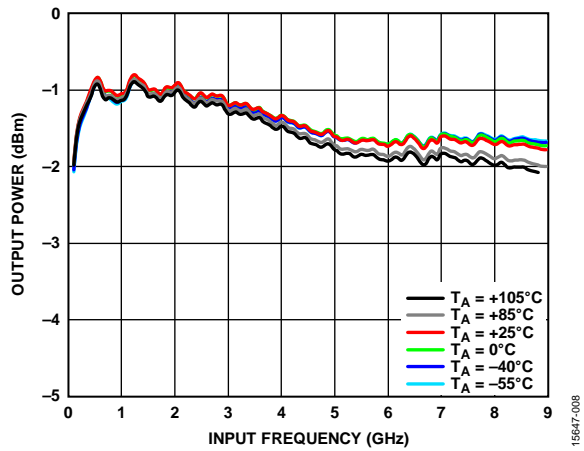

Figure 8. Output Power vs. Frequency at Various Temperatures

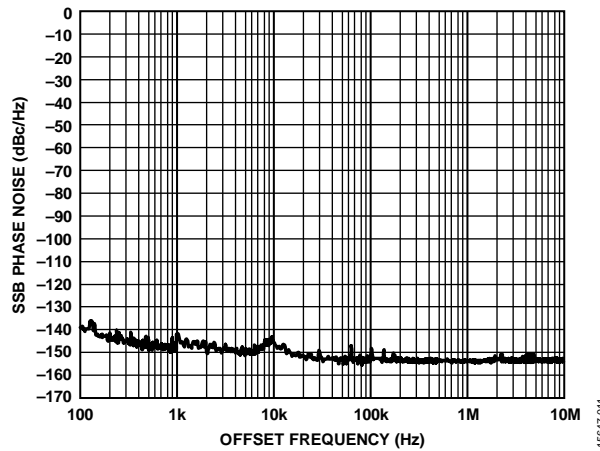

Figure 11. SSB Phase Noise ($P_{IN} = 0$ dBm)

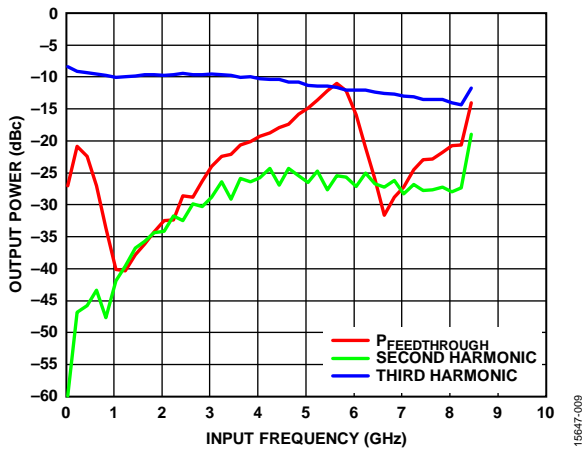

Figure 9. Output Harmonic Content ($P_{IN} = 0$ dBm)

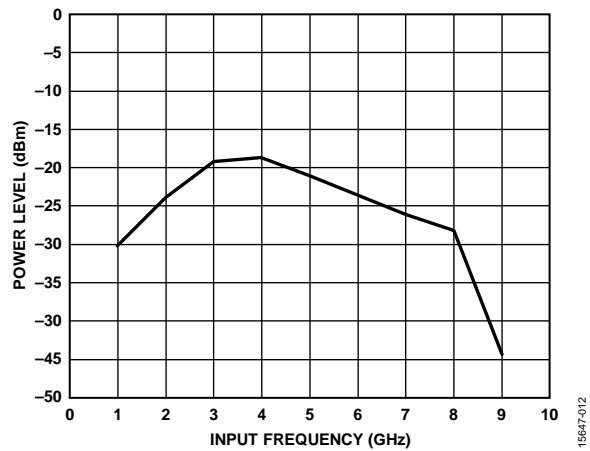
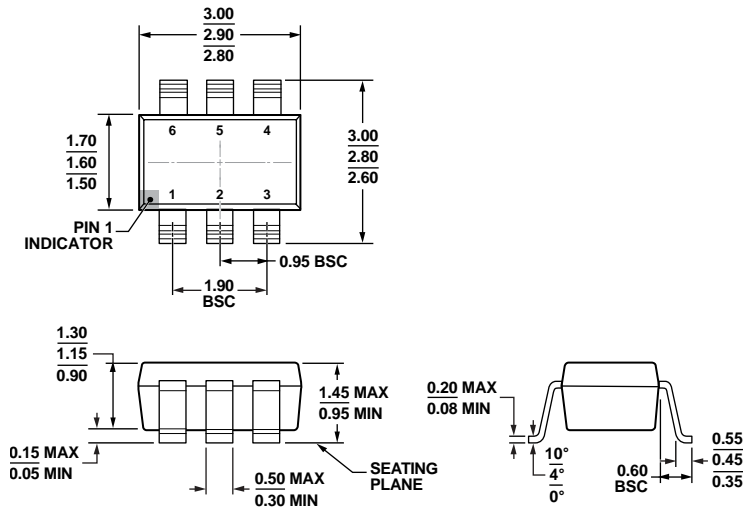

Figure 12. Reverse Leakage ($P_{IN} = 0$ dBm)

OUTLINE DIMENSIONS



COMPLIANT TO JEDEC STANDARDS MO-178-AB

Figure 13. 6-Lead Small Outline Transistor Package [SOT-23] (RJ-6)

Dimensions shown in millimeters

12-16-2008-A

ORDERING GUIDE

| Model ¹ | Temperature Range | Package Description | Package Option | Marking Code |
|--------------------|-------------------|--------------------------------------------------|----------------|--------------|
| HMC434SRJZ-EP-PT | -55°C to +105°C | 6-Lead Small Outline Transistor Package [SOT-23] | RJ-6 | 34P |
| HMC434SRJZ-EP-R7 | -55°C to +105°C | 6-Lead Small Outline Transistor Package [SOT-23] | RJ-6 | 34P |

¹ Z = RoHs Compliant Part.