

Xinger®

Delay Line

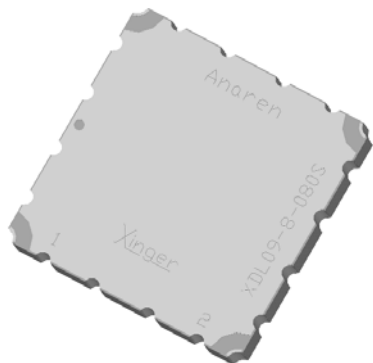

DESCRIPTION

The XDL09-8-080 is a surface mount delay line that uses a slow wave coupling structure that maximizes the amount of delay per unit area over other distributed delay structures. The XDL09-8-080 can be used in amplifier linearization applications from 869 – 960MHz. The XDL09-8-080 is ideal for use in the main loop of feed forward and in pre-distortion amplifiers. The Xinger® delay lines are a low cost, high quality alternative to the traditional coaxial and filter solutions presently available. Parts have been subjected to rigorous qualification testing and units are 100% tested. Available in 6 of 6 tin immersion (XDL09-8-080S) RoHS compliant finishes.

Features:

- Production Friendly
- Consistent Delay
- Stable Over Temperature
- Surface Mountable
- Available in Tape & Reel
- Non-Lead Solder Paste Compatible
- Available in Lead-Free as illustrated) or Tin-Lead
- 100% Tested

ELECTRICAL SPECIFICATIONS

Frequency (MHz.)	869-894 AMPS Band	925-960 GSM Band
Mean Delay (ns)	8.04 ± 0.18	8.22 ± 0.18
Deviation from Linear Phase (Degrees Max)	± 1.0	± 1.0
Amplitude Flatness (dB p-p)	0.10	0.15
Return Loss (dB min)	20	20
Insertion Loss (dB/NS)	0.45	0.45
Power Handling (Watts)	1	1
ΘJC (°C/watts)	5	5
Operating Temp. (°C)	-55 to +85	-55 to +85

Specification based on performance of unit properly installed on microstrip printed circuit boards with 50 Ω nominal impedance. Specifications subject to change without notice.

OUTLINE DRAWING

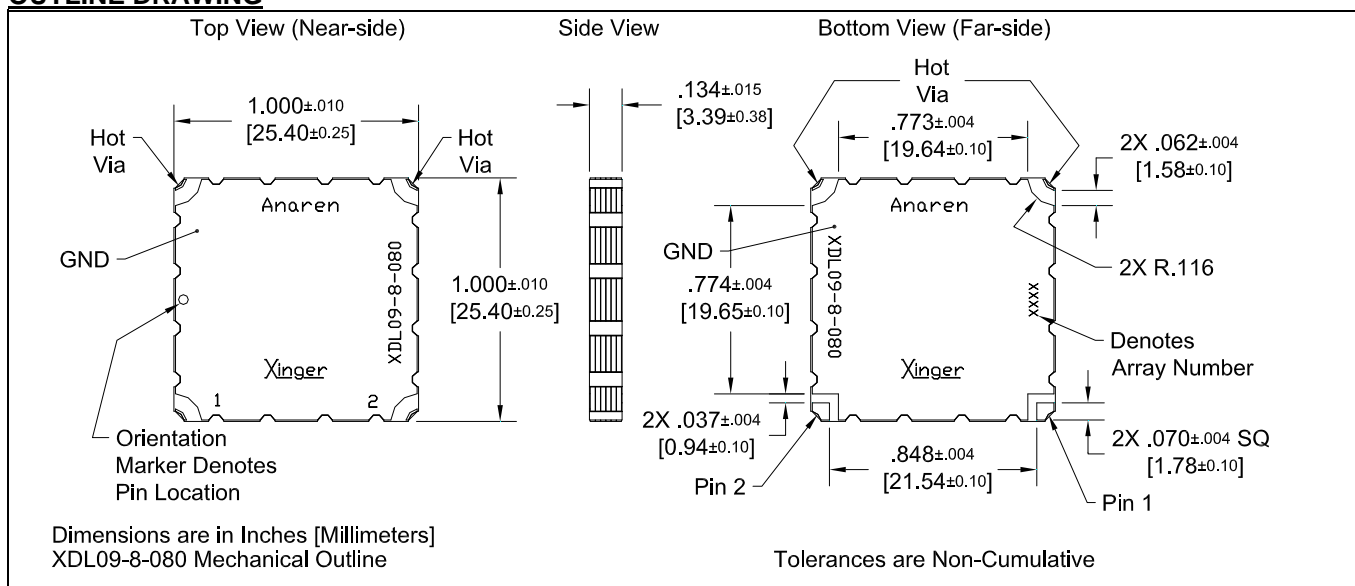

TYPICAL PERFORMANCE: 500 MHz. To 2500 MHz.

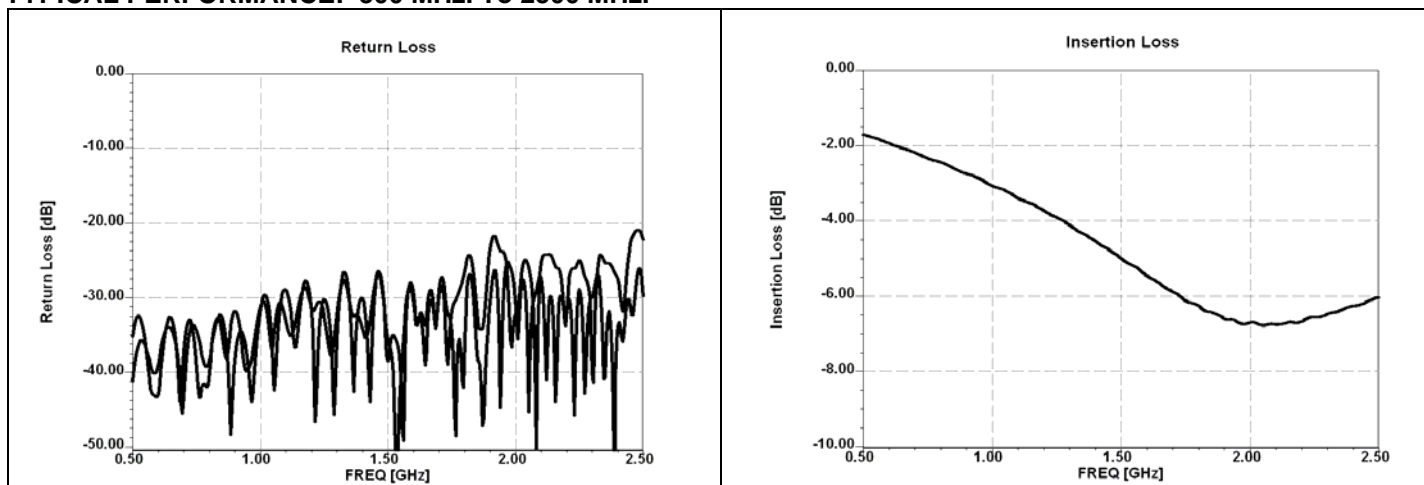

AVERAGE DELAY

The average delay is defined as the group delay of the input signal through the delay line. Because the Xinger delay lines take advantage of a narrow band tuning technique, the average delay over the broad band varies. Because the XDL09-8-080 is tuned at 2.0GHz, the average delay in that range is larger than at 1.0 GHz and specifications reflect this variation. The lot-to-lot variation is reflected in the plus/minus tolerance given in specifications.

Refer to Anaren Application Note AAN-232 for further information on Xinger delay lines.

MOUNTING GUIDELINES:

there must be a ground plane with 100% solder connection underneath the part

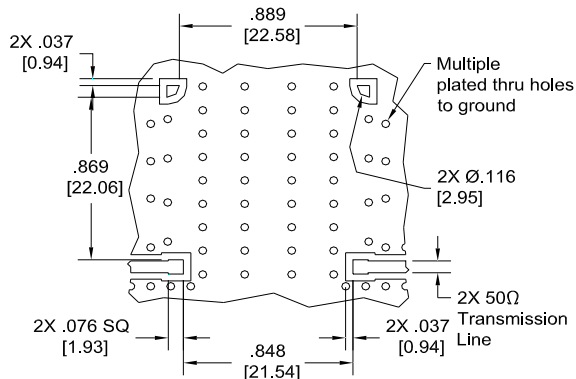
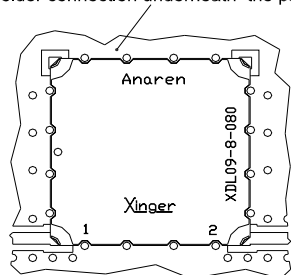

Dimensions are in Inches [Millimeters]
XDL09-8-080 Mounting Footprint

In order for Xinger surface mount delay lines to work optimally, there must be 50Ω transmission lines leading to and from all of the RF ports. Also, there must be a very good ground plane under the part with a number of plated thru holes to ensure proper electrical performance. If any of these conditions are not satisfied, insertion loss, average delay and VSWR may not meet published specifications.

When a surface mount delay line is mounted to a printed circuit board (PCB), the primary concerns are; insuring the RF pads of the device are in contact with the circuit trace of the PCB and the ground plane of neither the component nor the PCB are in contact with the RF signal. An example of how the PCB footprint could look is shown below. In particular designs, the 50Ω lines need to be adjusted to the unique dielectric coefficients and thicknesses as well as varying pick and place equipment tolerances.





Packaging and ordering Information

Parts are available in both reel and tube. Packaging follows EIA 481-2. Parts are oriented in tape and reel as shown below. Minimum order quantities are 250 per reel and 19 per tube.

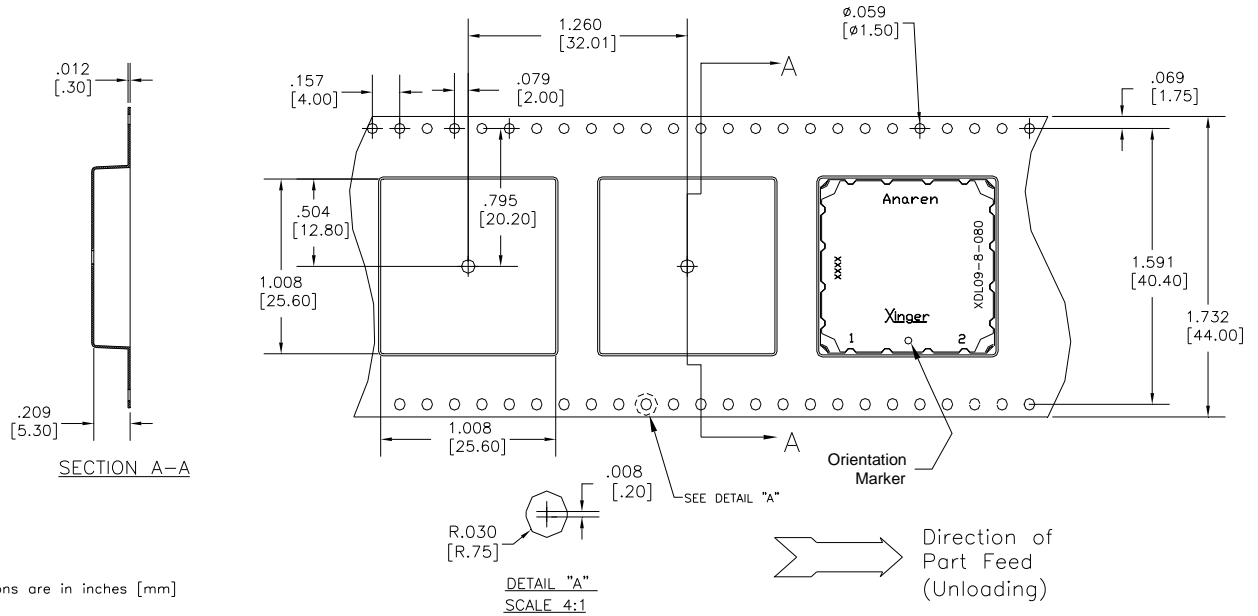

Reel

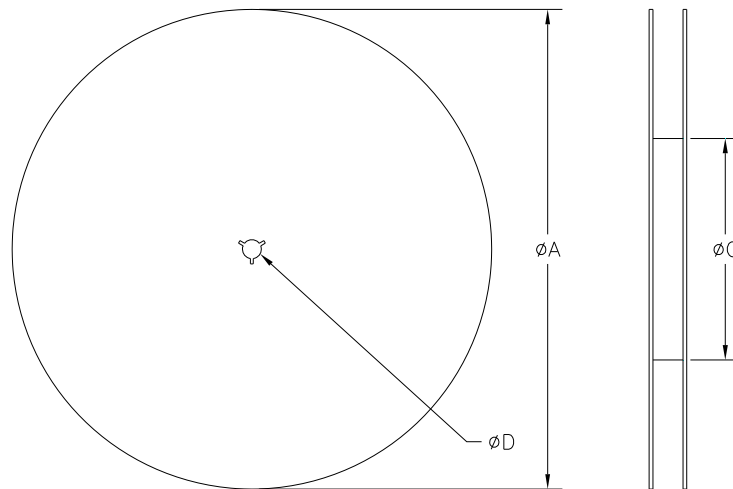

TABLE 1	
REEL DIMENSIONS (inches [mm])	
øA	13.3 [333.0]
B	1.732 [44.0]
øC	4.017 [102.03]
øD	0.512 [13.0]

