

DIO20881/1D/2/4

600nA, Rail-to-Rail Input/ Output Low Power Amplifier

Features

- Ultra low power: 600nA per channel
- Unity Gain Stable
- Gain Bandwidth Product: 14kHz
- Wide supply range: 1.4V to 5.5V
- Available in SOT23-5, SOT23-6, SOIC-8, MSOP-8, SOP-14 and TSSOP-14 packages
- Temperature Range:
 - Industrial: -40°C to +85°C
 - Extended: -40°C to +125°C

Typical Applications

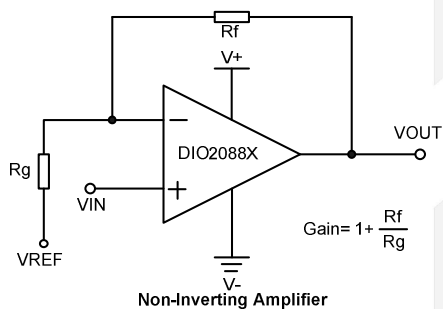

Descriptions

DIO2088x is a family of ultra low power operational amplifier, with rail-to-rail CMOS input/output and single/dual channels selectable. DIO2088x family has a gain-bandwidth product of 14kHz, wide operating supply voltage from 1.4V to 5.5V and broad output voltage swing.

DIO2088x consumes ultra low power, with each channel 600nA of bias current, which makes DIO2088x be ideal for battery powered device, temperature-sense device, etc.

The DIO2088x operational amplifier family is available in single (DIO20881/1D), and dual (DIO20882), and quad (DIO20884) configurations. Furthermore, the DIO20881 is offered in the 5-lead SOT23 package. All types of amplifiers are fully specified over the extended -40°C to +125°C temperature range.

Applications

- Portable Equipment
- Active Filters
- Data Acquisition
- Portable Equipment
- Test Equipment
- Broadband Communication
- Process Control
- Audio and Video Processing

Ordering Information

Order Part Number	Top Marking		T _A	Package	
DIO20881ST5	YW(X)Z	Green or RoHS	-40 to +125°C	SOT23-5	Tape & Reel, 3000
DIO20881SO8	DIO2081	Green or RoHS	-40 to +125°C	SOIC-8	Tape & Reel, 2500
DIO20881MP8	DIO2081	Green or RoHS	-40 to +125°C	MSOP-8	Tape & Reel, 3000
DIO20881DST6	YWDL	Green or RoHS	-40 to +125°C	SOT23-6	Tape & Reel, 3000
DIO20881DSO8	D20881D	Green or RoHS	-40 to +125°C	SOIC-8	Tape & Reel, 2500
DIO20881DMP8	D20881D	Green or RoHS	-40 to +125°C	MSOP-8	Tape & Reel, 3000
DIO20882SO8	DIO2082	Green or RoHS	-40 to +125°C	SOIC-8	Tape & Reel, 2500
DIO20882MP8	DIO2082	Green or RoHS	-40 to +125°C	MSOP-8	Tape & Reel, 3000
DIO20884CS14	DIO2084	Green or RoHS	-40 to +125°C	SOP-14	Tape & Reel, 2500
DIO20884TP14	DIO2084	Green or RoHS	-40 to +125°C	TSSOP-14	Tape & Reel, 2500

Pin Assignments

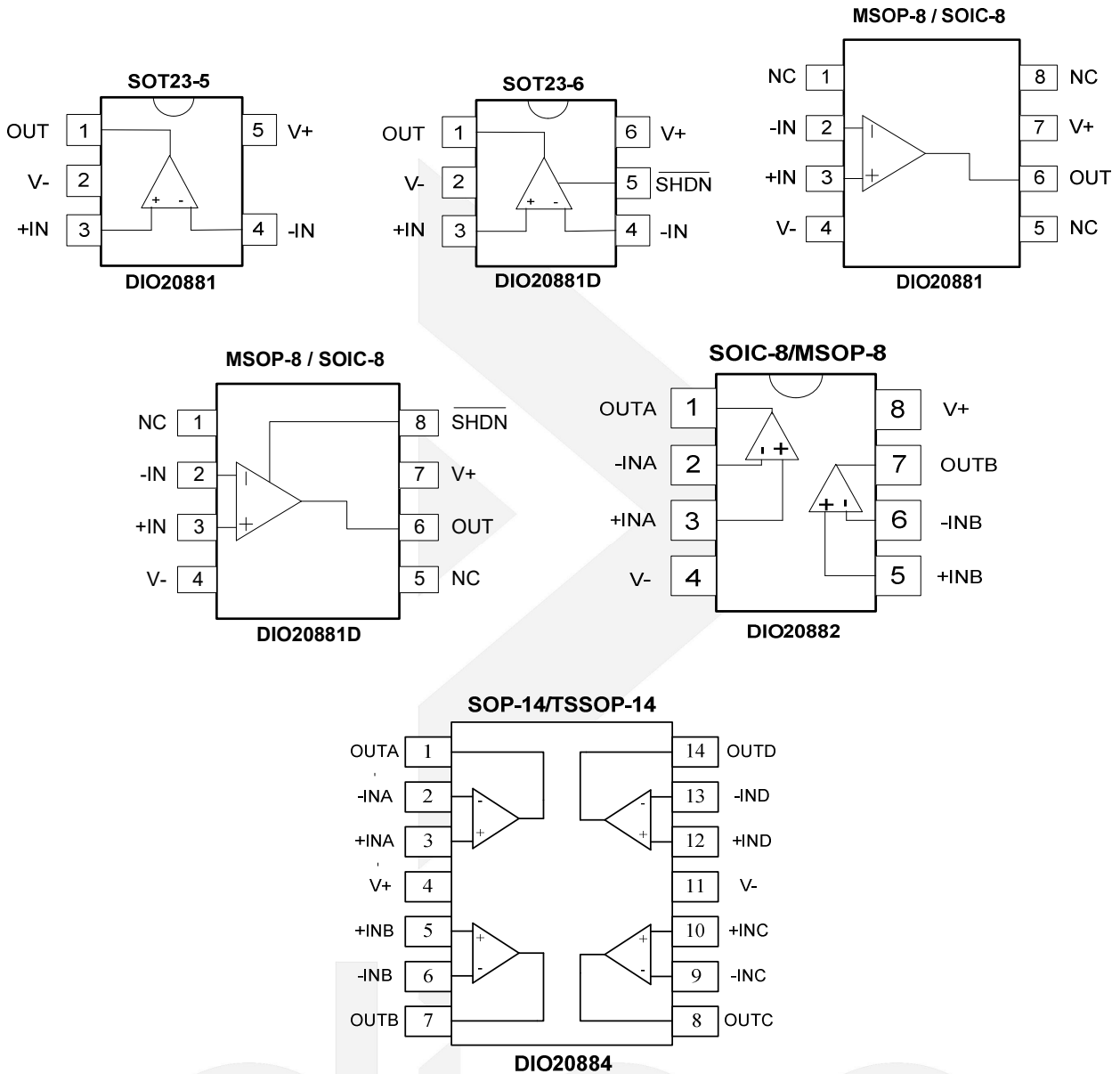

Figure 1 Top View

Pin Description

Pin name	Description
V+	Positive supply
V-	Negative supply
+INX	Positive Input
-INX	Negative Input
OUTX	Output
SHDN	Active Low Shutdown

Absolute Maximum Ratings

Stresses beyond those listed under “Absolute Maximum Rating” may cause permanent damage to the device. These are stress ratings only and functional operation of the device at these or any other condition beyond those indicated in the operational sections of the specifications is not implied. Exposure to absolute maximum rating conditions for extended periods may affect device reliability.

Parameter		Rating	Unit
Supply Voltage (V+ – V-)		7	V
Input Voltage		(V-)-0.3V to (V+)+0.3V	V
Difference Input Voltage		V+ – V-	V
Storage Temperature Range		-65 to 150	°C
Junction Temperature		150	°C
Lead Temperature Range		260	°C
ESD	HBM, JEDEC: JESD22-A114	8	kV
	CDM, JEDEC: JESD22-C101	2	

Recommended Operating Conditions

The Recommended Operating Conditions table defines the conditions for actual device operation to ensure optimal performance to the datasheet specifications. DIOO does not recommend exceeding them or designing to Absolute Maximum Ratings.

Parameter		Rating	Unit
Supply Voltage		1.4 to 5.5	V
Input Voltage		0 to 5	V
Operating Temperature Range		-40 to 125	°C



Electrical Characteristics

Typical value: $V_{+}=5V$, $R_L=1M\Omega$ to $V_{+}/2$, $V_{CM}=1/2V_{+}$, $T_A = 25^{\circ}C$, unless otherwise specified.

Symbol	Parameter	Conditions	Min.	Typ.	Max.	Unit
INPUT CHARACTERISTICS						
V_{OS}	Input Offset Voltage	$-40^{\circ}C \leq T_A \leq 125^{\circ}C$, $V_{+}=1.4V$ to $5.5V$	-2		+2	mV
I_B	Input Bias Current	$V_{+}=1.4V$ to $5.5V$		1		pA
I_{OS}	Input Offset Current	$V_{+}=1.4V$ to $5.5V$		1		pA
V_{CM}	Common Mode Voltage Range		-0.1		(V_{+}) +0.1	V
CMRR	Common Mode Rejection Ratio	$-40^{\circ}C \leq T_A \leq 125^{\circ}C$,	100			dB
A_{OL}	Open Loop Voltage Gain	$R_L=50k\Omega$, $V_O=0.1$ to $(V_{+})-0.1$	70	87		dB
$\Delta V_{OS}/\Delta T$	Input Offset Voltage Drift	$-40^{\circ}C \leq T_A \leq 125^{\circ}C$		± 5		$\mu V/^{\circ}C$
OUTPUT CHARACTERISTICS						
V_{OH}	Output Voltage High	$R_L=50k\Omega$ $-40^{\circ}C \leq T_A \leq 125^{\circ}C$		4.992		V
V_{OL}	Output Voltage Low	$R_L=50k\Omega$ $-40^{\circ}C \leq T_A \leq 125^{\circ}C$		8	15	mV
I_{SC}	Output Short Circuit Current	Source I_{SC} , $V_{+}=5V$		30		mA
		Sink I_{SC} , $V_{+}=5V$		30		
POWER SUPPLY						
PSRR	Power Supply Rejection Ration		100			dB
I_Q	Supply Current per Channel/Amp	$-40^{\circ}C \leq T_A \leq 125^{\circ}C$		600	1000	nA
$I_{Q(off)}$	Supply Current in Shutdown	$V_{SHDN}=0V$		3		nA
I_{SHDN}	Shutdown Pin Current			-10		pA
I_{LEAK}	Output Leakage Current in Shutdown	$V_{SHDN}=0V$		3.6		pA
V_{IL}	SHDN Input Low Voltage	Disable			0.5	V
V_{IH}	SHDN Input High Voltage	Enable	1.1			V
DYNAMIC PERFORMANCE						
GBP	Gain Bandwidth Product	$C_L=60pF$		14		kHz
SR	Slew Rate	$G=1$, 2V Output Step		3.5		V/ms
t_s	Setting Time	$G=1$, 2V Output Step		150		μs
Θ_m	Phase Margin			49		Deg
t_r	Overload Recovery Time			110		μs
NOISE PERFORMANCE						
THD	Total Harmonic Distortion	$f=100Hz$, $4V_{PP}$, $R_L=50k\Omega$,		0.09		%
e_n	Voltage Noise Density	$f=1kHz$		190		nV/\sqrt{Hz}

Specifications subject to change without notice.

Typical Performance Characteristics

Supply Current vs. Supply Voltage

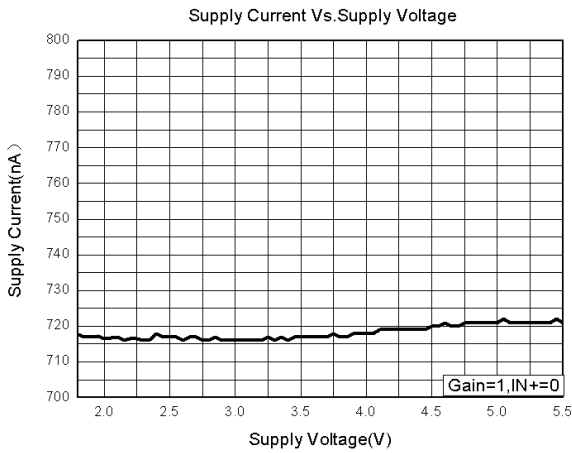

Supply Current vs. Temperature

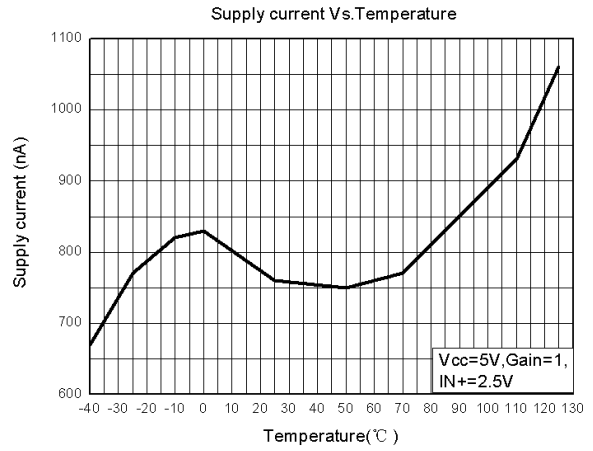

I_{SOURCE} vs. Output Voltage

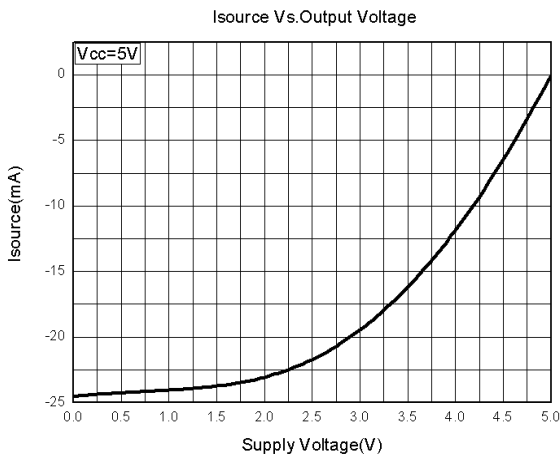

I_{SINK} vs. Output Voltage

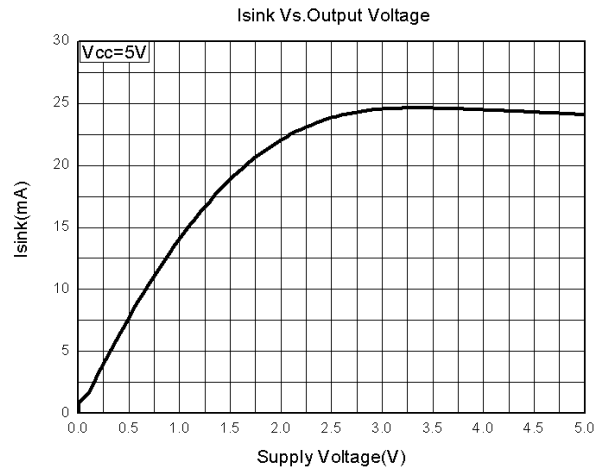

Gain vs. Frequency

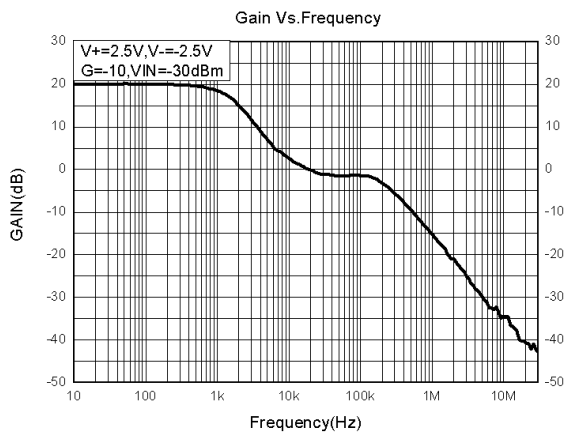

Input Offset Voltage vs. Temperature

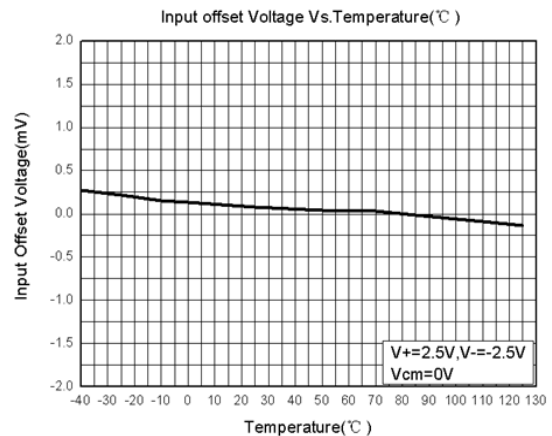

Input Offset Voltage vs. Supply Voltage

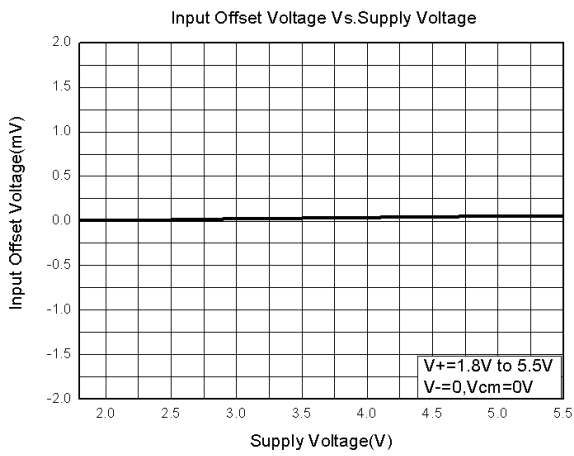

Input Offset Voltage vs. Common Voltage

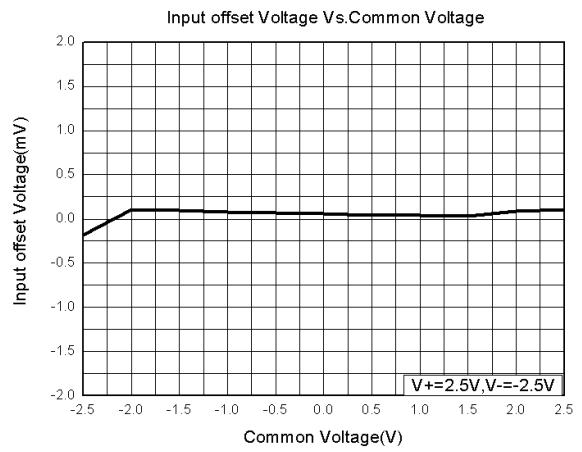

Physical Dimensions: SOT23-5

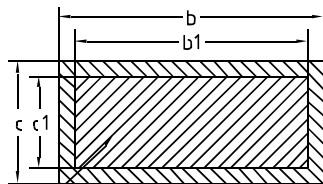
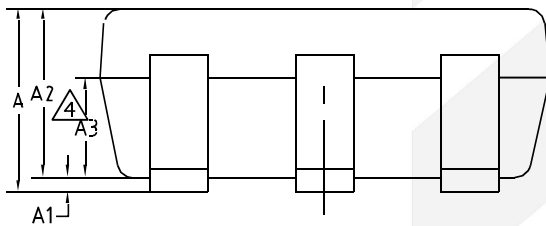
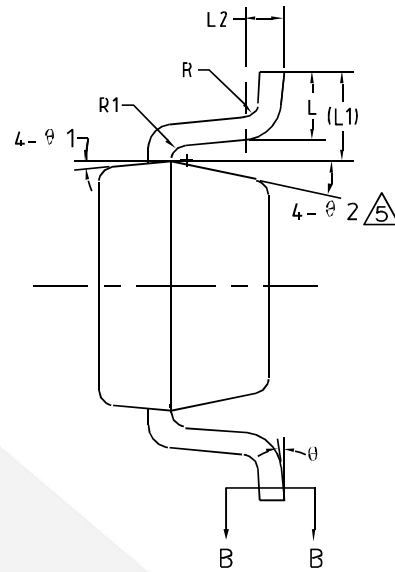
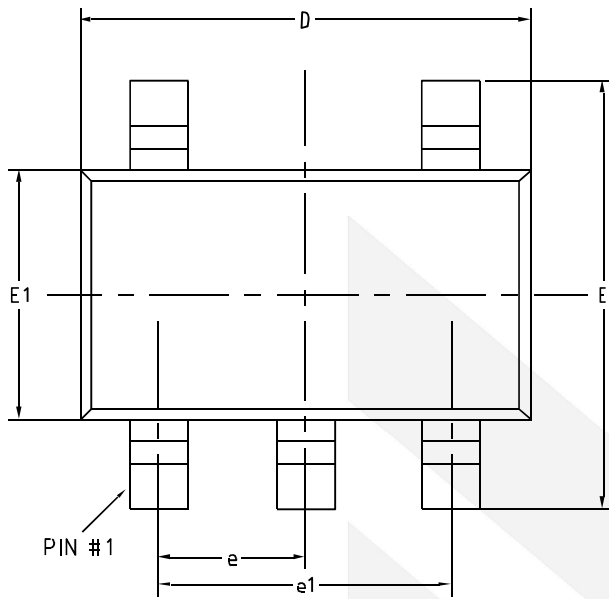

BASE METAL
SECTION B-B

COMMON DIMENSIONS (UNITS OF MEASURE=MILLIMETER)			
Symbol	MIN	NOM	MAX
A	-	-	1.25
A1	0	-	0.15
A2	1.00	1.10	1.20
A3	0.60	0.65	0.70
b	0.36	-	0.50
b1	0.36	0.38	0.45
c	0.14	-	0.20
c1	0.14	0.15	0.16
D	2.826	2.926	3.026
E	2.60	2.80	3.00
E1	1.526	1.626	1.726
e	0.90	0.95	1.00
e1	1.80	1.90	2.00
L	0.35	0.45	0.60
L1	0.59REF		
L2	0.25BSC		
R	0.10	-	-
R1	0.10	-	0.25
θ	0°	-	8°
θ1	3°	5°	7°
θ2	6°	-	14°

Physical Dimensions: SOT23-6

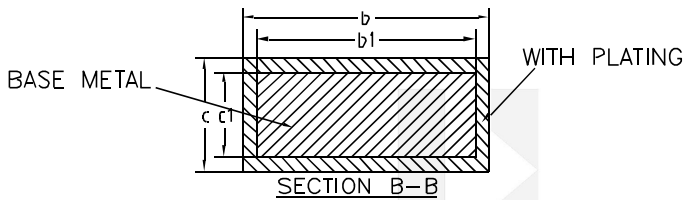
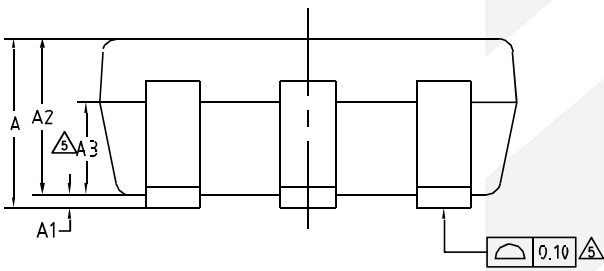
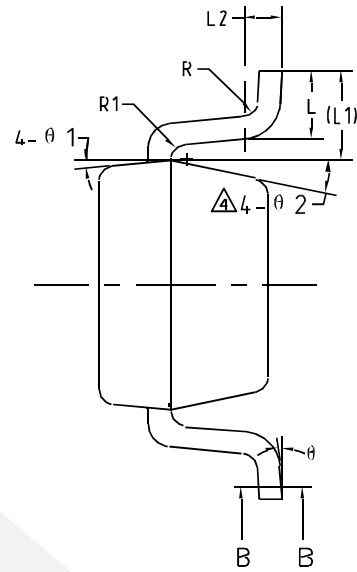
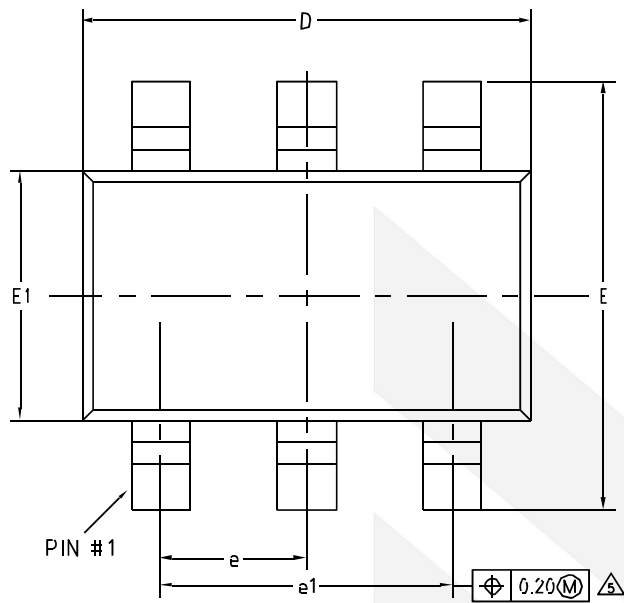

COMMON DIMENSIONS (UNITS OF MEASURE=MILLIMETER)			
Symbol	MIN	NOM	MAX
A	-	-	1.25
A1	0	-	0.15
A2	1.00	1.10	1.20
A3	0.60	0.65	0.70
b	0.36	-	0.50
b1	0.36	0.38	0.45
c	0.14	-	0.20
c1	0.14	0.15	0.16
D	2.826	2.926	3.026
E	2.60	2.80	3.00
E1	1.526	1.626	1.726
e	0.90	0.95	1.00
e1	1.80	1.90	2.00
L	0.35	0.45	0.60
L1	0.59REF		
L2	0.25BSC		
R	0.10	-	-
R1	0.10	-	0.25
Theta	0°	-	8°
Theta 1	3°	5°	7°
Theta 2	6°	-	14°

Physical Dimensions: SOIC-8

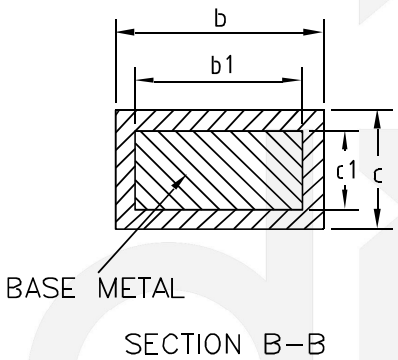
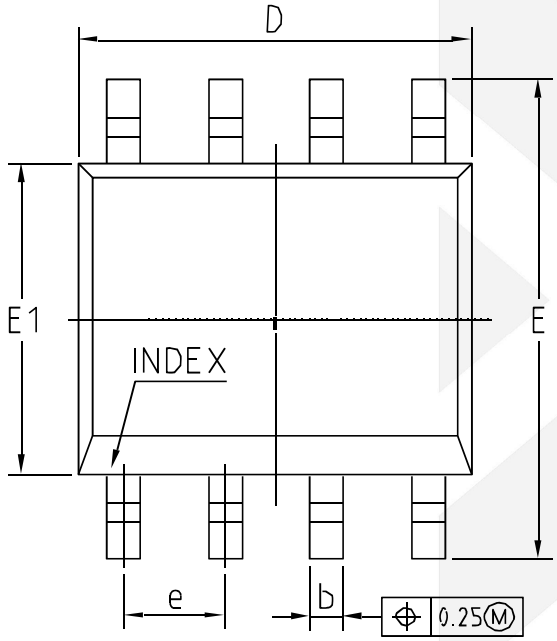
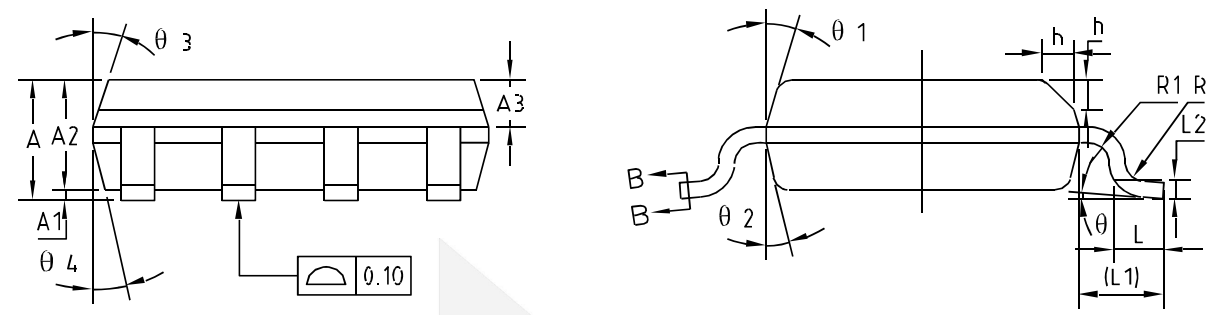

COMMON DIMENSIONS (UNITS OF MEASURE=MILLIMETER)			
Symbol	MIN	NOM	MAX
A	1.35	1.55	1.75
A1	0.10	0.15	0.25
A2	1.25	1.40	1.65
A3	0.50	0.60	0.70
b	0.38	-	0.51
b1	0.37	0.42	0.47
c	0.17	-	0.25
c1	0.17	0.20	0.23
D	4.80	4.90	5.00
E	5.80	6.00	6.20
E1	3.80	3.90	4.00
e	1.27BSC		
L	0.45	0.60	0.80
L1	1.04REF		
L2	0.25BSC		
R	0.07	-	-
R1	0.07	-	-
h	0.30	0.40	0.50
θ	0°	-	8°
θ1	15°	17°	19°
θ2	11°	13°	15°
θ3	15°	17°	19°
θ4	11°	13°	15°

Physical Dimensions: MSOP-8

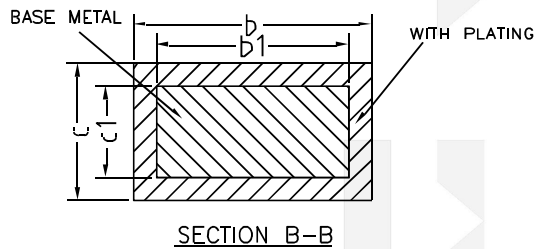
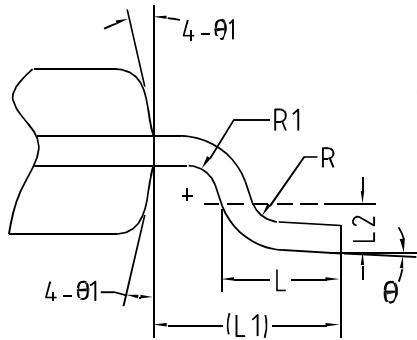
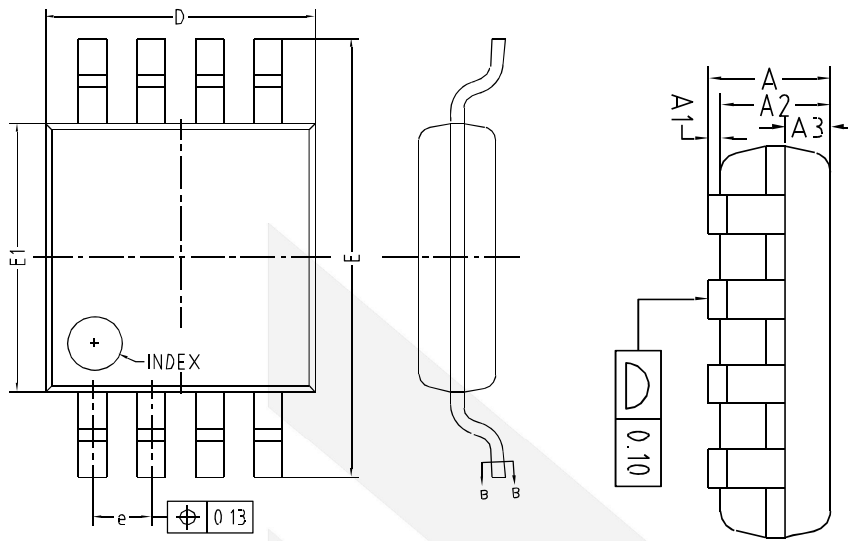

COMMON DIMENSIONS (UNITS OF MEASURE=MILLIMETER)			
Symbol	MIN	NOM	MAX
A	-	-	1.10
A1	0	-	0.15
A2	0.75	0.85	0.95
A3	0.25	0.35	0.39
b	0.28	-	0.37
b1	0.27	0.30	0.33
c	0.15	-	0.20
c1	0.14	0.15	0.16
D	2.90	3.00	3.10
E	4.70	4.90	5.10
E1	2.90	3.00	3.10
e	0.55	0.65	0.75
L	0.40	0.60	0.80
L1	0.95REF		
L2	0.25BSC		
R	0.07	-	-
R1	0.07	-	-
θ	0°	-	8°
θ1	9°	12°	15°

Physical Dimensions: SOP-14

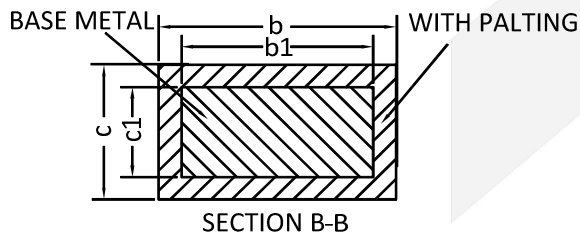
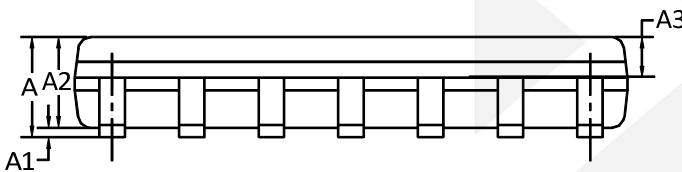
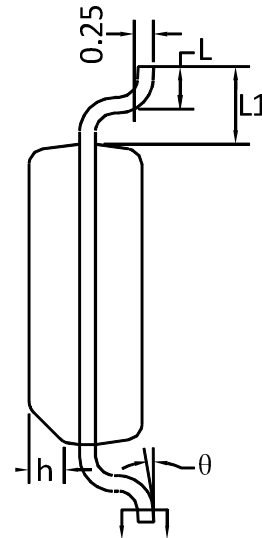
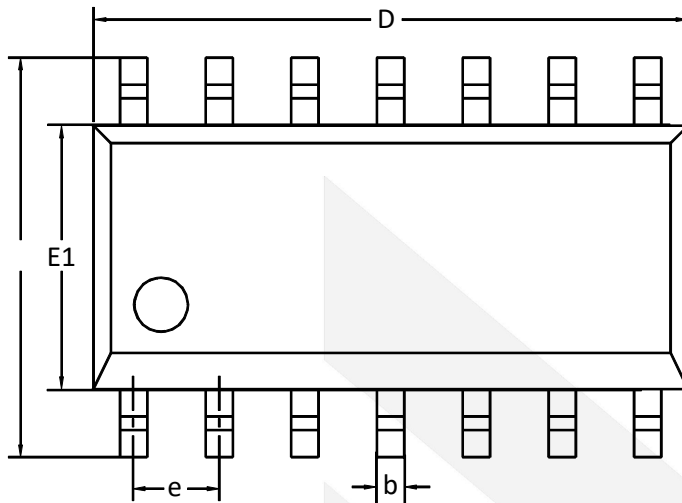

COMMON DIMENSIONS (UNITS OF MEASURE=MILLIMETER)			
Symbol	MIN	NOM	MAX
A	1.35	1.60	1.75
A1	0.10	0.15	0.25
A2	1.25	1.45	1.65
A3	0.55	0.65	0.75
b	0.36	-	0.49
b1	0.35	0.40	0.45
c	0.17	-	0.25
c1	0.17	0.20	0.23
D	8.45	8.65	8.85
E	5.80	6.00	6.20
E1	3.70	3.90	4.10
e	1.27BSC		
h	0.25	-	0.50
L	0.45	0.60	0.80
L1	1.05BSC		
θ	0°	-	8°

Physical Dimensions: TSSOP-14

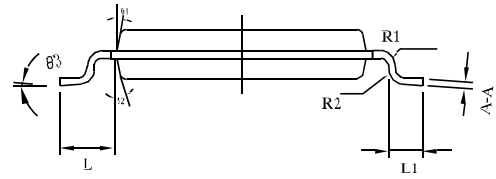
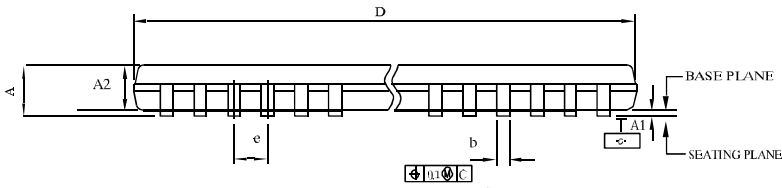

TOP VIEW

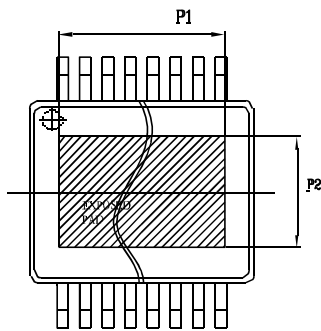
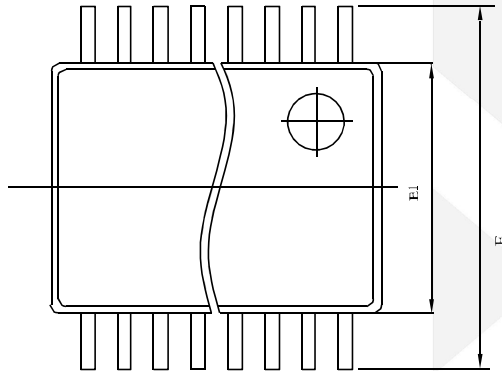

BOTTOM VIEW

COMMON DIMENSIONS (UNITS OF MEASURE=MILLIMETER)		
Symbol	Min	Max
A		1.2
A1	0.05	0.15
A2	0.8	1.05
E	6.25	6.55
E1	4.3	4.5
D	4.9	5.1
L		1
L1	0.45	0.75
e	0.65	
b	0.19	0.3
R1	0.15TYP	
R2	0.15TYP	
A-A	0.09	0.2
θ1	12° TYP	
θ2	12° TYP	
θ3	0°	8°



CONTACT US

Dioo is a professional design and sales corporation for high-quality and performance analog semiconductors. The company focuses on industry markets, such as, cell phone, handheld products, laptop, and medical equipment and so on. Dioo's product families include analog signal processing and amplifying, LED drivers and charger IC. Go to <http://www.dioo.com> for a complete list of Dioo product families.

For additional product information, or full datasheet, please contact with our Sales Department or Representatives.

