

| | | | |
|----------|------------------|-------------------|--------------------------|
| PAGE 1/8 | ISSUE 06-05-2014 | SERIES Micro-SPDT | PART NUMBER R596 XXX XXX |
|----------|------------------|-------------------|--------------------------|

An innovative and original « micro-mechanical » design allows the R596 SMT micro-relay to bring together the excellent reliability, RF and repeatability characteristics of coaxial switches with the miniature size and low cost implementation of surface mount components. Very low return loss and insertion loss allow this relay to be used in power applications, as well as in typical SMT relay applications such as RF attenuators, RF matrices, spectrum analysers, and telecommunications. Failsafe models are proposed in two RF configurations (direct and inverted) : The association of these two products on the same PC board allows to perform the « BYPASS » function very easily. (For Bypass mounting, further information is available on page7).

PICTURE

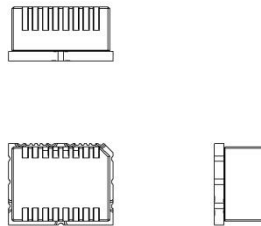
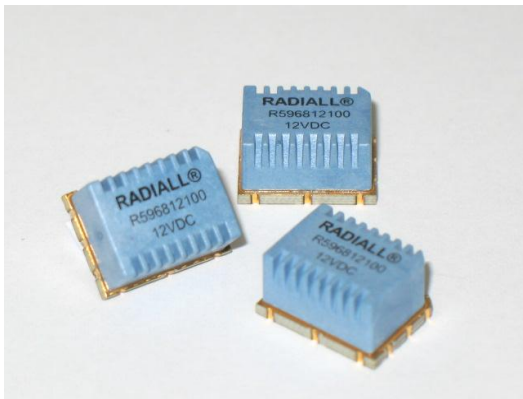

ACTUAL SIZE



TYPICAL OUTLINE DRAWING

(All dimensions in mm)

PART NUMBER SELECTION



- (1) To be associated with a failsafe model, so as to achieve the “BYPASS” function (see application details on page 7)
- (2) Non-standard packaging symbols (2, 5, 9 or T) are not marked on the relay
- (3) See details about test fixture dimensions on page 3
- (4) Tape delivered without reel, available for all specific quantities up to 200 pieces

GENERAL SPECIFICATION

| Operating mode | | Faisafe (Type 1 and 9) | | Latching (Type 3) | |
|--|--|---|---------------------------|---------------------------|---------------------------|
| Nominal operating voltage (Vdc) (across operating temperature range) | | 12 (12.2 to 13) | 24 (20.5 to 30) | 12 (12.2 to 13) | 24 (20.5 to 30) |
| Coil resistance (+/-10%) (Ohms) | | 330 | 1130 | 205 | 865 |
| Operating current at 23°C (mA) | | 36 | 25 | 58 | 32 |
| RF and command ports | | ½ hole gold plated, infrared reflow, forced air oven or hand soldering (Compatible with "lead free" soldering processes) | | | |
| Switching time (Nomial voltage) | Marking contacts | Max 4ms (Typical 1.8ms), including contact bounce time | | | |
| | Breaking contacts | Max 1ms (Typical 0.5ms) | | | |
| Life | Cold switching (Max 120 cycles/min) | 2 million cycles | | | |
| | Hot switching (Max 20 cycles/min) | 500.000 cycles (1W, impedance 50Ω , V.S.W.R. <1.25) | | | |
| Insulation | | Dielectric test voltage | | 300Vrms | |
| | | Insulation resistance at 500Vdc | | > 100MOhms | |
| Environmental protection | | « LEAD FREE » construction – Waterproof (acc.to IEC 60529 / IP67) | | | |
| Mass | | < 2g | | | |
| Operating temperature range (°C) (With no icing nor consideration) | | Faisafe - 25 to +85 (1) | | Latching - 40 to +85 | |
| Storage temperature range (°C) | | -55 to +85 | | | |
| Sine vibration (MIL STD 202, method 204) | | - Condition D : 10-2000Hz, 20g Operating - Condition G : 10-2000Hz, 30g Non-operating | | | |
| Random vibration (MIL STD 202, method 214A, Profile I) | | - Condition F : 50-2000Hz, 20.71grms Operating - Condition H : 50-2000Hz, 29.28grms Non-operating | | | |
| Shocks (According to MIL STD 202, method 213B, Cond C) | | 100g / 6ms, ½ sine Operating | | | |

(1) : Failsafe models may be used down to -40°C, but if coil remains permanently supplied at nominal voltage, the holding current value must be reduced by 45% to 55% so as to avoid internal condensation. (for more details, see RADIALL application note AN-R596-51)

PIN IDENTIFICATION (TOP VIEW)

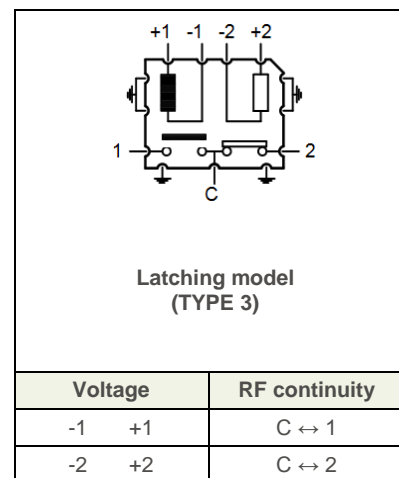
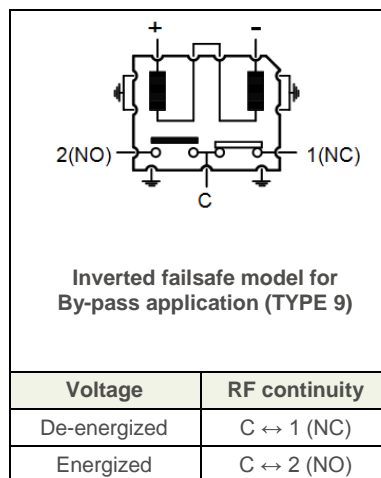
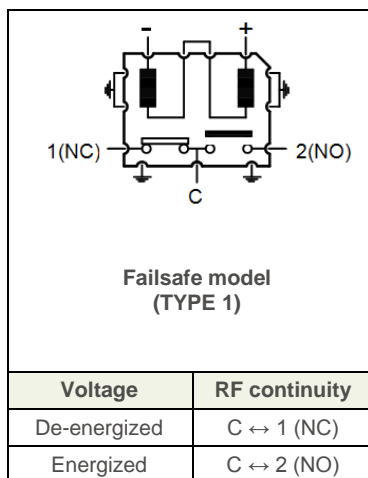

| | | | |
|----------|------------------|-------------------|--------------------------|
| PAGE 3/8 | ISSUE 06-05-2014 | SERIES Micro-SPDT | PART NUMBER R596 XXX XXX |
|----------|------------------|-------------------|--------------------------|

RF PERFORMANCES

| Frequency Range (GHz) | | V.S.W.R | Insertion | Isolation (min) dB | | Average power W | | Third order | Impedance |
|-----------------------|--------|---------|---------------|--------------------|---------------------------|-----------------|---------------|--|-----------|
| | | (max) | Loss (max) dB | switch alone | switch + board layout (1) | cold switching | hot switching | Inter modulation | Ohms |
| DC – 3 DC – 8 | DC – 1 | 1.10 | 0.10 | 50 | 50 | 400 | 50 | -120 dBc typical (2 carriers 20W) | 50 |
| | 1 – 2 | 1.20 | 0.20 | 45 | 40 | 280 | 50 | | |
| | 2 – 3 | 1.35 | 0.30 | 40 | 30 | 175 | 40 | | |
| | 3 – 6 | 1.35 | 0.40 | 35 | 30 | 50 | 25 | | |
| | 6 – 8 | 1.40 | 0.80 | 30 | 30 | 35 | 5 | | |

TYPICAL RF PERFORMANCES

Insertion Loss and Isolation



V.S.W.R.



(1) : taking account of the reduction of isolation due to coupling between PCB microstrip lines (see isolation dotted curve above and measurement method below)

MEASUREMENT METHOD

Relay soldered on Test Fixture (2)



Calibration board



Inputs/Outputs of the calibration board and test fixture are equipped with SMA type receptacle connectors, RADIALL part number R125 510 000. The length of the RF tracks are the same on the calibration board and the test fixture circuits. The insertion loss of the relay itself is calculated by subtracting the insertion loss of the “calibration board” to the insertion loss of the “relay welded on the test fixture”.

(2) : Relay soldered on Test Fixture available. To order, please use the suffix « T » (part number R596 - - - - - T), as explained in page 1.

RF POWER RATING FOR COLD SWITCHING USE (impedance 50 Ohms , V.S.W.R < 1.25)

Power level depends on environmental conditions :

- R596 series relays have been designed to be used without cooling fan even for high power applications. However, the power capability may be improved by using an appropriate cooling fan.
- For failsafe models used with coil permanently supplied (NO position), the same power level as latching models may be applied: see application note Nr AN-R596-51, how to implement a "low holding current" function on your PC board, so as to avoid internal overheating and increase the RF power level.



LIFE DERATING CURVE FOR HOT SWITCHING USE

Impedance 50Ω
V.S.W.R. <1.25
max switching frequency : 30 cycles per mn



RELAY PACKAGING

ACCORDING TO IEC 286-3 STANDARD

MATERIALS

Reel : polyester

Carrier tape : antistatic PETG (polyester)

Cover tape : polyester



Video shadow of the relay



Aspiration area



PC BOARD MOUNTING

Board layout

DXF or GERBER format file
Available upon request (1)



Substrate Types

Recommended substrates are **ROGERS RO4003** or **ARLON 25N**,

- **Mounting face** : Thickness 0.813 mm Cu double side 17.5µm. Width of track 1.83 mm
 - o Others substrates : **RO4350** , thickness 0.813 mm Cu double side 17.5µm. Width of track 1.80 mm
 - 25FR** , thickness 0.813 mm Cu double side 17.5µm. Width of track 1.76 mm
- **Opposite face** : Plating all over the face.

Total thickness of the tracks (copper over thickness + plating) : 40µm.

Other substrates may be used (for instance standard FR4), if provided with adequate modification of the track width.

Relay soldering and varnish pattern (DXF format file available upon request (1))

Soldering pattern



Varnish pattern



(1) : Please contact us by E-mail : switchingproducts@radiall.com

BYPASS APPLICATION : FAILSAFE MICRO-RELAYS TYPICAL IMPLANTATION

SPDT relays (Single Pole Double Throw) can be used to achieve a Bypass switch function. For SMT applications, R596 series relays are available in two failsafe versions - standard and inverted - to provide symmetric RF ports implantation possibility. The "side by side" implementation of these two versions on a PCB effectively produces a « BYPASS » function : the package size is reduced and interconnecting tracks are shortened.

As required to protect the receiver for transmit/receive applications, and depending on the distance between the two relays, this configuration can achieve high isolation levels, up to: 80 dB @ 1GHz, 70 dB @ 2 GHz, and 60 dB @ 6GHz.

BYPASS TYPICAL IMPLANTATION AND PIN IDENTIFICATION (TOP VIEW)



BYPASS PC BOARD MOUNTING

Example of Borad layout for BY-PASS application



ACTUAL SIZE

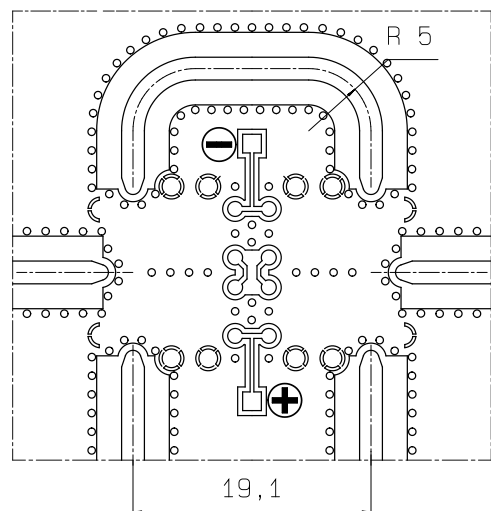

(See detailed board layout on page 6)

RECOMMENDED SOLDERING PROCEDURE

A – Soldering procedure using automatic pick and place equipment

1-Solder paste :

R596 series are « Lead Free », and Lead Free Sn-Ag3.5-Cu0.7 solder cream may be used as well as standard Sn63–Pb35–Ag2. RADIALL recommends using a « no clean - low residue » solder cream (5% solid residue of flux quantity) that will permit the elimination of the cleaning operation step after soldering.

Note : Due to the gold plating of the switch PCB interface, it is important to use a paste made with silver. This will help in avoiding formation of intermetallics as part of the solder joint.

2-Solder paste deposition :

Solder cream may be applied on the board with screen printing or dispenser technologies. For either method, the solder paste must be coated to appropriate thickness and shapes to achieve good solder wetting. Please optically verify that the edges of the zone are clean and without contaminates, and that the PCB zoned areas have not oxydated. The design of the mounting pads and the stenciling area are given on page 6, for a thickness of the silk-screen printing of 0.15 mm (0.006 ").

3-Placement of the component :

For small lightweight components such as chip components, a self-alignment effect can be expected if small placement errors exist. However, this effect is not as expected for relays components and they require a accurate positioning on their soldering pads, typically +/- 0.1mm (+/-0.004").

Place the relay onto the PCB with automatic pick and place equipment. Various types of suction can be used.

RADIALL does not recommend using adhesive agents on the component or on the PCB.

4-Soldering : infra-red process

Please follow the RADIALL recommended temperature profile for infra-red reflow or forced air convection :

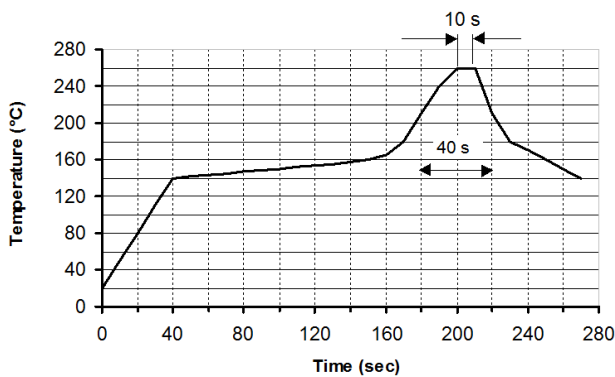

Higher temperature (>260°C) and longer process duration would damage permanently the switches.

5-Cleaning procedure :

On miniature relays, high frequency cleaning may cause the contacts to stick. If cleaning is needed, please avoid ultrasonic cleaning and use alcohol based cleaning solutions.



In-line cleaning process, spraying, immersion, especially under temperature, may cause a risk of degradation of internal contacts.

6-Quality check :

Verify by visual inspection that the component is centred on the mounting pads.

Solder joints : verify by visual inspection that the formation of meniscus on the pads are proper, and have a capillarity amount upper the third of the height.

B – Soldering procedure by manual operation

1-Solder paste and flux deposition :

Refer to procedure A – 1

Deposite a thin layer of flux on mounting zone.

Allow the flux to evaporate a few seconds before applying the solder paste, in order to avoid dilution of the paste.

2-Solder paste deposition :

RADIALL recommends depositing a small amount of solder paste on the mounting zone area by syringe.

Be careful, not to apply solder paste outside of the zone area.

3-Placement of the component :

During manipulation, avoid contaminating gold surfaces by contact with fingers.

Place the component on the mounting zone by pressing on the top of the relay lid.

4-Hand soldering :

Iron wattage 30 to 60 W.

Tip temperature 280 to 300°C for max. 5 seconds

To keep good RF characteristics above 3GHz, it is important to solder RF ports first, and apply pressure on the relay lid during all the soldering stage, so as to reduce the air gap between the PC board and the relay.

5-Cleaning procedure :

Refer to procedure A – 5.

6-Quality check:

Verify by visual inspection that component is centred on the mounting pads.

Solder joints : verify by visual inspection that the formation of meniscus on the RF pads are proper, and have a capillarity amount higher than one third of the height.