

## Broadband CATV 8-Way Active Splitter with default loop-through Switch 50 - 1100 MHz

Rev. V1

### Features

- Always ON loop-through path
- 8-Way Splitter
- 1.5 dB Gain
- +15 dBm V /Channel Input
- Single 5 Volt Bias
- Lead-Free 4 mm 24-Lead PQFN Package
- RoHS\* Compliant and 260°C Reflow Compatible

### Description

The MAAM-010237 CATV 8-way active splitter with the default loop-through path is a GaAs MMIC which exhibits low noise figure and distortion in a lead-free 4mm 24-lead PQFN plastic package. The design features 75  $\Omega$  inputs and outputs.

This device is ideally suited for multi-tuner set top boxes, home gateways, and other broadband internet based applications.

The MAAM-010237 is fabricated using M/A-COM Technology Solutions' E/D pHEMT process to realize default loop-through operation, low noise and low distortion. The process features full passivation for robust performance and reliability.

### Functional Schematic, Default On, Power Off

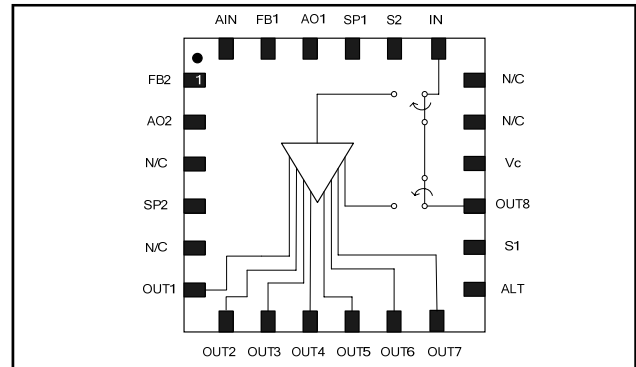

### Functional Schematic, Power On

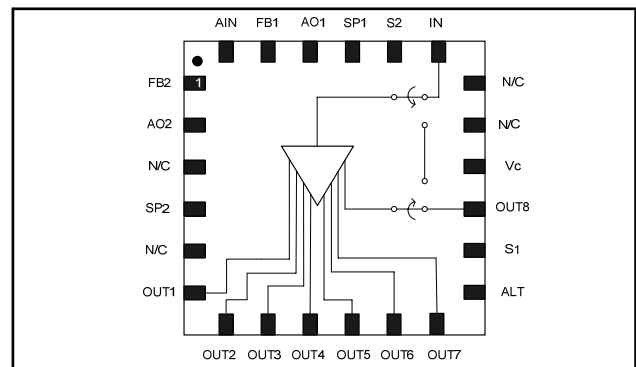

### Pin Configuration

Pin No.	Function	Pin No.	Function
1	Feedback 2	13	Alternate Output
2	Amplifier Output 2	14	Switch In
3	No Connection	15	RF Output 8
4	Splitter 2	16	Voltage Control
5	No Connection	17	No Connection
6	RF Output 1	18	No Connection
7	RF Output 2	19	RF Input
8	RF Output 3	20	Switch Output
9	RF Output 4	21	Splitter 1
10	RF Output 5	22	Amplifier Output 1
11	RF Output 6	23	Feedback 1
12	RF Output 7	24	Amplifier Input
		25	Paddle <sup>3</sup>

### Ordering Information<sup>1,2</sup>

Part Number	Package
MAAM-010237-TR1000	1000 piece reel
MAAM-010237-TR3000	3000 piece reel
MAAM-010237-001SMB	Sample Test Board

1. Reference Application Note M513 for reel size information.
2. All sample boards include 5 loose parts.

\*Restrictions on Hazardous Substances, European Union Directive 02/95/EC.

3. The exposed paddle centered on the package bottom must be connected to RF, DC and thermal ground.

## Broadband CATV 8-Way Active Splitter with default loop-through Switch 50 - 1100 MHz

Rev. V1

### Electrical Specifications: $T_A = 25^\circ\text{C}$ , $Z_0 = 75 \Omega$

Parameter	Test Conditions	V <sub>DD</sub> (V)	V <sub>C</sub> (V)	Units	Min.	Typ.	Max.
Gain	In to Out1, 2, 3, 4, 5, 6, 7, or 8 400 MHz 900 MHz	5	3.3	dB	0 -	1.5 4.0	2.6 -
Insertion Loss	In to Out8 400 MHz 900 MHz	0	0	dB	- -	0.6 1.0	- 1.2
Noise Figure	In to Out1, 2, 3, 4, 5, 6, 7, or 8	5	3.3	dB	-	4.75	-
Input Return Loss	Input	5	3.3	dB	-	10	-
Input Return Loss	Input	0	0	dB	-	16	-
Output Return Loss	Output	5	3.3	dB	-	10	-
Output Return Loss	Output	0	0	dB	-	9.5	-
Out to Out Isolation	Out1 to Out2, 3, 4, 5, 6, 7, or 8	5	3.3	dB	-	22	-
Out to Out Isolation	Out1 to 2, 3, 4, 5, 6, or 7	0	0	dB	-	20	-
CTB	132 Ch, +15 dBmV/Ch at the Input	5	3.3	dBc	-	-65	-
CSO	132 Ch, +15 dBmV/Ch at the Input	5	3.3	dBc	-	-50	-
Reverse Isolation	Out1, 2, 3, 4, 5, 6, 7 to In	5	3.3	dB	-	35	-
Reverse Isolation	Out8 to In	5	3.3	dB	-	30	-
Reverse Isolation	Out1, 2, 3, 4, 5, 6, 7 to In	0	0	dB	-	42	-
OIP2	400 MHz, 2-tone, 6 MHz spacing, -10 dBm Pout	5	3.3/0	dBm	-	30	-
OIP3	400 MHz, 2-tone, 6 MHz spacing, -10 dBm Pout	5	3.3/0	dBm	-	22	-
P1dB	400 MHz	5	3.3	dBm	-	6	-
P1dB	400 MHz	5	0	dBm	-	25	-
I <sub>DD</sub>		5	3.3	mA	-	190	220
I <sub>C</sub>		5	3.3	μA	-	230	300

4. The unpowered state is the same as V<sub>control</sub> = 0 V

## Broadband CATV 8-Way Active Splitter with default loop-through Switch 50 - 1100 MHz

Rev. V1

### Absolute Maximum Ratings<sup>5,6</sup>

Parameter	Absolute Maximum
Max Input Power	+5 dBm
V <sub>DD</sub>	+10.0 V
V <sub>CONTROL</sub>	+8.5 V
Junction Temperature <sup>7,8</sup>	+150°C
Operating Temperature	-20°C to +85°C
Storage Temperature	-65°C to +150°C

5. Exceeding any one or combination of these limits may cause permanent damage to this device.
6. M/A-COM Technology Solutions does not recommend sustained operation near these survivability limits.
7. Operating at nominal conditions with T<sub>J</sub> ≤ +150°C will ensure MTTF > 1 x 10<sup>6</sup> hours.
8. Junction Temperature (T<sub>J</sub>) = T<sub>A</sub> + Θ<sub>JC</sub> \* (V \* I)  
Typical thermal resistance (Θ<sub>JC</sub>) = 73 °C/W.
  - a) For T<sub>A</sub> = 25°C,  
T<sub>J</sub> = 95 °C @ 5.0 V, 190 mA
  - b) For T<sub>A</sub> = 85°C,  
T<sub>J</sub> = 149 °C @ 5.0 V, 175 mA

### PCB Land Pattern

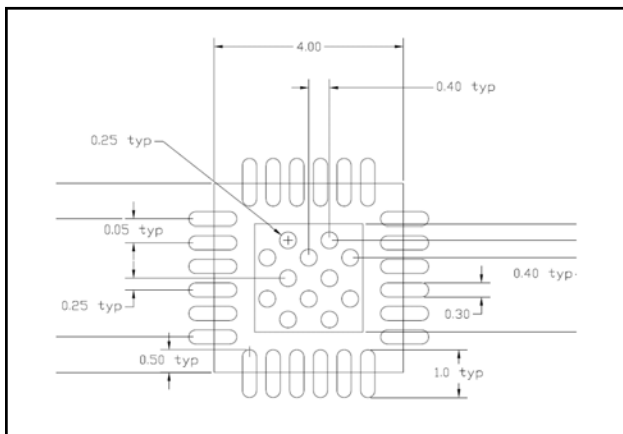

### Truth Table<sup>9</sup>

V <sub>DD</sub>	V <sub>CONTROL</sub>	IN - OUT1, 2, 3, 4, 5, 6 or 7	IN - OUT8
5 V	1	On	On
0 V	0	Off	On

9. V<sub>CONTROL</sub> for Logic "1" = +3 to +5 volts, Logic "0" = 0 ± 0.2 volts.

### Handling Procedures

Please observe the following precautions to avoid damage:

### Static Sensitivity

Gallium Arsenide Integrated Circuits are sensitive to electrostatic discharge (ESD) and can be damaged by static electricity. Proper ESD control techniques should be used when handling these devices. An external protection circuit using an anti-parallel diode pair can be used to protect the IC.

Please reference application note AN3028 on <http://www.macomtech.com> for further detail.

## Broadband CATV 8-Way Active Splitter with default loop-through Switch 50 - 1100 MHz

Rev. V1

### Schematic Including Off-Chip Components

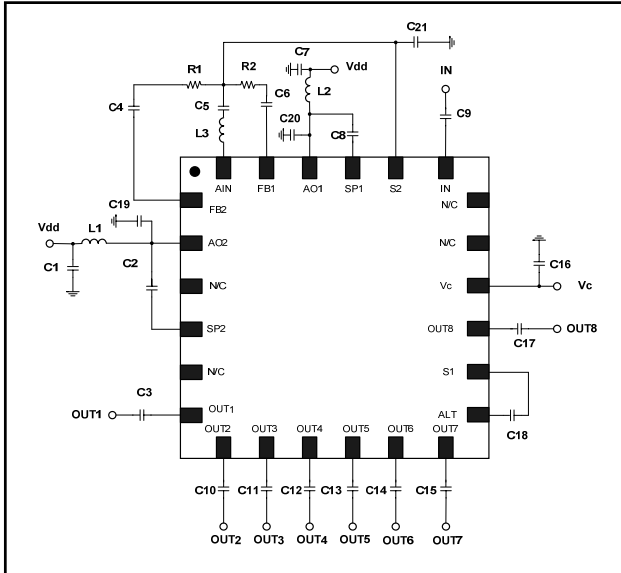

### Recommended PCB Layout

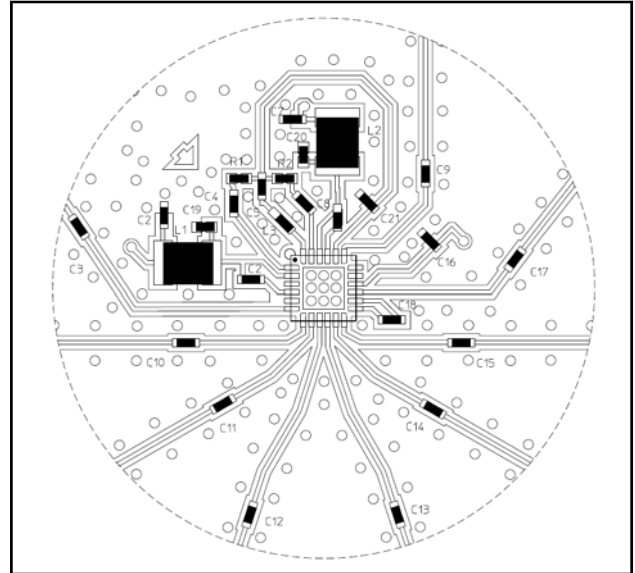

### Off-Chip Component Values

Component	Value	Package
C1 - C18	0.01 $\mu$ F	0402
C19, C20	2.2 pF	0402
C21	1.5 pF	0402
L1 & L2 <sup>10</sup>	1 $\mu$ H	1210
L3	6.8 nH	0402
R1, R2	390 $\Omega$	0402

10. L1 & L2 supplied from EPCOS, part number B82422A1102K100

### Block Diagram RF Signal Flow

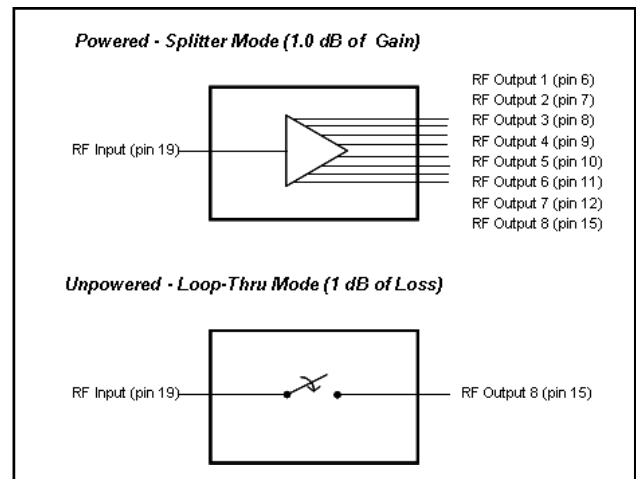

## Broadband CATV 8-Way Active Splitter with default loop-through Switch 50 - 1100 MHz

Rev. V1

### Typical Performance Curves

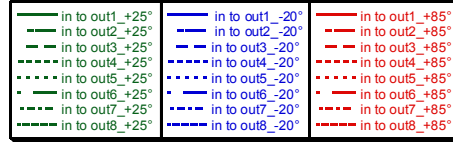

#### Gain

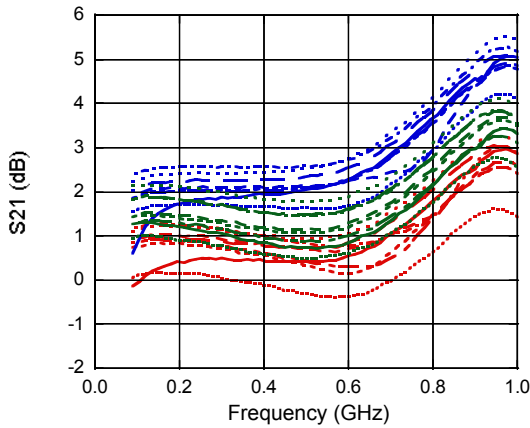

#### Gain to 3 GHz

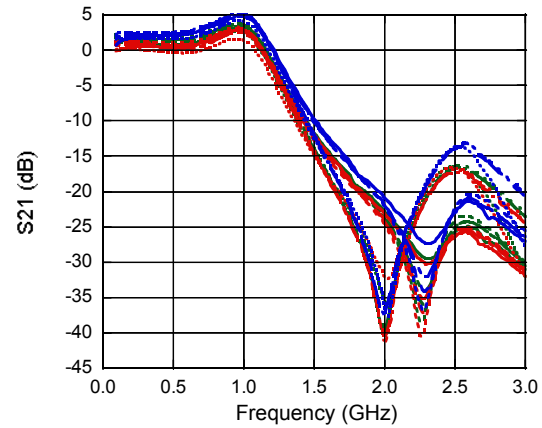

#### Input Return Loss (power on)

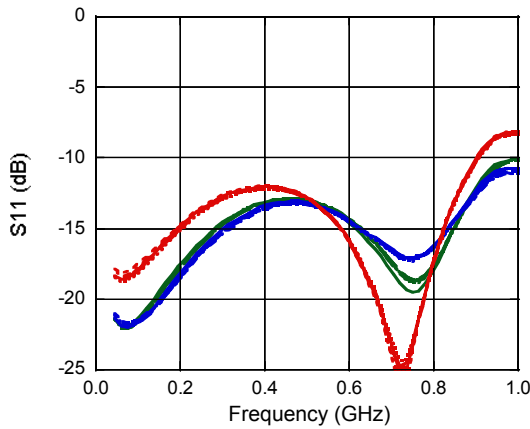

#### Input Return Loss (power off)

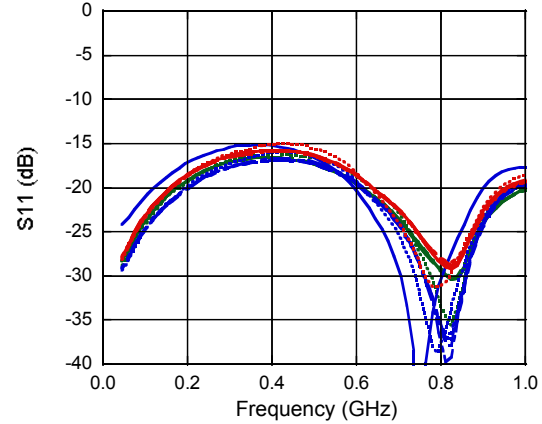

#### Output Return Loss (power on)

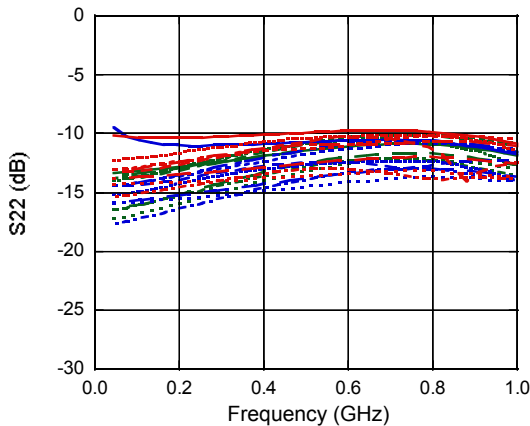

#### Output Return Loss (power off)

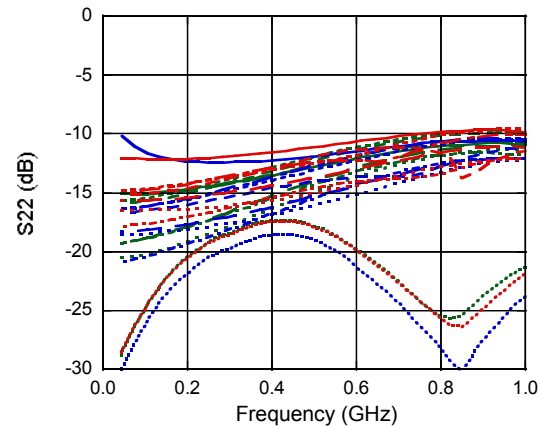

## Broadband CATV 8-Way Active Splitter with default loop-through Switch 50 - 1100 MHz

Rev. V1

### Typical Performance Curves

Insertion Loss to 1 GHz (power off)

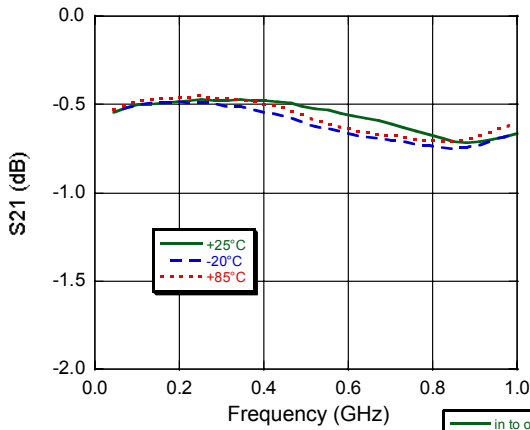

Insertion Loss to 3 GHz (power off)

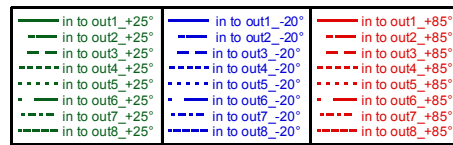
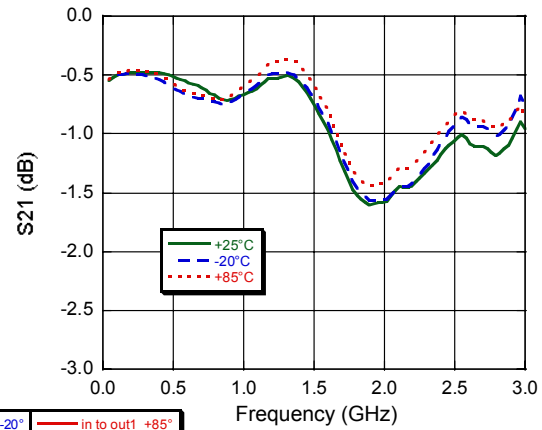

Reverse Isolation to 3 GHz (power on)

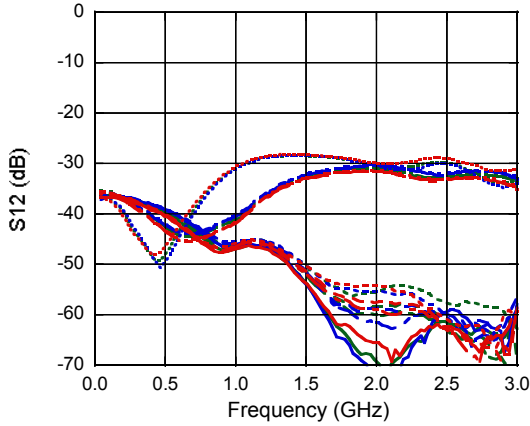

Reverse Isolation to 3 GHz (power off)

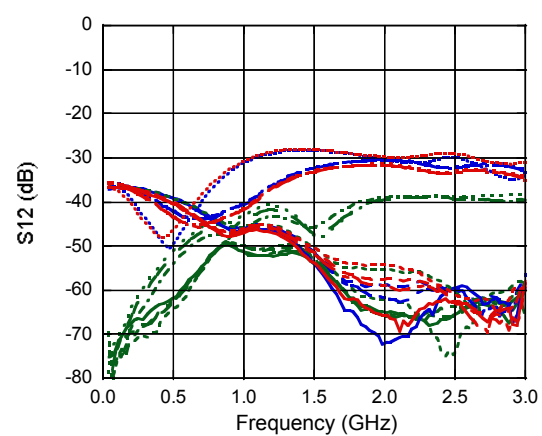

### Noise Figure

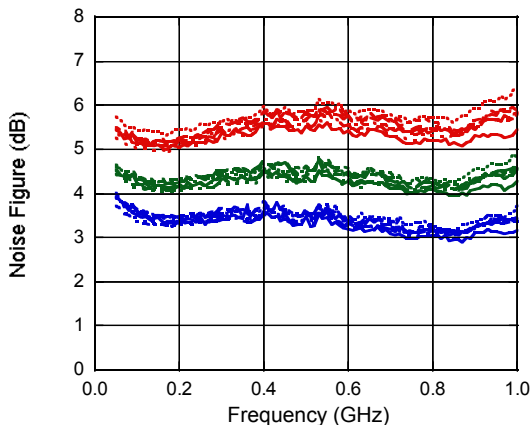

### Typical Performance Curves

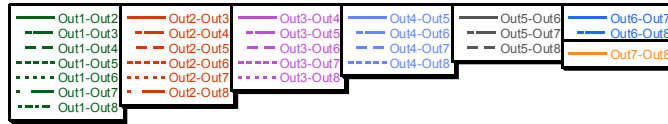

**Out to Out Isolation to 1 GHz (power on)**

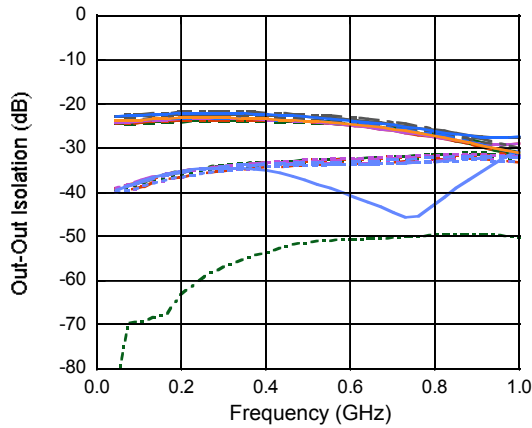

**Out to Out Isolation to 3 GHz (power on)**

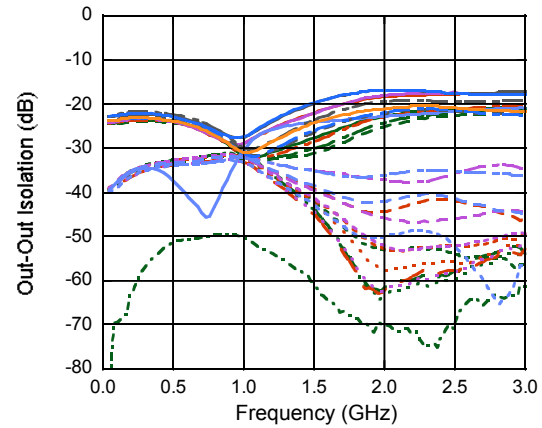

**Out to Out Isolation to 1 GHz (power off)**

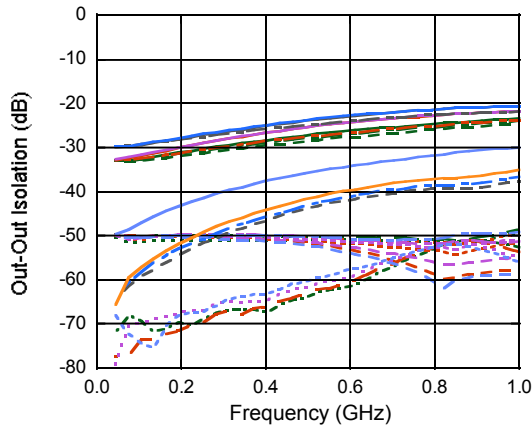

**Out to Out Isolation to 3 GHz (power off)**

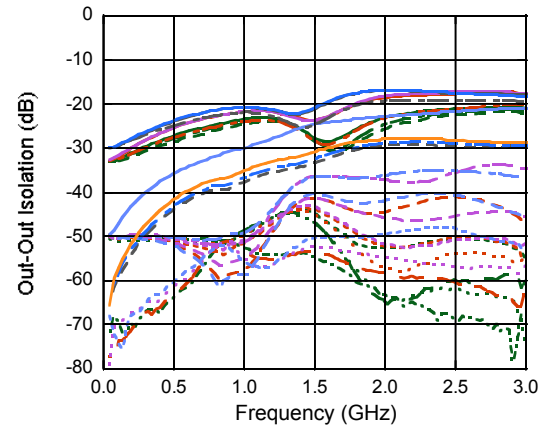

### Lead-Free 4 mm 24-Lead PQFN†

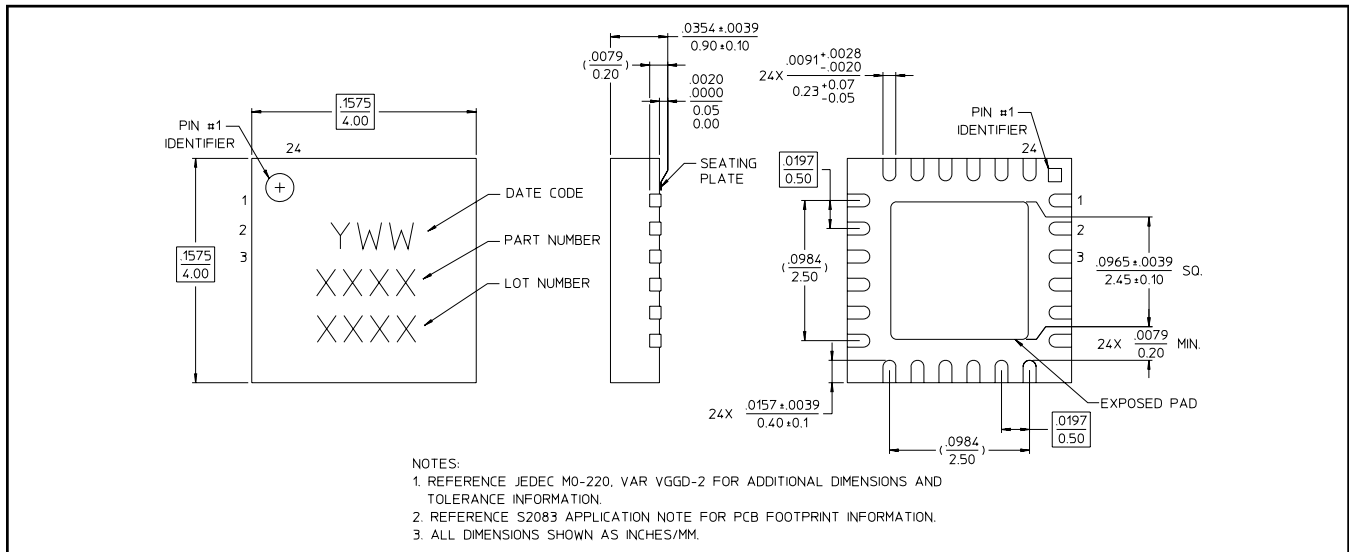

† Reference Application Note S2083 for lead-free solder reflow recommendations.  
 Meets JEDEC moisture sensitivity level 1 requirements.  
 Plating is 100% matte tin over copper.