

Table of Contents



The Pulse Electronics 0402 - 1806 series ranges of Miniature Ferrite beads contains the very latest in multi layer ferrite beads technology, thus providing the ultimate in performance demanded by today's high Speed EMI noise filtering products. The ferrite beads are in an industry standard size and footprint.

| | |
|--|-------|
| Ferrite beads | 2 |
| Parts number Legend..... | 2 |
| Competitor Cross | 3 |
| Reliability and Test Condition..... | 3-5 |
| Derating Curve | 5 |
| Product Specifications | |
| Soldering | 5 |
| Lead Free Solder re-flow | 6 |
| Solder Iron | 6 |
| Solder Volume | 6 |
| Packaging Information | 7 |
| Reel Dimension | 7 |
| Qty/reel | 7 |
| Tearing Off Force | 7 |
| Application Notes | 8 |
| Ferrite Bead EMI Suppressor | |
| Single Type - 0402FB, 0603FB & 0805FB Series | 9-10 |
| Single GHz Type - 00402HFB & 0603HFB Series | 11-12 |
| Power Type - 0603PFB, 0805PFB, 1206PFB, & 1806PFB Series | 13-14 |

CHIP FERRITE BEADS

1.0 Ferrite Beads

It is known as absorptive beads, is more lossy and make good power filter networks because they are designed to absorb high-frequency noise currents and dissipate it as heat. These beads have high impedance over wide high-frequency bands, making them ideal as low-pass noise filters.

Structure

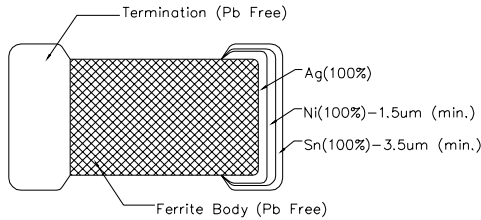

Equivalent Circuit

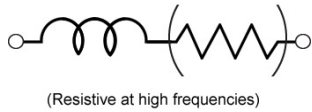

FREQUENCY (MHz)
 Z = Impedance (ohm)
 R = Real Part (resistance)
 X = imaginary Part (inductance)

Application



2.0 Parts Number Legend

| PE-0201 | FB | 121 | S | T | A |
|-----------------------------------|---|------------------------|--|-----------------|-----------------|
| PACKAGE STYLE | CORE MATERIAL | Impedance (Ω) | TOLERANCE * | PACKAGE | Enhanced |
| 0402, 0603, 0805, 1206 1806 | FB = Ferrite Bead HFB = High Frequency Ferrite Bead PFB = High Current Ferrite Bead | 121=120 Ω | J = $\pm 5\%$ S = $\pm 25\%$ X = not apply | T = Tape & Reel | A = Alternative |

* There is no tolerance option for these products.

CHIP FERRITE BEADS

3.0 Competitor Cross

| ITEM | Pulse | TAIYO YUDEN | TDK | MURATA |
|---------------------------|------------|-----------------|------------------|--|
| Ferrite Bead Single | FB Series | BK & FBM Series | MMZ Series | BLMxxAG Series BLMxxBD Series BLMxxAX Series |
| GHz Ferrite Beads Single | HFB Series | FBMH Series | MMZ1005-E Series | BLMxxH Series |
| Power Ferrite Bead Single | PFB Series | | | BLMxxPG Series |

4.0 Reliability and Test Condition

| Item | Performance | Test Condition |
|------------------------------------|--|--|
| Series No. | PE-0402FB/0603FB/0805FB/0402HFB/0603HFB/ | |
| Operating Temperature | -40 ~+105°C (Including self-temperature rise) | |
| Transportation Storage Temperature | -40 ~+125°C | |
| Impedance (Z) | Refer to standard electrical characteristics list | Agilent4291 |
| Inductance (Ls) | | AgilentE4991 |
| Q Factor | | Agilent4287 |
| DC Resistance | | Agilent16192 |
| Rated Current | | Agilent4338 DC Power Supply Over Rated Current requirements |
| Temperature Rise Test | Rated Current < 1A ΔT 20°C Max Rated Current \geq 1A ΔT 20°C Max | 1. Applied the allowed DC current 2. Temperature measured by digital surface thermometer |
| Resistance to Soldering Heat | Appearance: No damage Impedance: Within $\pm 15\%$ of initial value Inductance: Within $\pm 10\%$ of initial value Q: Shall not exceed the specification value. RDC: Shall not exceed the specification value. | Preheat: 150°C, 60sec Solder: Sn99.5%-Cu0.5% Solder temperature: 260 \pm 5°C Flux for lead free: Rosin.9.5% Temperature ramp/immersion and immersion rate: 25 \pm 6 mm/s Dip time: 10 \pm 1sec. Depth: completely cover the termination. |

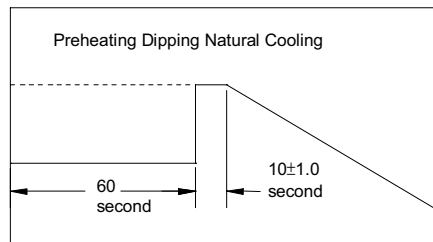

CHIP FERRITE BEADS

4.0 Reliability and Test Condition

| Item | Performance | Test Condition | | | | | | | | | | | | | | | |
|-------------------|---|---|-----------|----------------------------|--------------------------|-----------|----------------------------|-----|-------|-----|-----------|------|------|-----|---|-----------|------|
| Solderability | <p>More than 95% of the terminal electrode should be covered with solder</p>  | <p>Preheat: 150°C, 60sec</p> <p>Solder: Sn99.5%-Cu0.5%</p> <p>Solder temperature: 245±5°C</p> <p>Flux for lead free: Rosin.9.5%</p> <p>Depth: completely cover the termination.</p> <p>Dip time: 4±1sec.</p> | | | | | | | | | | | | | | | |
| Terminal strength | <p>Appearance: No damage.</p> <p>Impedance: within ±15% of initial value</p> <p>Inductance: within ±10% of initial value</p> <p>Q: Shall not exceed the specification value.</p> <p>RDC: Shall not exceed the specification value.</p>  | <p>Preconditioning: Run through IR reflow for 2 times. (IPC/JEDEC J-STD-020E Classification Reflow Profiles)</p> <p>Component mounted on a PCB apply a force (>0805:1kg<=0805:0.5kg) to the side of a device being tested. This force shall be applied for 60 +1 seconds. Also the force shall be applied gradually as not to shock the component being tested.</p> | | | | | | | | | | | | | | | |
| Bending | <p>Appearance: No damage.</p> <p>Impedance: within ±10% of initial value</p> <p>Inductance: within ±10% of initial value</p> <p>Q: Shall not exceed the specification value</p> <p>RDC: Shall not exceed the specification value</p> | <p>Shall be mounted on a FR4 substrate of the following dimensions: >=0805:40x100x1.2mm <0805:40x100x0.8mm</p> <p>Bending depth: >=0805:1.2mm</p> <p>Duration of 10 sec for a min.</p> | | | | | | | | | | | | | | | |
| Vibration Test | <p>Appearance: No damage.</p> <p>Impedance: within ±15% of initial value</p> <p>Inductance: within ±10% of initial value</p> <p>Q: Shall not exceed the specification value</p> <p>RDC: within ±15% of initial value and shall not exceed the specification value</p> | <p>Preconditioning: Run through IR reflow for 2 times. (IPC/JEDEC J-STD-020E Classification Reflow Profiles)</p> <p>Oscillation Frequency: 10 2K 10Hz for 20 minutes</p> <p>Equipment: Vibration checker</p> <p>Total Amplitude: 1.52mm ±10%</p> <p>Testing Time: 12 hours (20 minutes 12 cycles each of 3 orientations).</p> | | | | | | | | | | | | | | | |
| Shock | <p>Appearance: No damage.</p> <p>Impedance: within ±15% of initial value</p> <p>Inductance: within ±10% of initial value</p> <p>Q: Shall not exceed the specification value</p> <p>RDC: within ±15% of initial value and shall not exceed the specification value</p> | <p>Test condition:</p> <table border="1" data-bbox="1062 1650 1500 1860"> <thead> <tr> <th>Type</th> <th>Peak Value (g's)</th> <th>Normal duration (D) (ms)</th> <th>Wave form</th> <th>Velocity change (Vi)ft/sec</th> </tr> </thead> <tbody> <tr> <td>SMD</td> <td>1,500</td> <td>0.5</td> <td>Half-sine</td> <td>15.4</td> </tr> <tr> <td>Lead</td> <td>100</td> <td>6</td> <td>Half-sine</td> <td>12.3</td> </tr> </tbody> </table> | Type | Peak Value (g's) | Normal duration (D) (ms) | Wave form | Velocity change (Vi)ft/sec | SMD | 1,500 | 0.5 | Half-sine | 15.4 | Lead | 100 | 6 | Half-sine | 12.3 |
| Type | Peak Value (g's) | Normal duration (D) (ms) | Wave form | Velocity change (Vi)ft/sec | | | | | | | | | | | | | |
| SMD | 1,500 | 0.5 | Half-sine | 15.4 | | | | | | | | | | | | | |
| Lead | 100 | 6 | Half-sine | 12.3 | | | | | | | | | | | | | |

CHIP FERRITE BEADS

| | | |
|-----------------------|--|--|
| Life Test | Appearance: No damage. Impedance: within $\pm 15\%$ of initial value Inductance: within $\pm 10\%$ of initial value Q: Shall not exceed the specification value RDC: within $\pm 15\%$ of initial value and shall not exceed the specification value | Preconditioning: Run through IR reflow for 2 times. (IPC/JEDEC J-STD-020E Classification Reflow Profiles) Temperature: $125 \pm 2^\circ\text{C}$ (bead), $85 \pm 2^\circ\text{C}$ (inductor) Applied current: rated current Duration: 1000 ± 12 hrs. Measured at room temperature after placing for 24 ± 2 hrs. |
| Load Humidity | | Preconditioning: Run through IR reflow for 2 times. (IPC/JEDEC J-STD-020E Classification Reflow Profiles) Humidity: $85 \pm 2\%$ R.H. Temperature: $85 \pm 2^\circ\text{C}$ Duration: 1000hrs Min. with 100% rated current. Measured at room temperature after placing for 24 ± 2 hrs. |
| Thermal Shock | Appearance: no damage Impedance: within $\pm 15\%$ of initial value Inductance: within $\pm 10\%$ of initial value Q: Shall not exceed the specification value RDC: Shall not exceed the specification value | Preconditioning: Run through IR reflow for 2 times. (IPC/JEDEC J-STD-020E Classification Reflow Profiles) Condition for 1 cycle Step1: $-40 \pm 2^\circ\text{C}$ 30 ± 5 min. Step2: $25 \pm 2^\circ\text{C} \leq 30 \pm 0.5$ min. Step3: $+105 \pm 2^\circ\text{C}$ 30 ± 5 min. Number of cycles: 500 Measured at room temperature after placing for 24 ± 2 hrs. |
| Insulation Resistance | $IR > 1G\Omega$ | Chip Inductor Only Test Voltage: $100 \pm 10\%$ V for 30Sec |

5. **Derating Curve

For the ferrite chip bead which withstanding current over 1.5A, as operating temperature over 85°C , the derating current information is necessary to consider. For the detail derating of current, please refer to the Derated Current vs. perating Temperature curve.

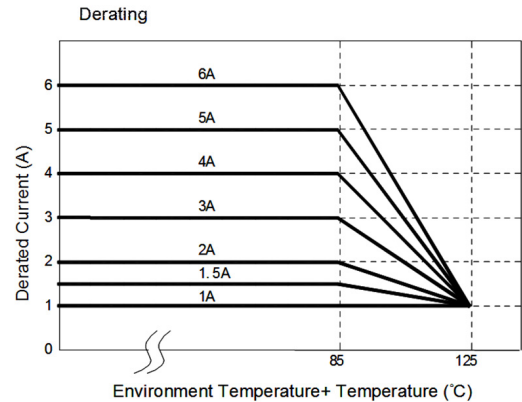

6. Soldering

Mildly activated rosin fluxes are preferred. The termination are suitable for re-flow soldering systems. If hand soldering cannot be avoided, the preferred technique is the utilization of hot air soldering tools. Note. If wave soldering is used, there will be some risk. Re-flow soldering temperatures below 240 degrees, there will be non-wetting risk.

CHIP FERRITE BEADS

6.1 Lead Free Solder re-flow

Recommended temperature profiles for lead free re-flow soldering in Figure 1. Reflow times: 3 times max



Figure 1

6.2 Solder Iron



Figure 2 (1 time max)

Products attachment with a soldering iron is discouraged due to the inherent process control limitations. If a soldering iron must be employed the following precautions are recommended. For Iron Soldering in Figure 2.

- Preheat circuit and products to 150°C
- 350°C tip temperature (max)
- Never contact the ceramic with the iron flip
- 1.00mm tip diameter (max)
- Use a 20 watt soldering iron with tip diameter of 1.0mm
- Limited soldering time to 4-5sec

6.3 Solder Volume

Accordingly increasing the solder volume, the mechanical stress to product is also increased. Exceeding solder volume may cause the failure of mechanical or electrical performance. Solder shall be used not to be exceed as shown in the right side:

Minimum fillet height = soldering thickness + 25% product height



CHIP FERRITE BEADS

7. Packaging Information

7.1 Reel Dimension

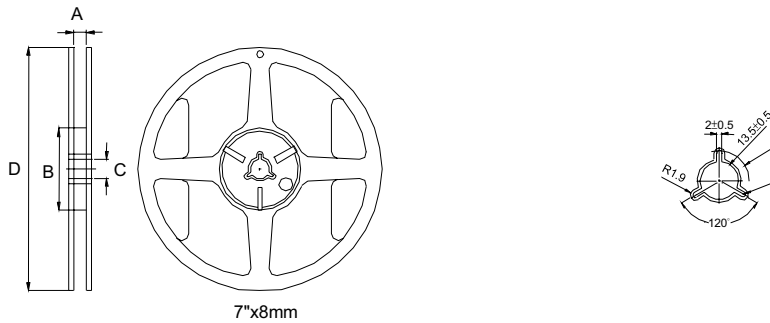

| Type | A(mm) | B(mm) | C(mm) | D(mm) |
|--------|----------|------------|--------|-------|
| 7"x8mm | 10.0±1.5 | 50 or more | 13±0.2 | 178±2 |

7.2 Qty/reel

| Chip Size | Chip/Reel | Reel Diameter |
|------------|-----------|---------------|
| PE-0402HFB | 10000 | 178 x 8mm |
| PE-0402FB | 10000 | 178 x 8mm |
| PE-0603FB | 4000 | 178 x 8mm |
| PE-0603HFB | 4000 | 178 x 8mm |
| PE-0603PFB | 4000 | 178 x 8mm |
| PE-0805FB | 4000 | 178 x 8mm |
| PE-0805PFB | 4000 | 178 x 8mm |
| PE-1206PFB | 3000 | 178 x 8mm |
| PE-1806PFB | 3000 | 178 x 8mm |

7.3 Tearing Off Force

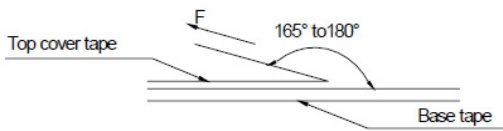

The force for tearing off cover tape is 15 to 60 grams in the arrow direction under the following conditions.

| Room Temp. (C) | Room Humidity (%) | Room atm (hPa) | Tearing Speed mm/min |
|----------------|-------------------|----------------|----------------------|
| 5~35 | 45~85 | 860~1060 | 300 |

CHIP FERRITE BEADS

Application Notice

*Storage Conditions

To maintain the solder ability of terminal electrodes:

1. Products meet IPC/JEDEC J-STD-020E standard-MSL, level 1.
2. Temperature and humidity conditions: Less than 40 °C and 60% RH.
3. Recommended products should be used within 12 months from the time of delivery.
4. The packaging material should be kept where no chlorine or sulfur exists in the air.

* Transportation

1. Products should be handled with care to avoid damage or contamination from perspiration and skin oils.
2. The use of tweezers or vacuum pick up is strongly recommended for individual components.
3. Bulk handling should ensure that abrasion and mechanical shock are minimized.

FERRITE BEAD EMI SUPPRESSOR SINGLE TYPE - FB SERIES FOR GENERAL SIGNAL LINE



- Ⓜ Signal Line EMI Suppression
- Ⓜ Monolithic inorganic material construction
- Ⓜ Various impedance and frequency application
- Ⓜ Industry Standard package

Electrical Specifications @ 25°C

| Part Number | Impedance (Ω) | Tolerance | Test Frequency (MHz) | DC Resistance (Ω) max. | Rated Current (mA) max. |
|----------------|---------------|-----------|----------------------|------------------------|-------------------------|
| PE-0402FB100XT | 0 ~ 15 | - | 100 | 0.03 | 1000 |
| PE-0402FB121ST | 120 | ±25% | 100 | 0.2 | 550 |
| PE-0402FB601ST | 600 | ±25% | 100 | 0.55 | 300 |
| PE-0402FB102ST | 1000 | ±25% | 100 | 0.58 | 300 |
| PE-0603FB121ST | 120 | ±25% | 100 | 0.18 | 500 |
| PE-0603FB221ST | 220 | ±25% | 100 | 0.25 | 500 |
| PE-0603FB601ST | 600 | ±25% | 100 | 0.38 | 500 |
| PE-0603FB102ST | 1000 | ±25% | 100 | 0.5 | 400 |
| PE-0805FB121ST | 120 | ±25% | 100 | 0.15 | 800 |
| PE-0805FB601ST | 600 | ±25% | 100 | 0.3 | 500 |
| PE-0805FB102ST | 1000 | ±25% | 100 | 0.4 | 500 |

Mechanicals

Application

PE-0402/0805FB

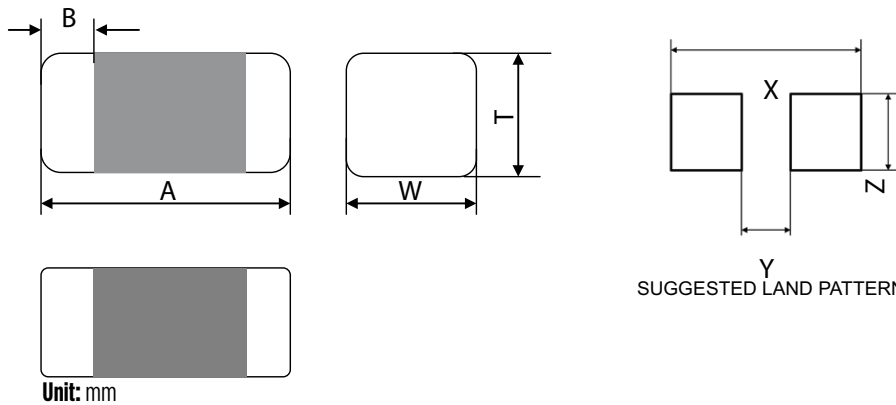

Dimension:

| Imperial Size | A | B | W | T | X | Y | Z |
|---------------|-----------------|----------|----------|----------|-------------|-------------|-----------|
| 0402 | 1.0±0.15 | 0.25±0.1 | 0.5±0.15 | 0.5±0.15 | 1.25 ~ 1.55 | 0.45 ~ 0.55 | 0.4~0.6 |
| 0603 | 1.6±0.15 | 0.3±0.2 | 0.8±0.15 | 0.8±0.15 | 1.8 ~ 2.4 | 0.6 ~ 0.8 | 0.6 ~ 0.8 |
| 0805 | 2.0(+0.3, -0.1) | 0.5±0.3 | 1.25±0.2 | 0.85±0.2 | 2.4 ~ 3.6 | 0.8 ~ 1.2 | 0.9 ~ 1.6 |

All units in mm

FERRITE BEAD EMI SUPPRESSOR SINGLE TYPE - FB SERIES FOR GENERAL SIGNAL LINE

Impedance Frequency Characteristics (Typical)

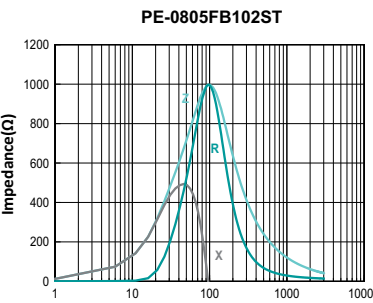
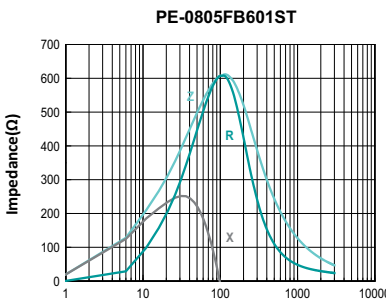
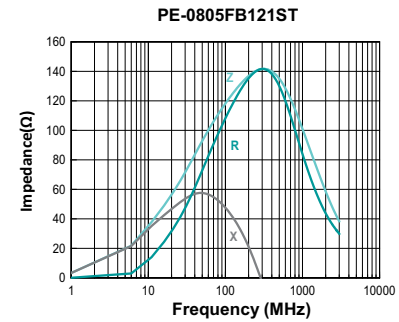
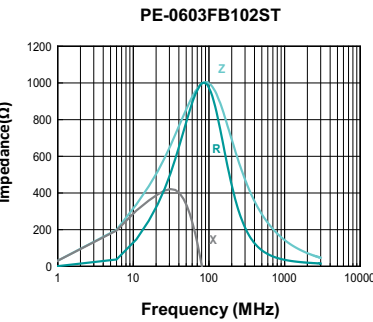
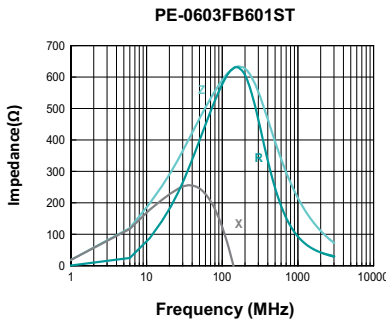
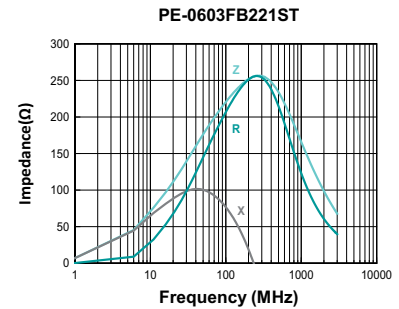
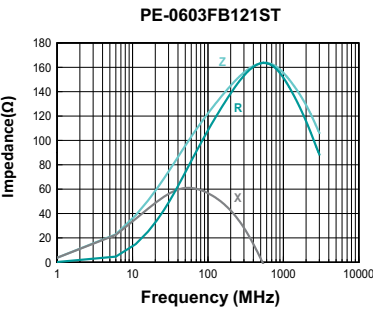
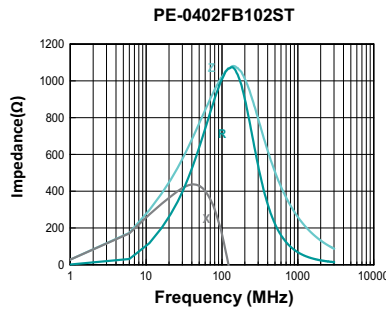
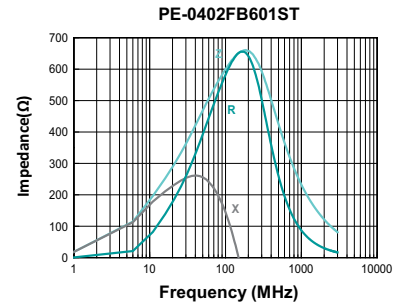
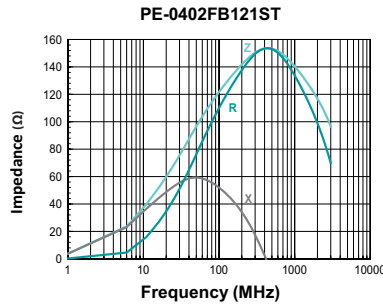
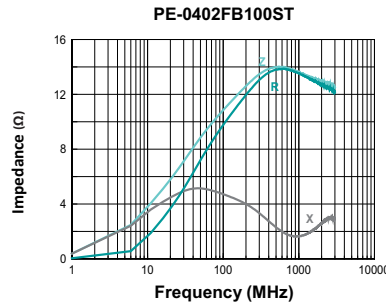

FERRITE BEAD EMI SUPPRESSOR SINGLE TYPE FOR HIGH FREQUENCY APPLICATION



- Ⓟ Signal Line EMI Suppression
- Ⓟ Monolithic inorganic material construction
- Ⓟ Various impedance and frequency application
- Ⓟ High Frequency Giga Hz Application
- Ⓟ Industry Standard package

| Electrical Specifications @ 25°C | | | | | | |
|----------------------------------|---------------|-----------|----------------------|-------------------------|------------------------|-------------------------|
| Part Number | Impedance (Ω) | Tolerance | Test Frequency (MHz) | Impedance (Ω) 1GHz mini | DC Resistance (Ω) max. | Rated Current (mA) max. |
| PE-0402HFB221ST | 220 | ±25% | 100 | 250 | 0.25 | 700 |
| PE-0402HFB601ST | 600 | ±25% | 100 | 840 | 0.85 | 300 |
| PE-0402HFB102ST | 1000 | ±25% | 100 | 1200 | 1.25 | 250 |
| PE-0402HFB102STA | 1000 | ±25% | 100 | 900 | 1.1 | 250 |
| PE-0402HFB152ST | 1500 | ±25% | 100 | - | 1.50 | 200 |
| PE-0402HFB182ST | 1800 | ±25% | 100 | - | 2.0 | 200 |
| PE-0603HFB601ST | 600 | ±25% | 100 | 450 | 0.35 | 500 |
| PE-0603HFB102ST | 1000 | ±25% | 100 | 750 | 1.6 | 100 |
| | | ±25% | 100 | 750 | 1.6 | 100 |

Mechanical

PE-XXXXHFB



Unit: mm

PCB LAYOUT

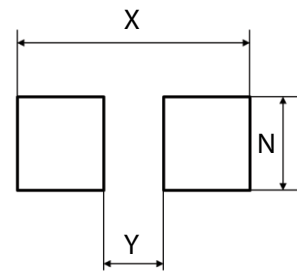

SUGGESTED LAND PATTERN

Dimension:

| Imperial Size | A | B | W | T | X | Y | Z |
|---------------|----------|----------|----------|----------|-----------|-----------|-----------|
| 0402 | 1.0±0.15 | 0.25±0.1 | 0.5±0.15 | 0.5±0.15 | 1.25~1.55 | 0.45~0.55 | 0.45~0.55 |
| 0603 | 1.6±0.15 | 0.3±0.2 | 0.8±0.15 | 0.85±0.2 | 1.8~2.4 | 0.6~0.8 | 0.6~0.8 |

All units in mm

FERRITE BEAD EMI SUPPRESSOR SINGLE TYPE FOR HIGH FREQUENCY APPLICATION

Impedance Frequency Characteristics (Typical)



FERRITE BEAD EMI SUPPRESSOR SINGLE TYPE FOR POWER LINE APPLICATION



- Ⓢ Power Line EMI Suppression
- Ⓢ Monolithic inorganic material construction
- Ⓢ Various impedance and frequency application
- Ⓢ Industry Standard package

Electrical Specifications @ 25°C

| Part Number | Impedance (Ω) | Tolerance | Test Frequency (MHz) | DC Resistance (Ω) max. | Rated Current (mA) max. |
|-----------------|---------------|-----------|----------------------|------------------------|-------------------------|
| PE-0603PFB121ST | 120 | ±25% | 100 | 0.05 | 2000 |
| PE-0603PFB181ST | 180 | ±25% | 100 | 0.09 | 1500 |
| PE-0603PFB221ST | 220 | ±25% | 100 | 0.05 | 2200 |
| PE-0603PFB471ST | 470 | ±25% | 100 | 0.2 | 1000 |
| PE-0603PFB600ST | 60 | ±25% | 100 | 0.04 | 3000 |
| PE-0603PFB300ST | 30 | ±25% | 100 | 0.02 | 5000 |
| PE-0603PFB260ST | 26 | ±25% | 100 | 0.01 | 6000 |
| PE-0805PFB121ST | 120 | ±25% | 100 | 0.03 | 3000 |
| PE-0805PFB221ST | 220 | ±25% | 100 | 0.07 | 2000 |
| PE-0805PFB331ST | 330 | ±25% | 100 | 0.1 | 1500 |
| PE-0805PFB600ST | 60 | ±25% | 100 | 0.025 | 3000 |
| PE-1206PFB121ST | 120 | ±25% | 100 | 0.03 | 3000 |
| PE-1206PFB500ST | 50 | ±25% | 100 | 0.03 | 3000 |
| PE-1206PFB601ST | 600 | ±25% | 100 | 0.1 | 2000 |
| PE-1806PFB600ST | 60 | ±25% | 100 | 0.01 | 6000 |
| PE-1806PFB720ST | 72 | ±25% | 100 | 0.04 | 6000 |

Mechanical

PE-XXXXPFB

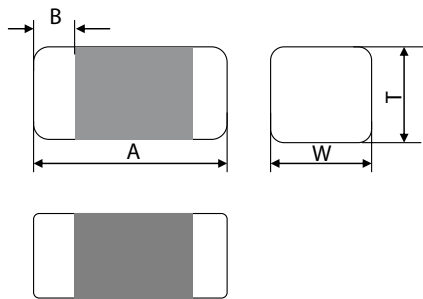

PCB LAYOUT

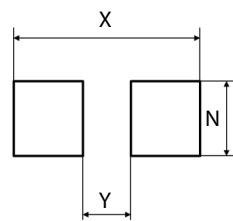

SUGGESTED LAND PATTERN

| Imperial Size | A | B | W | T | X | Y | Z |
|---------------|------------------|---------|----------|----------|---------|---------|---------|
| 0603 | 1.6±0.15 | 0.3±0.2 | 0.8±0.15 | 0.85±0.2 | 1.8~2.4 | 0.6~0.8 | 0.6~0.8 |
| 0805 | 2.0 (+0.3, -0.1) | 0.5±0.3 | 1.25±0.2 | 0.85±0.2 | 2.4~3.6 | 0.8~1.2 | 0.9~1.6 |
| 1206 | 3.2±0.2 | 0.5±0.3 | 1.6±0.2 | 0.85±0.2 | 3.8~5.5 | 1.8~2.5 | 1.2~2.0 |
| 1806 | 4.5±0.2 | 0.5±0.3 | 1.6±0.2 | 1.6±0.2 | 5.3~6.7 | 2.4~3.2 | 0.9~1.6 |

All units in mm

FERRITE BEAD EMI SUPPRESSOR SINGLE TYPE FOR POWER LINE APPLICATION

Impedance Frequency Characteristics (Typical)

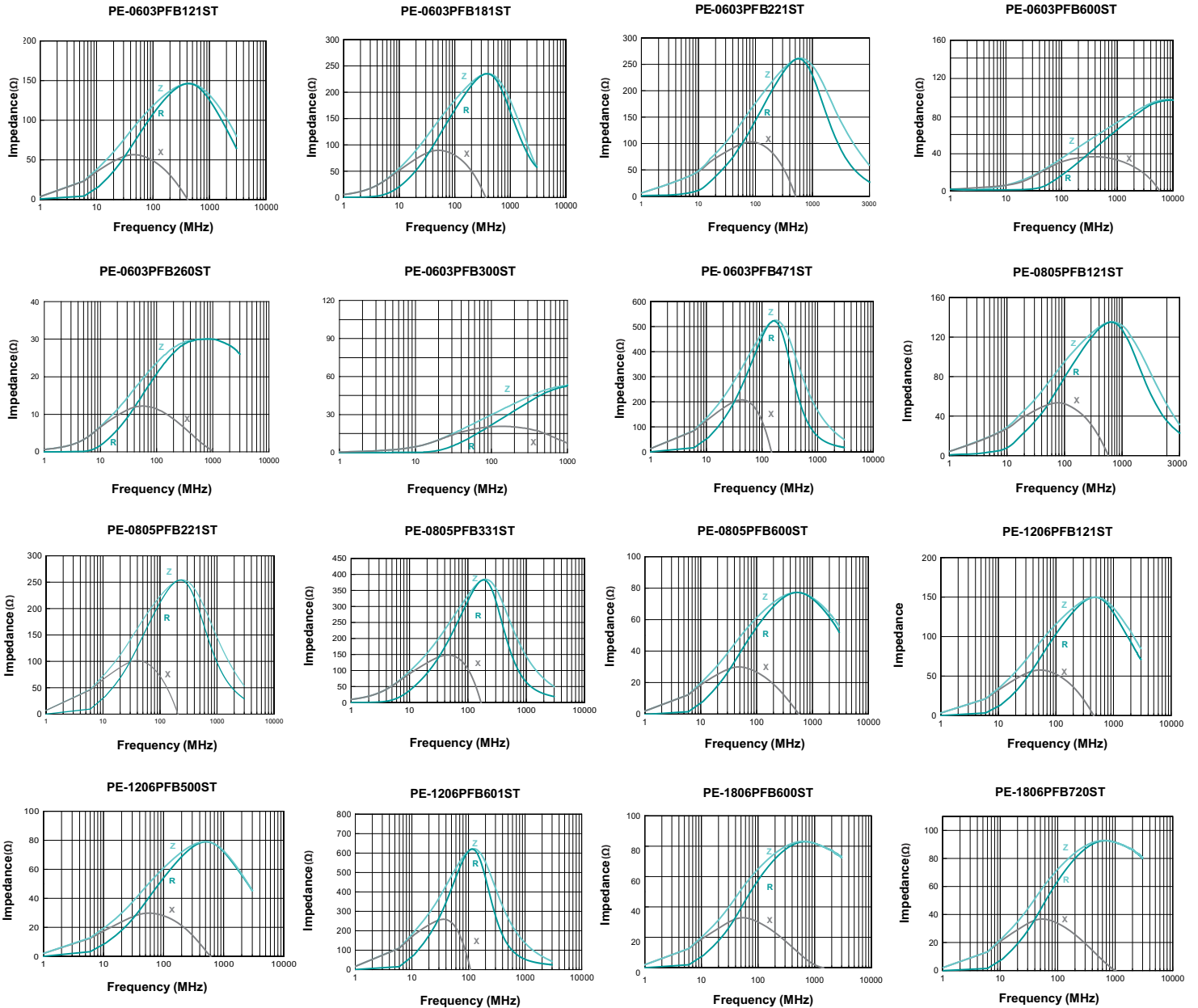

For More Information

Americas - prodinfonetworkamericas@pulseelectronics.com | Europe - comms-Apps-Europe@pulseelectronics.com | Asia - prodinfonetworkapac@pulseelectronics.com

Performance warranty of products offered on this data sheet is limited to the parameters specified. Data is subject to change without notice. Other brand and product names mentioned herein may be trademarks or registered trademarks of their respective owners. © Copyright, 2020, Pulse Electronics, Inc. All rights reserved.