



*Quality Products. Service Excellence.*

## Low Voltage PCB Mount - Low Profile 162-164 Series

### Features



- 20 output voltages to choose from (5 - 120VAC R.M.S.)
- Six VA size models available from - 1.1 to 36VA
- Both series operate on 50/60 Hz current
- Low profile, split bobbin design.
- Dual winding secondaries, non-concentrically wound
- Units are designed so that all windings must be used
- Low primary to secondary coupling - no electrostatic shield required.
- Choice of economical single primary 115V (164 series) or universal dual primary 115/230V (162 series) - either model 50/60 Hz operation.
- High insulation - Hipot of 2,500V RMS.
- Class B insulation - 130 degrees C.
- No mounting hardware required on 1.1 and 2.4 VA sizes, two hole mounting on 6, 12 and 20VA sizes, four hole mounting on 36VA size (mounting screws not provided). P.C. board mount with industry standard pin spacing.
- c UL us recognized





**Single Primary  
164 Series**

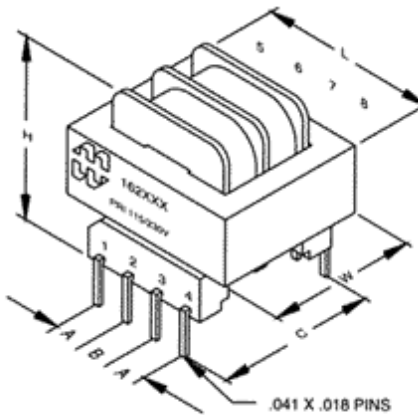

**Dual Primary  
162 Series**

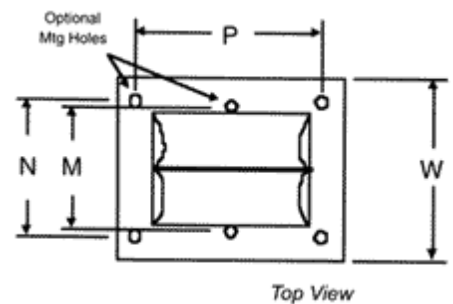
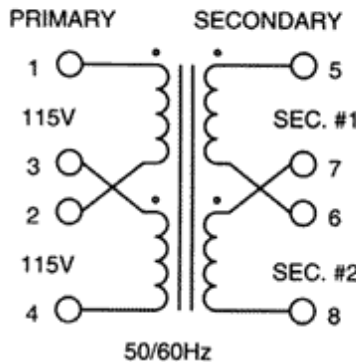
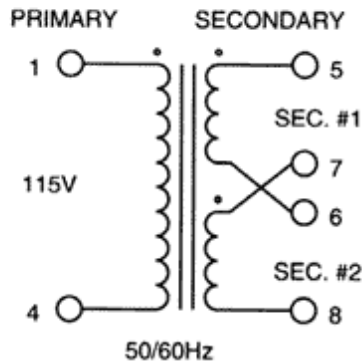

Part No Single Primary 115V	Part No Dual Primary 115/230V	Size VA	Series	Secondary (RMS) Parallel
164D10	162D10	1.1	10V C.T. @ .11A	5V @ .22A
164E10	162E10	2.4	10V C.T. @ .25A	5V @ .5A
164F10	162F10	6	10V C.T. @ .6A	5V @ 1.2A
164G10	162G10	12	10V C.T. @ 1.2A	5V @ 2.4A
164H10	162H10	20	10V C.T. @ 2A	5V @ 4.0A
164J10	162J10	36	10V C.T. @ 3.6A	5V @ 7.2A
164D12	162D12	1.1	12.6V C.T. @ .09A	6.3V @ .18A
164E12	162E12	2.4	12.6V C.T. @ .2A	6.3V @ .4A
164F12	162F12	6	12.6V C.T. @ .5A	6.3V @ 1.0A
164G12	162G12	12	12.6V C.T. @ 1.0A	6.3V @ 2.0A
164H12	162H12	20	12.6V C.T. @ 1.6A	6.3V @ 3.2A
164J12	162J12	36	12.6V C.T. @ 2.85A	6.3V @ 5.7A
164D16	162D16	1.1	16V C.T. @ .07A	8V @ .14A
164E16	162E16	2.4	16V C.T. @ .15A	8V @ .3A
164F16	162F16	6	16V C.T. @ .4A	8V @ .8A
164G16	162G16	12	16V C.T. @ .8A	8V @ 1.6A
164H16	162H16	20	16V C.T. @ 1.25A	8V @ 2.5A
164J16	162J16	36	16V C.T. @ 2.25A	8V @ 4.5A
164D20	162D20	1.1	20V C.T. @ .055A	10V @ .11A
164E20	162E20	2.4	20V C.T. @ .12A	10V @ .24A
164F20	162F20	6	20V C.T. @ .3A	10V @ .6A
164G20	162G20	12	20V C.T. @ .6A	10V @ 1.2A
164H20	162H20	20	20V C.T. @ 1A	10V @ 2.0A
164J20	162J20	36	20V C.T. @ 1.8A	10V @ 3.6A
164D24	162D24	1.1	24V C.T. @ .045A	12V @ .09A
164E24	162E24	2.4	24V C.T. @ .1A	12V @ .2A

Part No Single Primary 115V	Part No Dual Primary 115/230V	Size VA	Secondary (RMS)		
			Series	Parallel	
164F24	162F24	6	24V C.T. @ .25A	12V @ .5A	
164G24	162G24	12	24V C.T. @ .5A	12V @ 1.0A	
164H24	162H24	20	24V C.T. @ .8A	12V @ 1.6A	
164J24	162J24	36	24V C.T. @ 1.5A	12V @ 3.0A	
164D28	162D28	1.1	28V C.T. @ .04A	14V @ .08A	
164E28	162E28	2.4	28V C.T. @ .085A	14V @ .17A	
164F28	162F28	6	28V C.T. @ .2A	14V @ .4A	
164G28	162G28	12	28V C.T. @ .42A	14V @ .84A	
164H28	162H28	20	28V C.T. @ .7A	14V @ 1.4A	
164J28	162J28	36	28V C.T. @ 1.3A	14V @ 2.6A	
164D36	162D36	1.1	36V C.T. @ .03A	18V @ .06A	
164E36	162E36	2.4	36V C.T. @ .065A	18V @ .13A	
164F36	162F36	6	36V C.T. @ .17A	18V @ .34A	
164G36	162G36	12	36V C.T. @ .35A	18V @ .7A	
164H36	162H36	20	36V C.T. @ .55A	18V @ 1.1A	
164J36	162J36	36	36V C.T. @ 1A	18V @ 2.0A	
164D48	162D48	1.1	48V C.T. @ .023A	24V @ .046A	
164E48	162E48	2.4	48V C.T. @ .05A	24V @ .1A	
164F48	162F48	6	48V C.T. @ .125A	24V @ .25A	
164G48	162G48	12	48V C.T. @ .25A	24V @ .5A	
164H48	162H48	20	48V C.T. @ .4A	24V @ .8A	
164J48	162J48	36	48V C.T. @ .75A	24V @ 1.5A	
164D56	162D56	1.1	56V C.T. @ .02A	28V @ .04A	
164E56	162E56	2.4	56V C.T. @ .045A	28V @ .09A	
164F56	162F56	6	56V C.T. @ .11A	28V @ .22A	
164G56	162G56	12	56V C.T. @ .22A	28V @ .44A	
164H56	162H56	20	56V C.T. @ .35A	28V @ .7A	
164J56	162J56	36	56V C.T. @ .65A	28V @ 1.3A	
164D120	162D120	1.1	120V C.T. @ .01A	60V @ .02A	
164E120	162E120	2.4	120V C.T. @ .02A	60V @ .04A	
164F120	162F120	6	120V C.T. @ .05A	60V @ .1A	
164G120	162G120	12	120V C.T. @ .1A	60V @ .2A	
164H120	162H120	20	120V C.T. @ .16A	60V @ .32A	
164J120	162J120	36	120V C.T. @ .3A	60V @ .6A	

## Mechanical & Schematic Data

(VA) Size	Part Number Letter	Dimensions										Mounting Screw	Weight lbs.
		L	W	H	A	B	C	M	N	P			
1.1	D	1.38	1.13	15/16	0.25	0.25	1.2	-	-	-	-	0.17	
2.4	E	1.38	1.13	1.19	0.25	0.25	1.2	-	-	-	-	0.25	
6	F	1.63	1.31	1.31	0.25	0.35	1.28	1.06	-	-	#4	0.44	
12	G	1.88	1.56	1.50	0.30	0.40	1.41	1.25	-	-	#4	0.7	
20	H	2.25	1.88	1.44	0.30	0.40	1.6	1.5	-	-	#4	0.8	
36	J	2.63	2.19	1.56	0.40	0.40	1.85	-	1.75	2.19	#6	1.1	

Data subject to change without notice

© 2020. Hammond Manufacturing Ltd. All rights reserved.

