

IRGR3B60KD2PbF

INSULATED GATE BIPOLAR TRANSISTOR WITH ULTRAFAST SOFT RECOVERY DIODE

Features

- Low VCE (on) Non Punch Through IGBT Technology.
- Low Diode VF.
- 10µs Short Circuit Capability.
- Square RBSOA.
- Ultrasoft Diode Reverse Recovery Characteristics.
- Positive VCE (on) Temperature Coefficient.
- Lead-Free

Benefits

- Benchmark Efficiency for Motor Control.
- Rugged Transient Performance.
- Low EMI.
- Excellent Current Sharing in Parallel Operation.

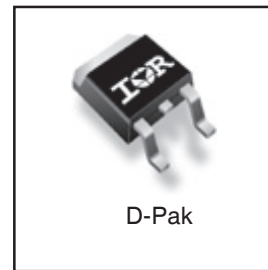
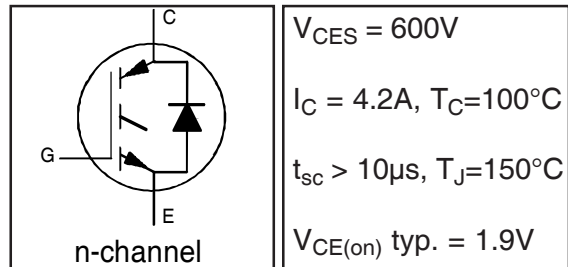

Absolute Maximum Ratings

	Parameter	Max.	Units
V _{CEs}	Collector-to-Emitter Voltage	600	V
I _C @ T _C = 25°C	Continuous Collector Current	7.8	A
I _C @ T _C = 100°C	Continuous Collector Current	4.2	
I _{CM}	Pulse Collector Current (Ref.Fig.C.T.5)	15.6	
I _{LM}	Clamped Inductive Load current ①	15.6	
I _F @ T _C = 25°C	Diode Continuous Forward Current	6.0	
I _F @ T _C = 100°C	Diode Continuous Forward Current	3.2	
I _{FM}	Diode Maximum Forward Current	15.6	
V _{GE}	Gate-to-Emitter Voltage	±20	V
P _D @ T _C = 25°C	Maximum Power Dissipation	52	W
P _D @ T _C = 100°C	Maximum Power Dissipation	21	
T _J	Operating Junction and	-55 to +150	°C
T _{STG}	Storage Temperature Range		
	Soldering Temperature Range, for 10 sec.	300 (0.063 in. (1.6mm) from case)	

Thermal / Mechanical Characteristics

	Parameter	Min.	Typ.	Max.	Units
R _{θJC}	Junction-to-Case- IGBT	—	—	2.4	°C/W
R _{θJC}	Junction-to-Case- Diode	—	—	8.8	
R _{θJA}	Junction-to-Ambient, (PCB Mount) ②	—	—	50	
Wt	Weight	—	0.3	—	g

IRGR3B60KD2PbF

International
IR Rectifier

Electrical Characteristics @ T_J = 25°C (unless otherwise specified)

	Parameter	Min.	Typ.	Max.	Units	Conditions	Ref.Fig.
V _{(BR)CES}	Collector-to-Emitter Breakdown Voltage	600	—	—	V	V _{GE} = 0V, I _C = 500μA	
ΔV _{(BR)CES} /ΔT _J	Temperature Coeff. of Breakdown Voltage	—	0.32	—	V/°C	V _{GE} = 0V, I _C = 1mA (25°C-150°C)	
V _{CE(on)}	Collector-to-Emitter Voltage	—	1.9	2.4	V	I _C = 3.0A, V _{GE} = 15V	5,6,7
		—	2.2	2.6		I _C = 3.0A, V _{GE} = 15V, T _J = 150°C	9,10,11
V _{GE(th)}	Gate Threshold Voltage	3.5	4.5	5.5		V _{CE} = V _{GE} , I _C = 250μA	9,10,11
ΔV _{GE(th)} /ΔT _J	Threshold Voltage temp. coefficient	—	-8.5	—	mV/°C	V _{CE} = V _{GE} , I _C = 1mA (25°C-150°C)	12
g _{fe}	Forward Transconductance	—	1.9	—	S	V _{CE} = 50V, I _C = 3.0A, PW = 80μs	
I _{CES}	Zero Gate Voltage Collector Current	—	1.0	150	μA	V _{GE} = 0V, V _{CE} = 600V	
		—	200	500		V _{GE} = 0V, V _{CE} = 600V, T _J = 150°C	
V _{FM}	Diode Forward Voltage Drop	—	1.5	1.8	V	I _F = 3.0A, V _{GE} = 0V	8
		—	1.5	1.8		I _F = 3.0A, V _{GE} = 0V, T _J = 150°C	
I _{GES}	Gate-to-Emitter Leakage Current	—	—	±100	nA	V _{GE} = ±20V, V _{CE} = 0V	

Switching Characteristics @ T_J = 25°C (unless otherwise specified)

	Parameter	Min.	Typ.	Max.	Units	Conditions	Ref.Fig.
Q _g	Total Gate Charge (turn-on)	—	13	20	nC	I _C = 3.0A	23
Q _{ge}	Gate-to-Emitter Charge (turn-on)	—	1.5	2.3		V _{CC} = 400V	CT1
Q _{gc}	Gate-to-Collector Charge (turn-on)	—	6.6	9.9		V _{GE} = 15V	
E _{on}	Turn-On Switching Loss	—	62	75	μJ	I _C = 3.0A, V _{CC} = 400V	CT4
E _{off}	Turn-Off Switching Loss	—	39	50		V _{GE} = 15V, R _G = 100Ω, L = 2.5mH	
E _{tot}	Total Switching Loss	—	100	120		T _J = 25°C ③	
t _{d(on)}	Turn-On delay time	—	18	22	ns	I _C = 3.0A, V _{CC} = 400V	CT4
t _r	Rise time	—	15	21		V _{GE} = 15V, R _G = 100Ω, L = 2.5mH	
t _{d(off)}	Turn-Off delay time	—	110	120		T _J = 25°C	
t _f	Fall time	—	68	80			
		—	—	—			
E _{on}	Turn-On Switching Loss	—	91	100	μJ	I _C = 3.0A, V _{CC} = 400V	CT4
E _{off}	Turn-Off Switching Loss	—	98	140		V _{GE} = 15V, R _G = 100Ω, L = 2.5mH	13,15
E _{tot}	Total Switching Loss	—	190	230		T _J = 150°C ③	WF1,WF2
t _{d(on)}	Turn-On delay time	—	18	22	ns	I _C = 3.0A, V _{CC} = 400V	14,16
t _r	Rise time	—	17	22		V _{GE} = 15V, R _G = 100Ω, L = 2.5mH	CT4
t _{d(off)}	Turn-Off delay time	—	120	140		T _J = 150°C	WF1
t _f	Fall time	—	91	105			WF2
C _{ies}	Input Capacitance	—	190	—	pF	V _{GE} = 0V	22
C _{oes}	Output Capacitance	—	23	—		V _{CC} = 30V	
C _{res}	Reverse Transfer Capacitance	—	6.6	—		f = 1.0MHz	
RBSOA	Reverse Bias Safe Operating Area	FULL SQUARE				T _J = 150°C, I _C = 15.6A, V _p = 600V V _{CC} =500V, V _{GE} =+15V to 0V, R _G = 100Ω	4 CT2
SCSOA	Short Circuit Safe Operating Area	10	—	—	μs	T _J = 150°C, V _p = 600V, R _G = 100Ω V _{CC} =360V, V _{GE} = +15V to 0V	CT3 WF4
E _{rec}	Reverse Recovery Energy of the Diode	—	38	44	μJ	T _J = 150°C	17,18,19
t _{rr}	Diode Reverse Recovery Time	—	77	84	ns	V _{CC} = 400V, I _F = 3.0A, L = 2.5mH	20,21
I _{rr}	Diode Peak Reverse Recovery Current	—	4.8	5.3	A	V _{GE} = 15V, R _G = 100Ω	CT4,WF3

① V_{CC} = 80% (V_{CES}), V_{GE} = 15V, L = 100μH, R_G = 100Ω.

③ Energy losses include "tail" and diode reverse recovery.

② When mounted on 1" square PCB (FR-4 or G-10 Material) . For recommended footprint and soldering techniques refer to application note #AN-994.

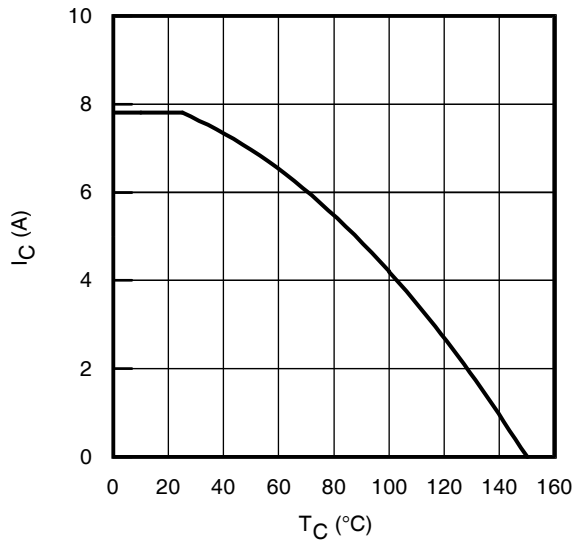

Fig. 1 - Maximum DC Collector Current vs. Case Temperature

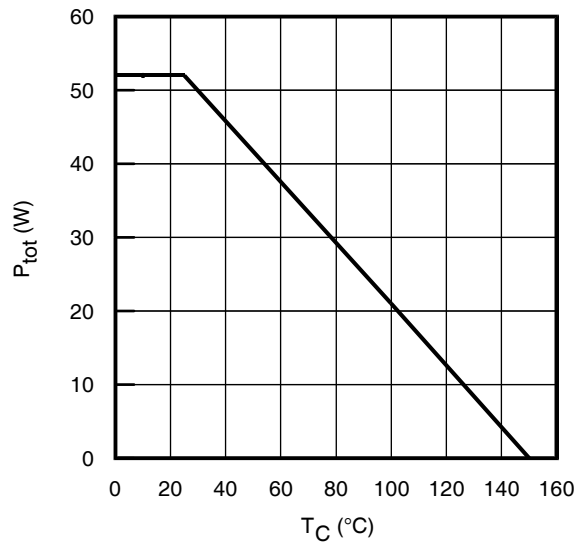

Fig. 2 - Power Dissipation vs. Case Temperature

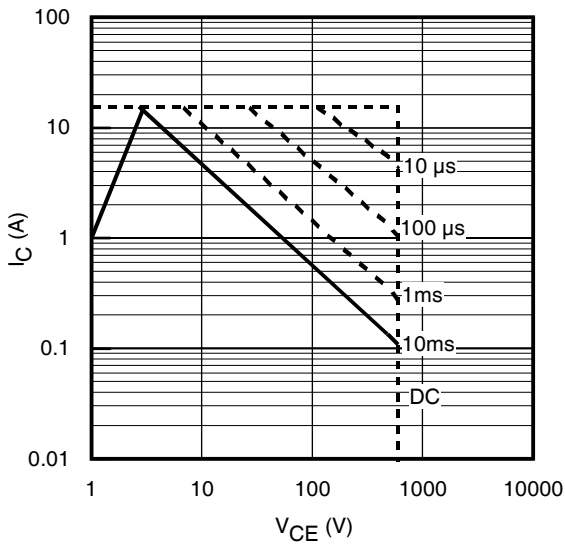

Fig. 3 - Forward SOA
 $T_C = 25^{\circ}C$; $T_J \leq 150^{\circ}C$

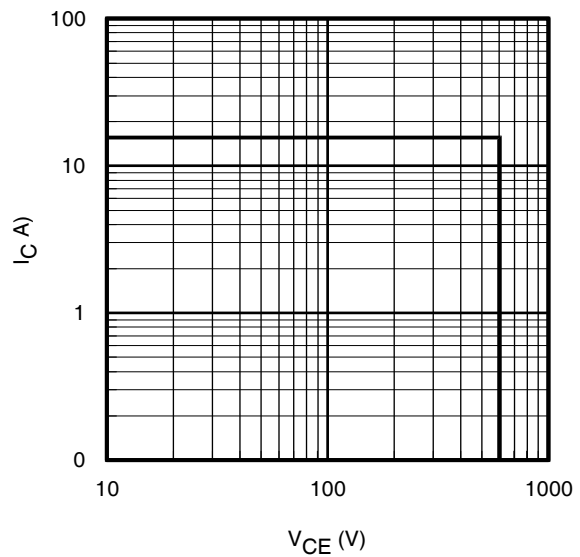

Fig. 4 - Reverse Bias SOA
 $T_J = 150^{\circ}C$; $V_{GE} = 15V$

IRGR3B60KD2PbF

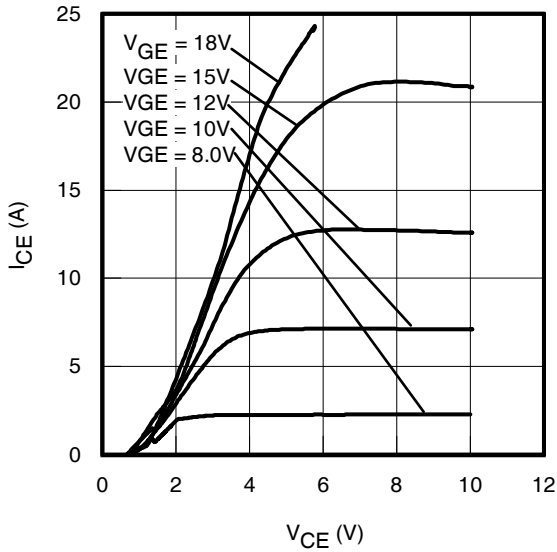

Fig. 5 - Typ. IGBT Output Characteristics
 $T_J = -40^\circ\text{C}$; $t_p = 80\mu\text{s}$

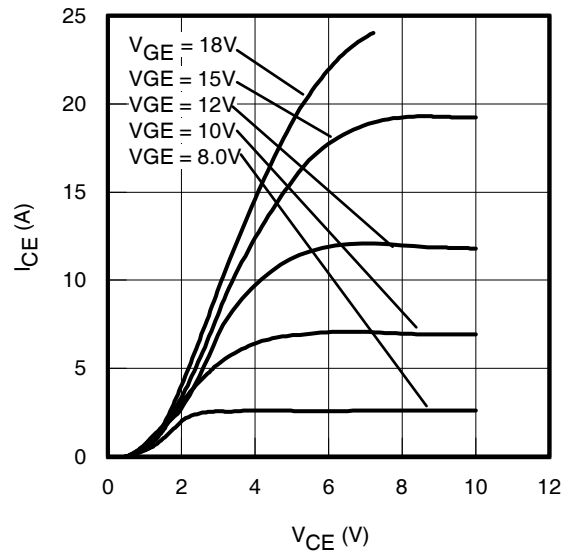

Fig. 6 - Typ. IGBT Output Characteristics
 $T_J = 25^\circ\text{C}$; $t_p = 80\mu\text{s}$

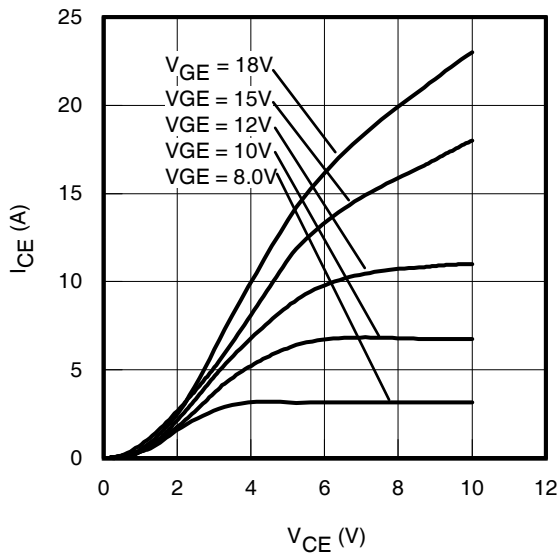

Fig. 7 - Typ. IGBT Output Characteristics
 $T_J = 150^\circ\text{C}$; $t_p = 80\mu\text{s}$

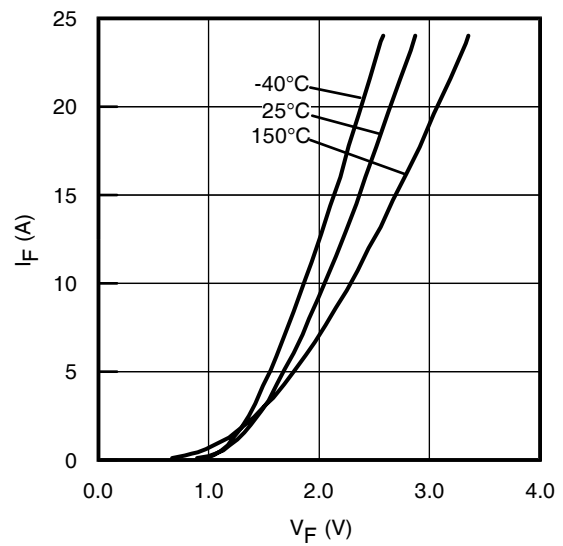

Fig. 8 - Typ. Diode Forward Characteristics
 $t_p = 80\mu\text{s}$

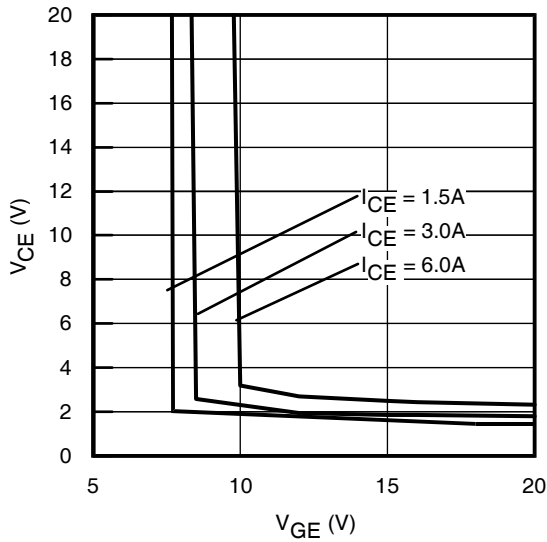

Fig. 9 - Typical V_{CE} vs. V_{GE}
 $T_J = -40^\circ\text{C}$

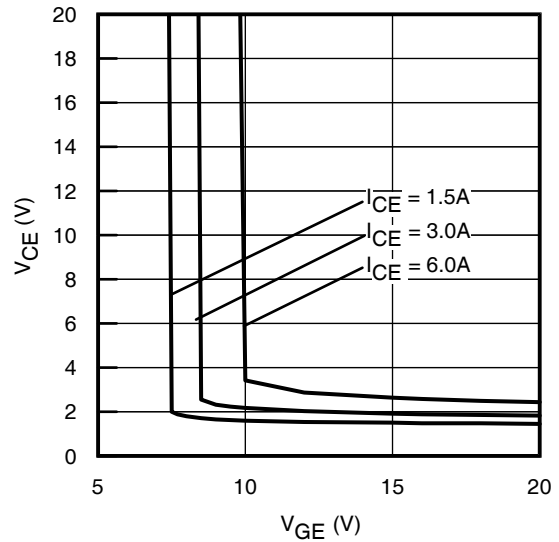

Fig. 10 - Typical V_{CE} vs. V_{GE}
 $T_J = 25^\circ\text{C}$

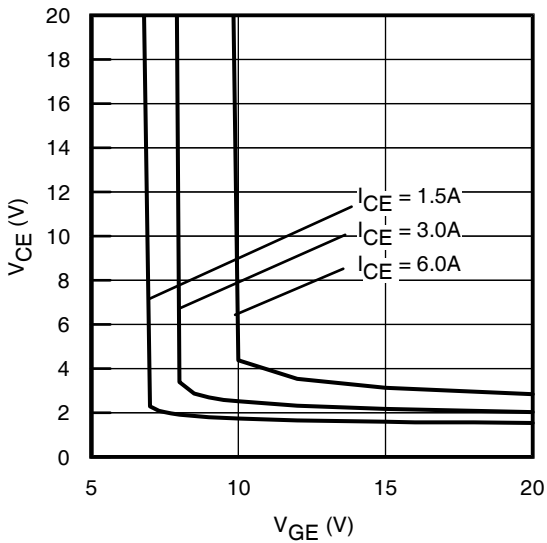

Fig. 11 - Typical V_{CE} vs. V_{GE}
 $T_J = 150^\circ\text{C}$

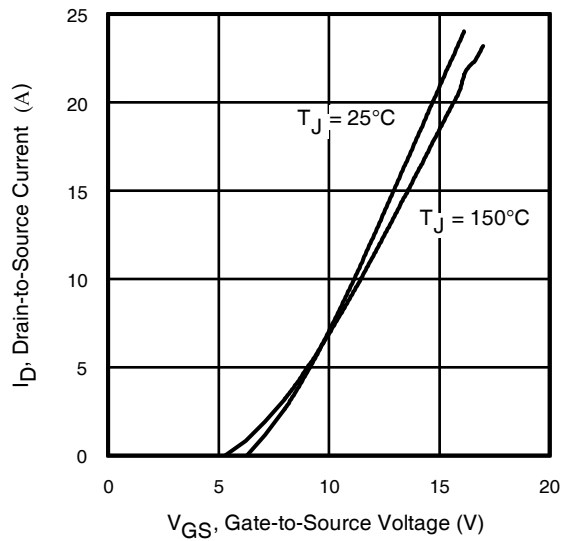

Fig. 12 - Typ. Transfer Characteristics
 $V_{CE} = 50\text{V}$; $t_p = 10\mu\text{s}$

IRGR3B60KD2PbF

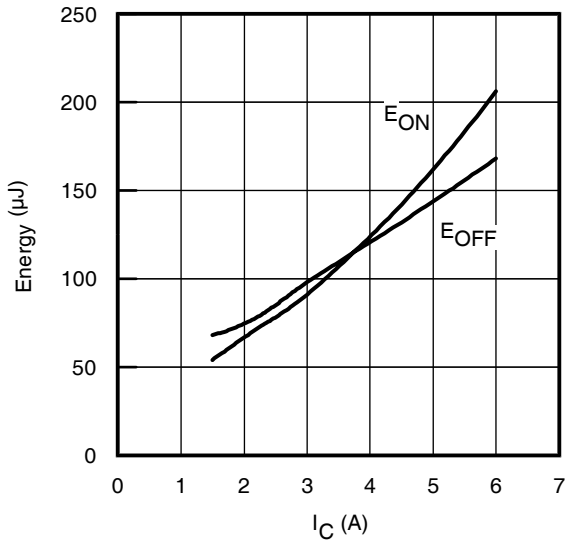

Fig. 13 - Typ. Energy Loss vs. I_C
 $T_J = 150^\circ\text{C}$; $L = 2.5\text{mH}$; $V_{CE} = 400\text{V}$
 $R_G = 100\Omega$; $V_{GE} = 15\text{V}$

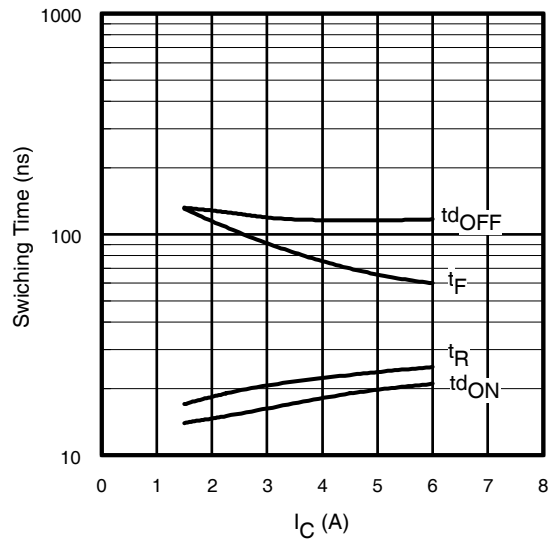

Fig. 14 - Typ. Switching Time vs. I_C
 $T_J = 150^\circ\text{C}$; $L = 2.5\text{mH}$; $V_{CE} = 400\text{V}$
 $R_G = 100\Omega$; $V_{GE} = 15\text{V}$

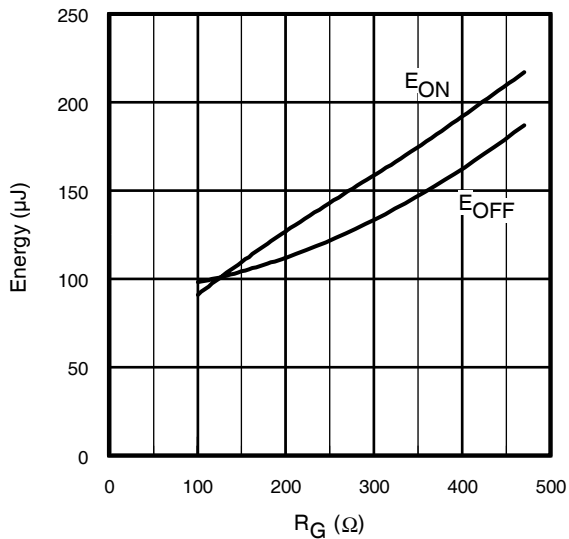

Fig. 15 - Typ. Energy Loss vs. R_G
 $T_J = 150^\circ\text{C}$; $L = 2.5\text{mH}$; $V_{CE} = 400\text{V}$
 $I_{CE} = 3.0\text{A}$; $V_{GE} = 15\text{V}$

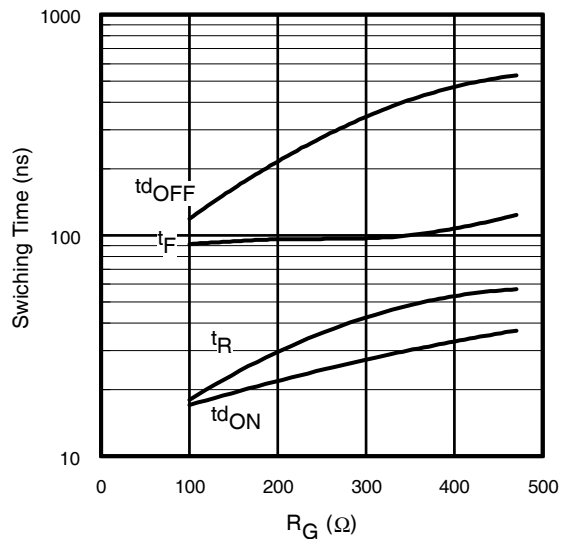

Fig. 16 - Typ. Switching Time vs. R_G
 $T_J = 150^\circ\text{C}$; $L = 2.5\text{mH}$; $V_{CE} = 400\text{V}$
 $I_{CE} = 3.0\text{A}$; $V_{GE} = 15\text{V}$

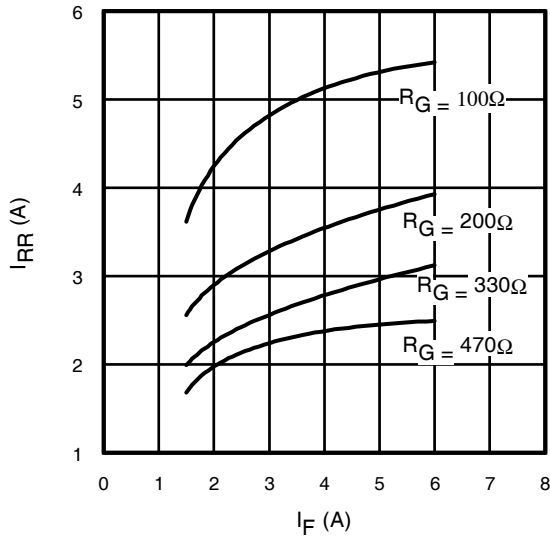

Fig. 17 - Typical Diode I_{RR} vs. I_F
 $T_J = 150^\circ\text{C}$

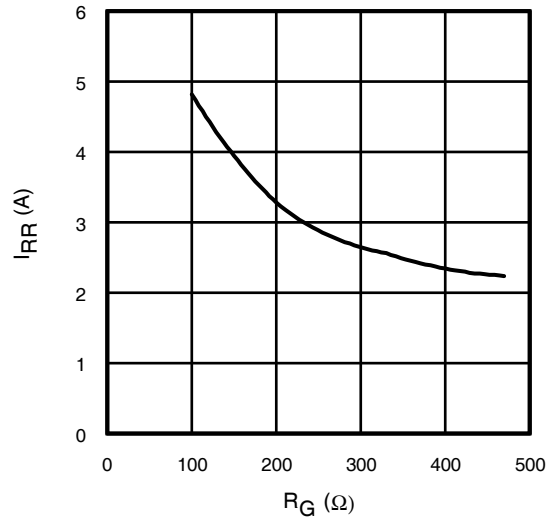

Fig. 18 - Typical Diode I_{RR} vs. R_G
 $T_J = 150^\circ\text{C}; I_F = 3.0\text{A}$

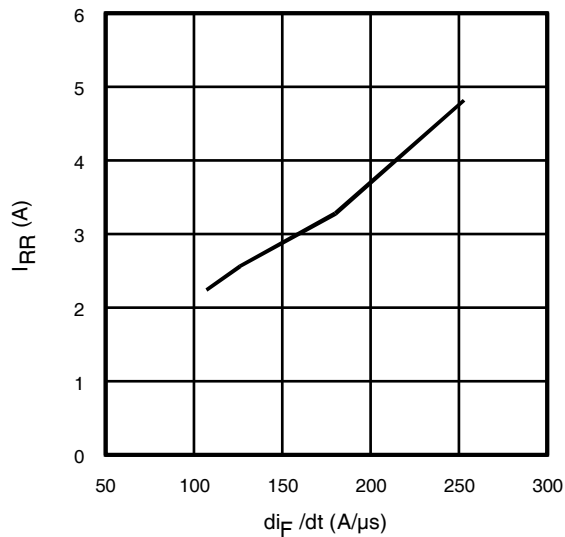

Fig. 19- Typical Diode I_{RR} vs. di_F/dt
 $V_{CC} = 400\text{V}; V_{GE} = 15\text{V};$
 $I_F = 3.0\text{A}; T_J = 150^\circ\text{C}$

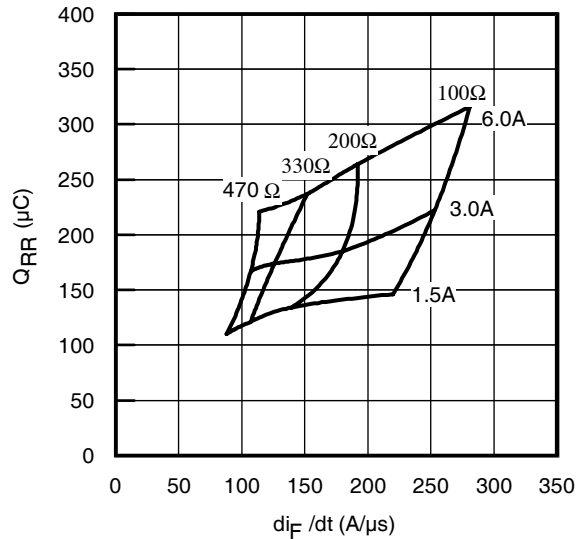

Fig. 20 - Typical Diode Q_{RR}
 $V_{CC} = 400\text{V}; V_{GE} = 15\text{V}; T_J = 150^\circ\text{C}$

IRGR3B60KD2PbF

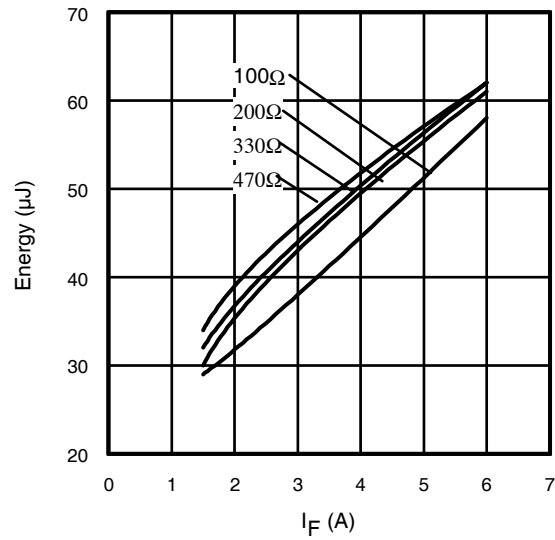

Fig. 21 - Typical Diode E_{RR} vs. I_F
 $T_J = 150^\circ\text{C}$

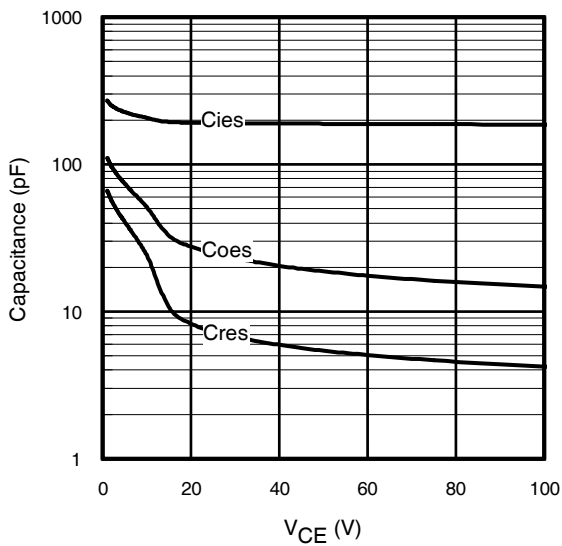

Fig. 22- Typ. Capacitance vs. V_{CE}
 $V_{GE} = 0\text{V}$; $f = 1\text{MHz}$

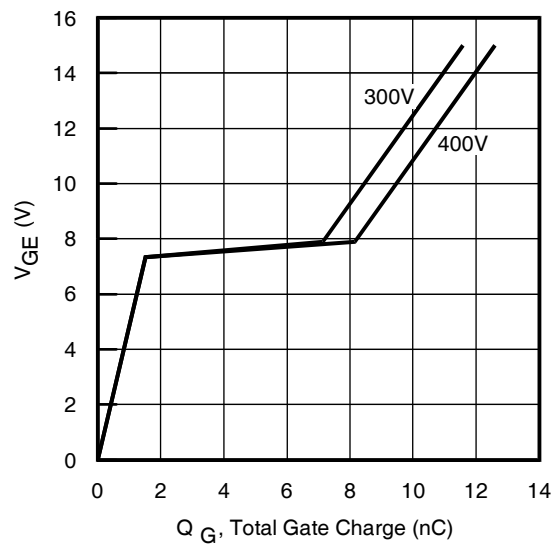

Fig. 23 - Typical Gate Charge vs. V_{GE}
 $I_{CE} = 3.0\text{A}$; $L = 600\mu\text{H}$

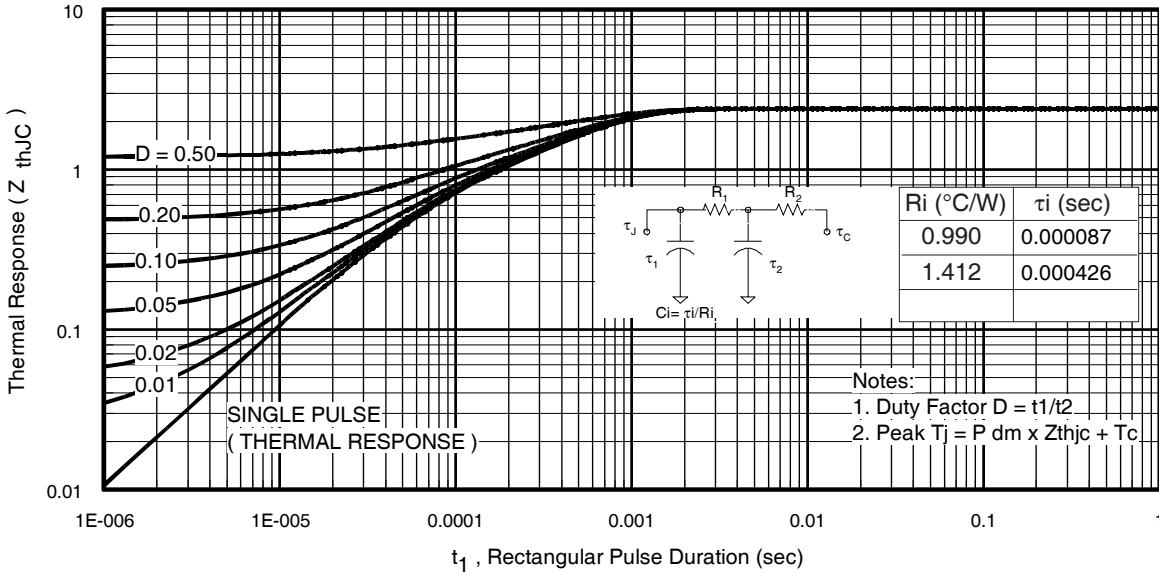

Fig 24. Maximum Transient Thermal Impedance, Junction-to-Case (IGBT)

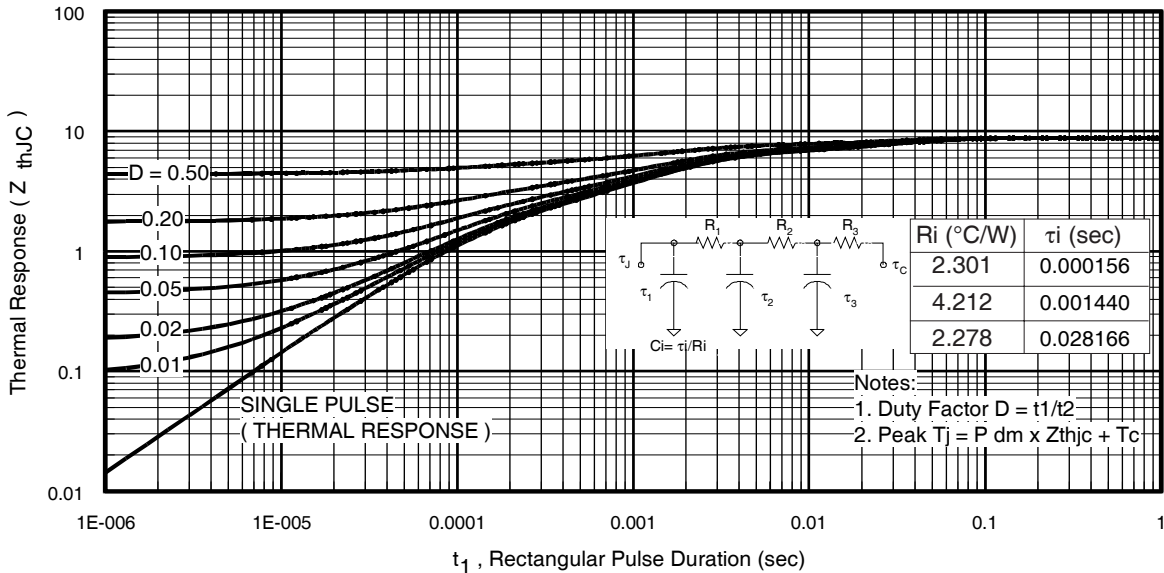

Fig 25. Maximum Transient Thermal Impedance, Junction-to-Case (DIODE)

IRGR3B60KD2PbF

International
IR Rectifier

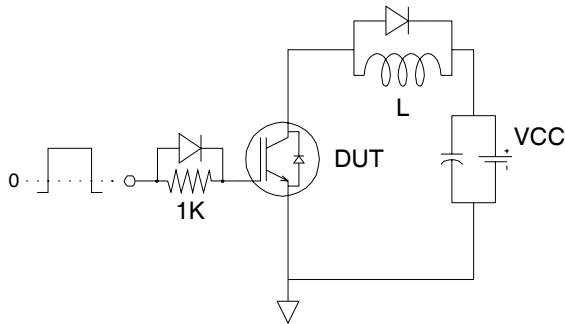

Fig.C.T.1 - Gate Charge Circuit (turn-off)

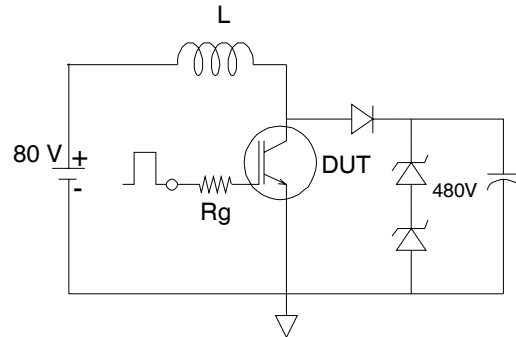

Fig.C.T.2 - RBSOA Circuit

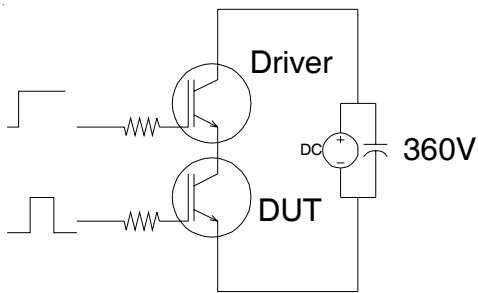

Fig.C.T.3 - S.C.SOA Circuit

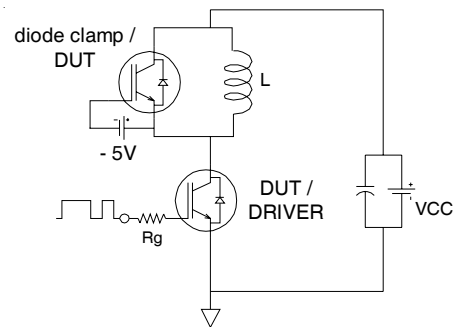

Fig.C.T.4 - Switching Loss Circuit

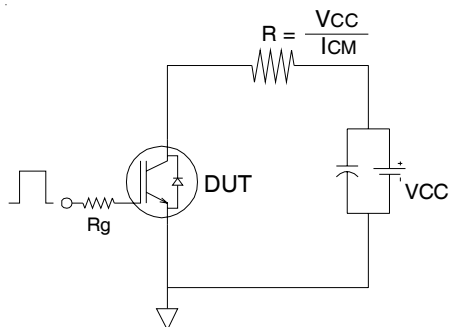

Fig.C.T.5 - Resistive Load Circuit

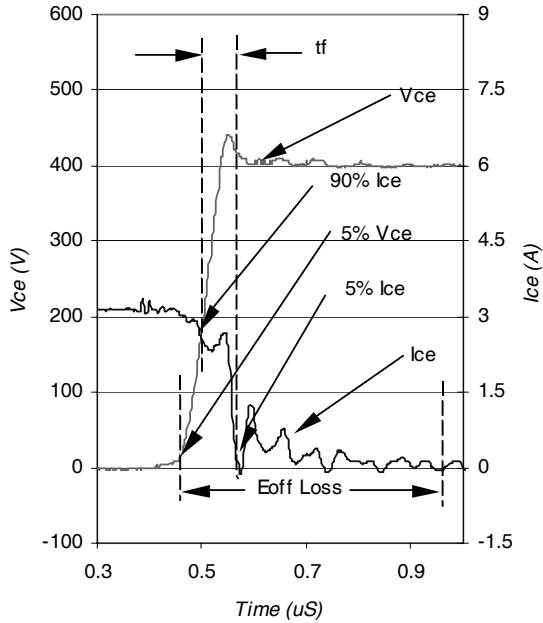

Fig. WF1- Typ. Turn-off Loss Waveform
 @ $T_J = 150^\circ\text{C}$ using Fig. CT.4

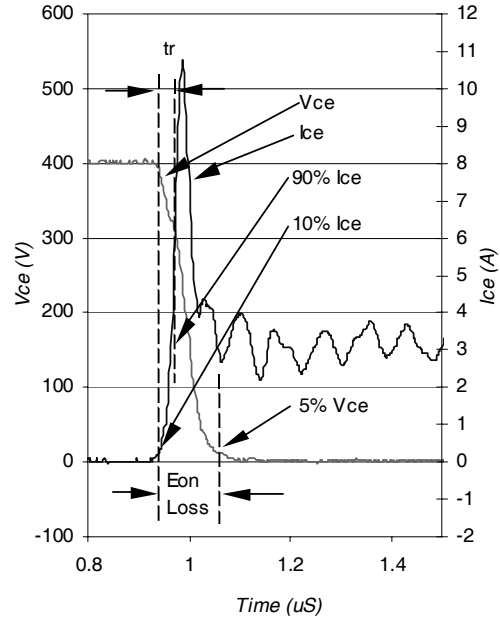

Fig. WF2- Typ. Turn-on Loss Waveform
 @ $T_J = 150^\circ\text{C}$ using Fig. CT.4

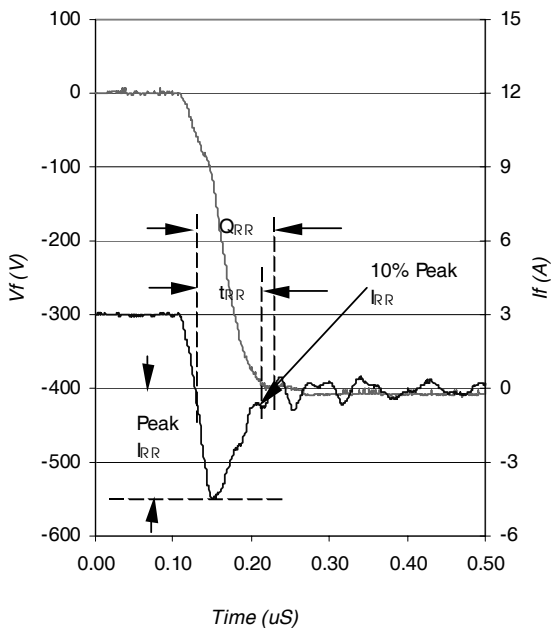

Fig. WF3- Typ. Diode Recovery Waveform
 @ $T_J = 150^\circ\text{C}$ using Fig. CT.4

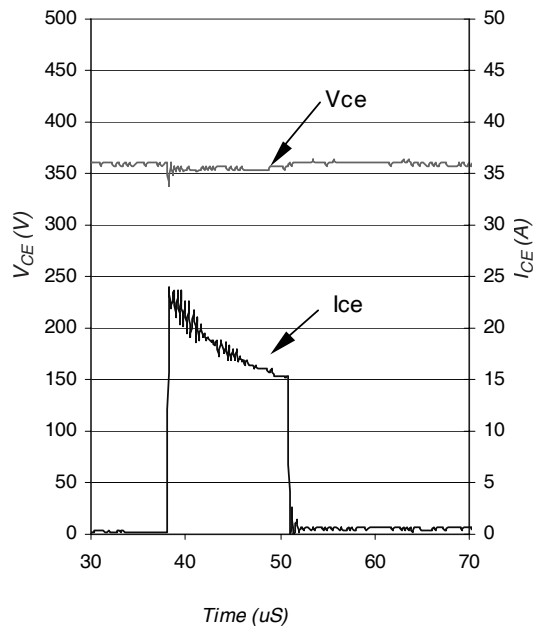

Fig. WF4- Typ. S.C Waveform
 @ $T_C = 150^\circ\text{C}$ using Fig. CT.3

IRGR3B60KD2PbF



D-Pak (TO-252AA) Package Outline

Dimensions are shown in millimeters (inches)

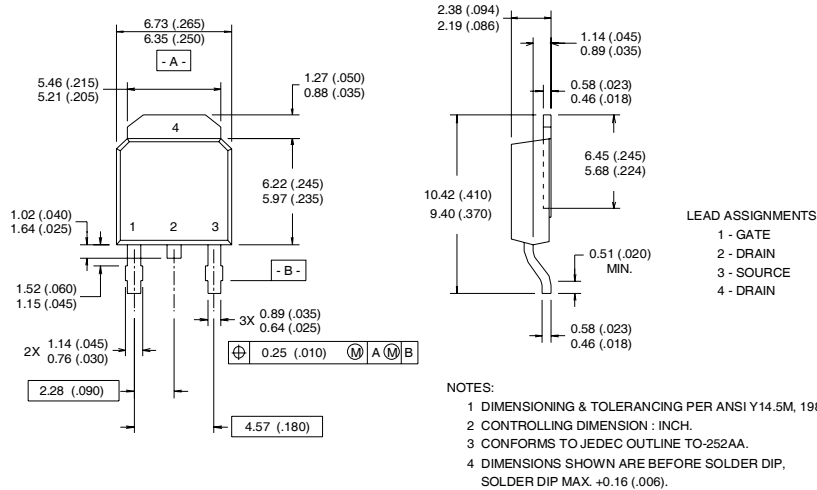

D-Pak (TO-252AA) Part Marking Information (Lead-Free)

EXAMPLE: THIS IS AN IRFR120 WITH ASSEMBLY LOT CODE 1234 ASSEMBLED ON WW 16, 1999 IN THE ASSEMBLY LINE "A"
 Note: "P" in assembly line position indicates "Lead-Free"

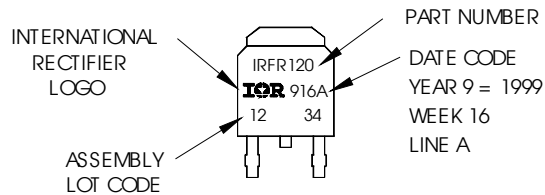

OR

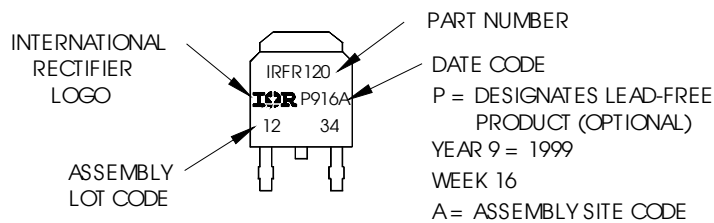

D-Pak (TO-252AA) Tape & Reel Information

Dimensions are shown in millimeters (inches)

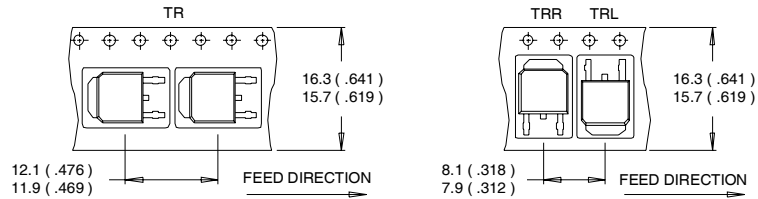

- NOTES :
1. CONTROLLING DIMENSION : MILLIMETER.
 2. ALL DIMENSIONS ARE SHOWN IN MILLIMETERS (INCHES).
 3. OUTLINE CONFORMS TO EIA-481 & EIA-541.

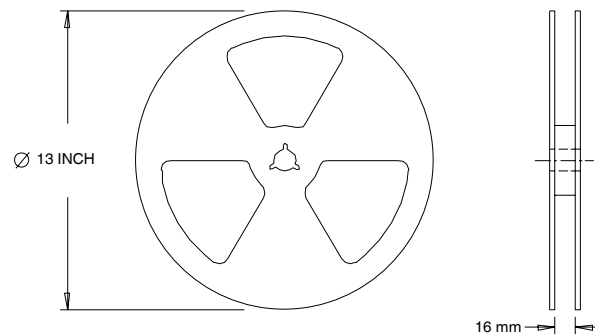

- NOTES :
1. OUTLINE CONFORMS TO EIA-481.

Data and specifications subject to change without notice.
 This product has been designed and qualified for the Industrial market.
 Qualification Standards can be found on IR's Web site.

Note: For the most current drawings please refer to the IR website at:
<http://www.irf.com/package/>