

# SEALED SWITCH MODULE

TC  
SWITCH  
MODULE

SELF-CONTAINED, LONG-LIFE, SEALED SWITCH MODULE WITH UP TO 5 POSITIONS

The TC is a self contained, sealed switch module with up to 5 positions. It can be utilized in numerous applications that require a compact switch module and long life.

At slightly over an inch in diameter, it can be used in a grip, front panel, or hand held device, just to name a few applications. It is available in either a top mount or rear mount.

The advantage of the TC switch module is that it incorporates keypad functionality within a very small footprint. Standard or custom legends are available and can be LED backlit.

Standard termination options include flying leads, ribbon cable (with or without AMP connector) and FFC (flexible flat cable). Tested to three million cycles, the TC switch module has an operating temperature range of -40°C to 85°C and it is sealed to IP68S.

The TC can be used in panel or grip applications and is especially useful in cursor control or data entry applications. Applications include construction, agriculture, industrial, material handling and medical.

## Features:

- **Watertight to IP68S**
- **Great for grips and panels**
- **LED backlight option**
- **3 million cycle electrical life**



TC Standard Characteristics/Ratings:	
<b>ELECTRICAL RATINGS:</b>	1-28VDC @ Sea Level
<b>Load:</b>	10-100mA Resistive
<b>Electrical Life:</b>	3,000,000 cycles
<b>Mechanical Life:</b>	3,000,000 cycles
<b>Seal:</b>	IP68S
<b>Operating Temp Range:</b>	-40°C to +85°C
<b>Operating Force:</b>	1.0 +/- .5 lbs.
<b>Pushout Force:</b>	5 lbs. min.
<b>MATERIALS:</b>	
<b>Housing:</b>	PBT
<b>Keypad:</b>	Silicone Rubber
<b>Terminal Hardware:</b>	None provided
<b>Mounting Hardware:</b>	VHB tape

## TC Switch Module Keypad Configurations

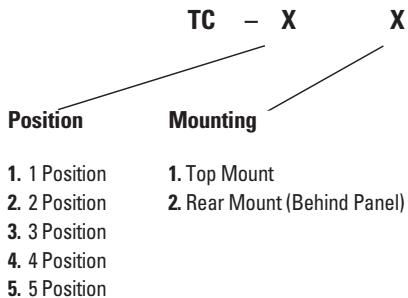
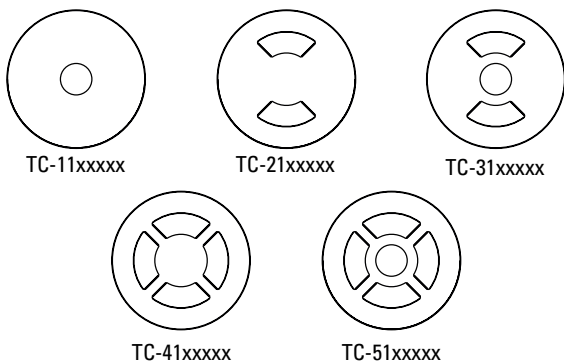

## TC PART NUMBER CODE

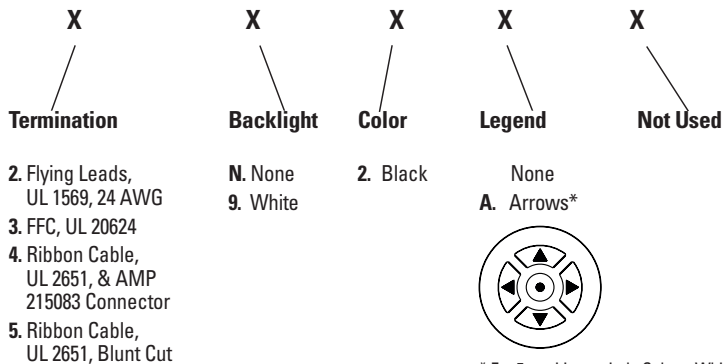

\* For 5-position switch, Color = White

SELF-CONTAINED, LONG-LIFE, SEALED SWITCH MODULE WITH UP TO 5 POSITIONS

**TC-51xxxxx**  
**Top Mount, 5 Position Module**

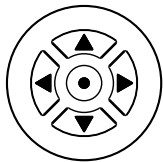
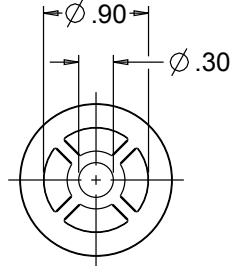

Standard legend configuration

**Rear Mount**

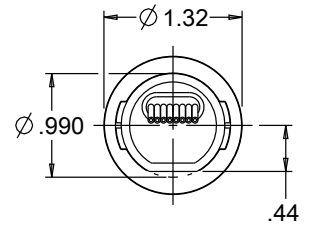
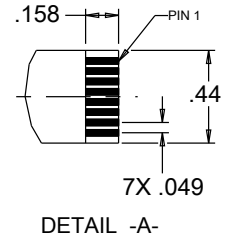
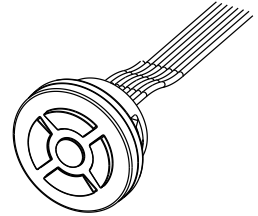
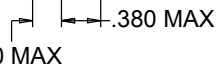
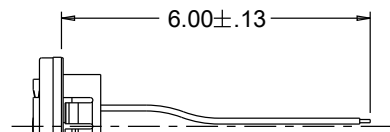
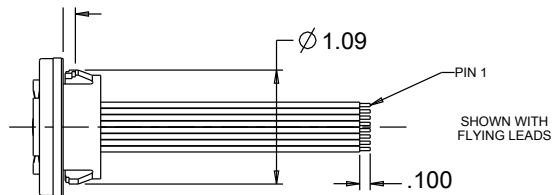
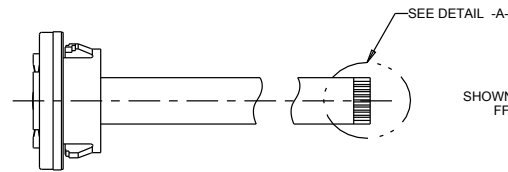
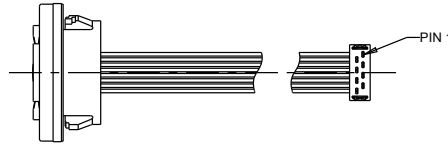
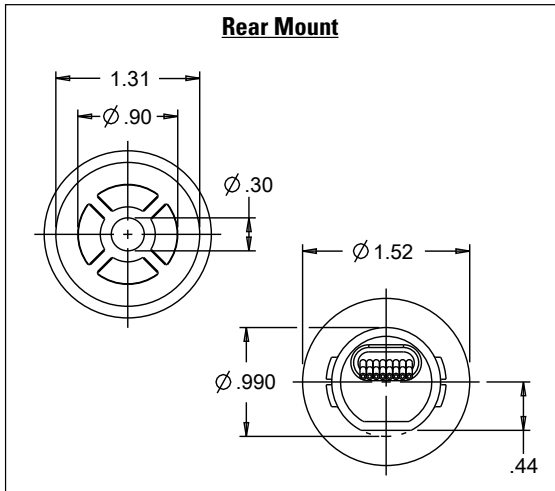

**TC Switch Module Keypad Configurations**

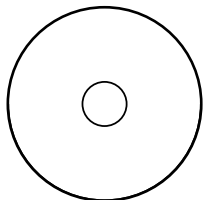

TC-11xxxxx

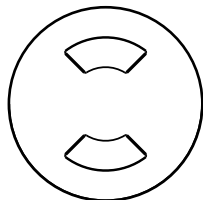

TC-21xxxxx

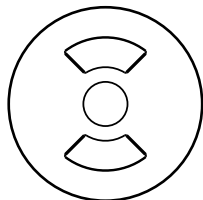

TC-31xxxxx

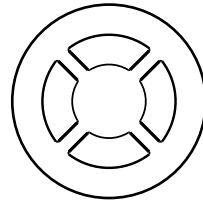

TC-41xxxxx

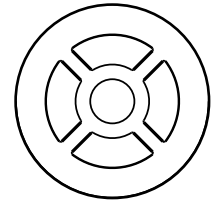

TC-51xxxxx