

**10 Pole
With Ground**
PROTECTION
IP65
RATING
E307105
CE

**Component
Parts**

Pre-Assembled Units

Covers

**FEMALE
Insert**

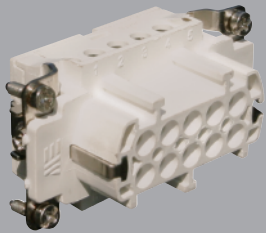

29020

Bulkhead Housing

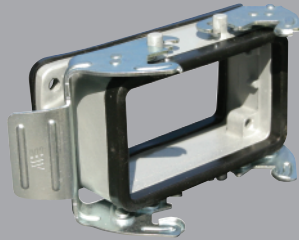

29040

Hood

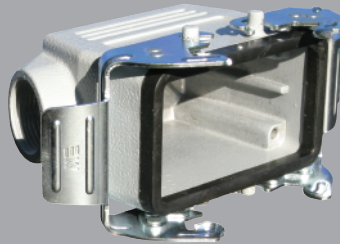

29049
29049M

**Surface Mount
Housing**

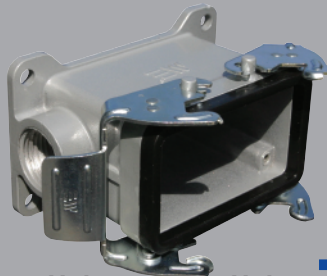

1 Hole 29054
29054M
2 Hole 29055
29055M

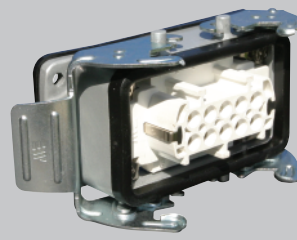

403020

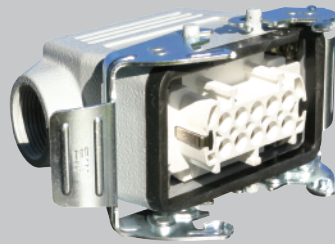

403025
403025M

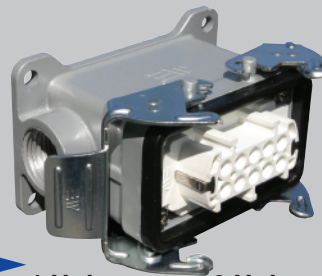

1 Hole 403026
403026M
2 Hole 403028
403028M



29650

Standard Part Numbers are
NPT threads.
Part numbers with an "M"
are metric thread.

**MALE
Insert**

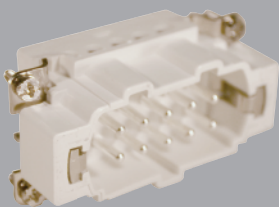

29021

Hood

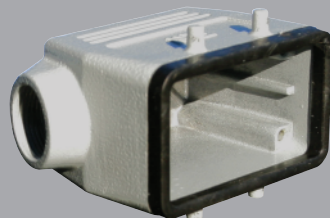

29041
29041M

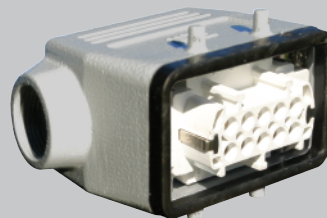

403023
403023M

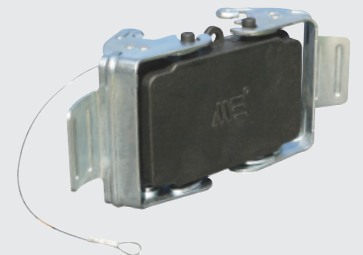

29653

Connectors should not be coupled
and decoupled under electrical load.

Inserts

Number of contacts	10 Pole w/ ground
Electrical data to DIN EN61 984	16A 400V 6KV 3
Current	16A
Voltage	400V
Rated Impulse Voltage	6KV
Insulation Resistance	≥10 ¹⁰ Ω
Temperature Range	-40 to 125°C
Flammability	UL94-V0

Contacts

Screw terminal	
Material	Copper alloy
Surface plated	hard-silver
Contact resistance	≤ 1m Ω
Wire size	2.5mm ² / 14 AWG
Torque	0.5Nm
Stripping Length	7.5mm

Metal Hoods & Housings

Material	Aluminum
Surface	Powder coated
Seals	NBR
Degree of Protection Acc To	IP65
DIN EN60529 for coupled connectors	IP65
Thread Size	NPT 1/2" or M25

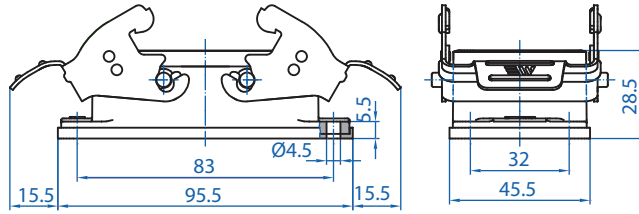

29040

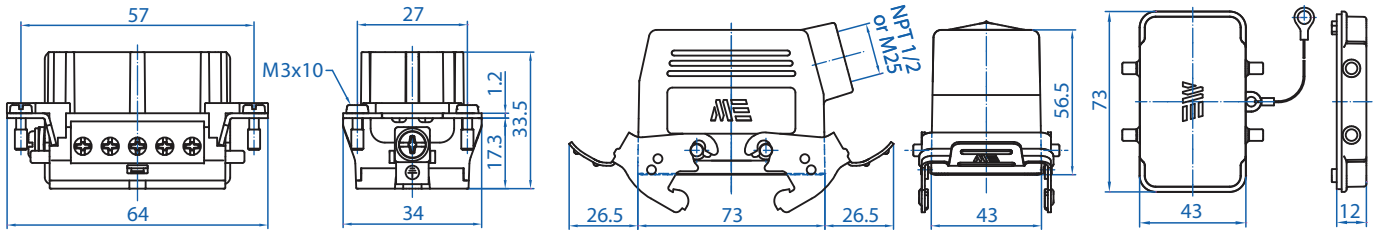

29020

29049

29650

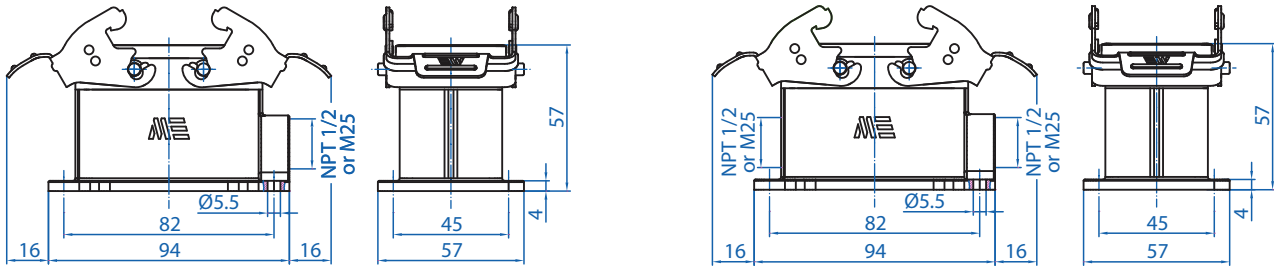

29054

29055

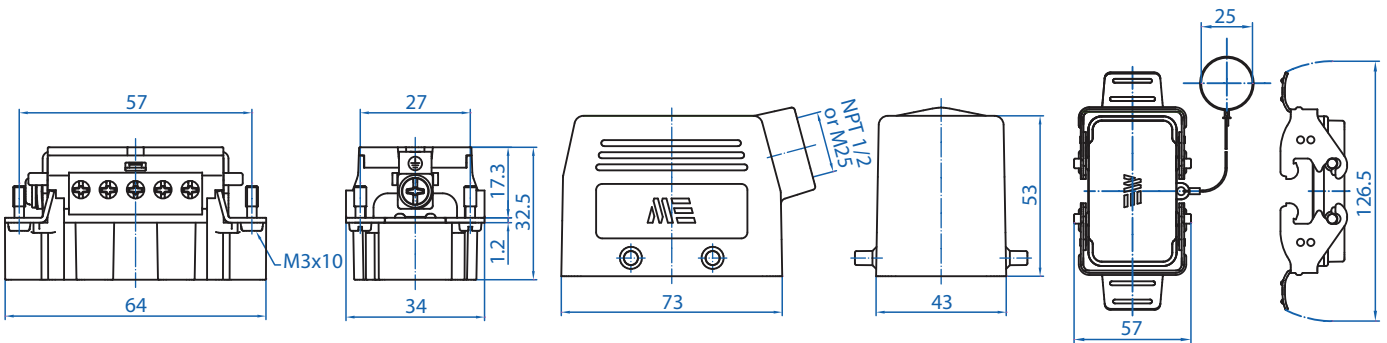

29021

29041

29653



Connectors should not be coupled and decoupled under electrical load.

All dimensions are shown in millimeters. To convert to inches divide by 25.4.