

WS Aware Monitor Installation, Operation and Maintenance



Figure 1. SCS 770061 WS Aware Monitor with Standard Remotes



Figure 2. SCS 770062 WS Aware Monitor with Big Brother Remotes

Description

The SCS WS Aware Monitor is a dual workstation continuous monitor for operators, ESD worksurfaces and metal tools. It continuously monitors the path-to-ground integrity and body voltage of two operators, as well as the path-to-ground integrity for two conductive or dissipative worksurfaces and two metal tools. It also continuously monitors for electromagnetic interference (EMI) on two metal tools which may cause electrical overstress (EOS) damage. The WS Aware Monitor eliminates the need for periodic testing and record keeping of wrist straps.

The WS Aware Monitor is designed with digital signal processing technology for true continuous monitoring (versus pulsed or intermittent) of wrist strap functionality (path-to-ground and presence of 1 megohm resistor) and operator safety according to accepted industry standards without capacitance variations from personnel or environment. Digital signal processing technology uses dual-wire wrist straps to apply an ultra-low test voltage of 0.05V onto the operator for the handling of sensitive components.

The WS Aware Monitor features operator body voltage detection. It will alarm if the operator generates or comes in contact with voltage that would be dangerous to an ESD susceptible item.

The WS Aware Monitor continuously monitors two metal tools for electromagnetic interference (EMI). EMI can cause equipment lockups and malfunction. The WS Aware Monitor will alarm if EMI is detected. Each WS Aware Monitor is calibrated with accepted procedures and standards traceable to the National Institute of Standards and Technology (NIST) and includes a certificate of calibration.

ANSI/ESD S20.20 section 7.3 states “Compliance verification records shall be established and maintained to provide evidence of conformity to the technical requirements.” Per ANSI/ESD S1.1 Annex A.3 Daily (wrist strap system) testing may be omitted if constant monitoring used.” Per ESD Handbook ESD TR 20.20 section 5.3.2.4.4 “Typical Test programs recommend that wrist straps that are used daily should be tested daily. However, if the products that are being produced are of such value that knowledge of a continuous, reliable ground is needed, and then continuous monitoring should be considered or even required.”

The WS Aware Monitor and its accessories are available as the following item numbers:

Item	Description
770061	WS Aware Monitor, with Standard Remotes
770062	WS Aware Monitor, with Big Brother Remotes
770064	Power Adapter, 100-240VAC Input, 7.5 VDC 1.5A Output, All Plugs
CTE701	Workstation Monitor Checker
CTA242	Operator Remote, Standard
CTA243	Operator Remote, Big Brother
CTA245	Replacement Wrist Strap Jack PCB
770055	SMP Software



Static Management Program

The SCS 770061 and 770062 WS Aware Monitors are compatible with SCS Static Management Program (SMP). SMP continuously monitors your ESD process control system throughout all stages of manufacturing. SMP captures data from SCS workstation, equipment and ESD event continuous monitors and provides a real-time picture of critical manufacturing processes. All activity is stored into a database for on-going quality control purposes. SMP allows you to pinpoint areas of concern and prevent ESD events. Quantifiable data allows you to see trends, become more proactive and prove the efficiency of your ESD process control system.

SMP is sold separately. [Click here](#) to learn more.

Packaging

- 1 WS Aware Monitor
- 2 Operator Remotes
- 2 Mini-DIN Operator Remote Cables
- 2 Mat Monitor Cords (White)
- 1 Monitor Ground Cord (Green and Yellow)
- 2 Push and Clinch Snaps
- 2 Ring Magnets
- 1 Ring Terminal
- 2 Screw, Flat Head, 4-40 x 1/4"
- 1 Screw, Pan-Head, 6-32 x 1/4"
- 1 Star Washer
- 2 Nylon Spacers
- 1 Power Adapter, 7.5 VDC, with interchangeable plugs (North America, UK/Asia, Europe, China)
- 1 Certificate of Calibration

Features and Components

WS AWARE MONITOR

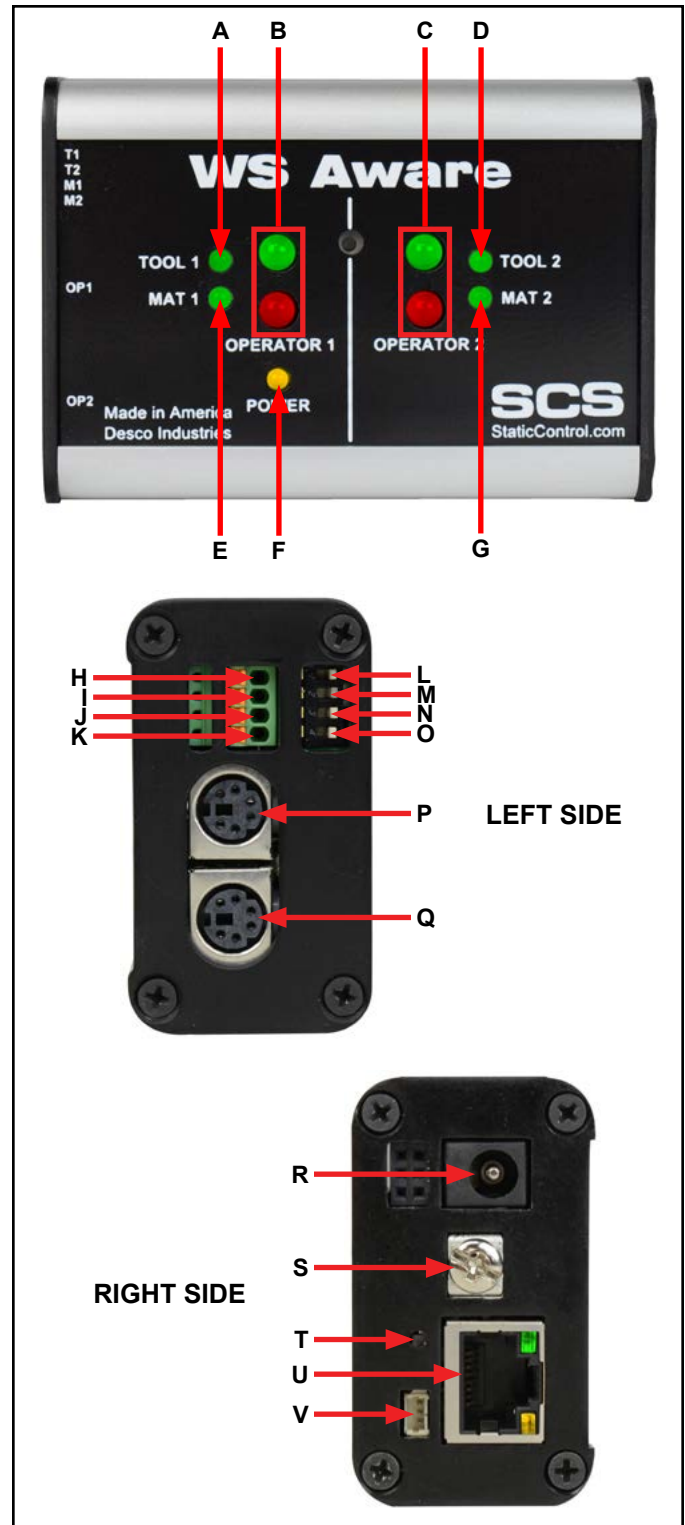

Figure 3. WS Aware Monitor features and components

A. Tool 1 LED: Illuminates green when tool 1 is properly grounded and free of electromagnetic interference (EMI). Illuminates red and audible alarm sounds when tool 1 is not properly grounded or EMI is detected.

B. Operator 1 LEDs: Illuminates green when operator 1 is properly grounded and his/her body voltage level is below the preset alarm level. Illuminates solid red and audible alarm sounds when operator 1 is not properly grounded. Blinks red and audible alarm sounds when the body voltage on operator 1 is above the preset alarm level.

C. Operator 2 LEDs: Illuminates green when operator 2 is properly grounded and his/her body voltage level is below the preset alarm level. Illuminates solid red and audible alarm sounds when operator 2 is not properly grounded. Blinks red and audible alarm sounds when the body voltage on operator 2 is above the preset alarm level.

D. Tool 2 LED: Illuminates green when tool 2 is properly grounded and free of electromagnetic interference (EMI). Illuminates red and audible alarm sounds when tool 2 is not properly grounded or EMI is detected.

E. Mat 1 LED: Illuminates green when mat 1 is properly grounded. Illuminates red and audible alarm sounds when mat 1 is not properly grounded.

F. Power LED: Illuminates solid yellow when the monitor is powered and not connected to a network. Blinks yellow when the monitor is powered, connected to a network and in communication with SMP Server. Remains off when the monitor is connected to a network but communication to SMP Server cannot be obtained.

G. Mat 2 LED: Illuminates green when mat 2 is properly grounded. Illuminates red and audible alarm sounds when mat 2 is not properly grounded.

H. Monitored Tool 1 Terminal: Monitors a metal tool for proper conductive resistance and electromagnetic interference (EMI). Use 25-28 AWG wire to connect the metal tool to this terminal.

I. Monitored Tool 2 Terminal: Monitors a metal tool for proper conductive resistance and electromagnetic interference (EMI). Use 25-28 AWG wire to connect the metal tool to this terminal.

J. Monitored Mat 1 Terminal: Monitors a worksurface mat for proper dissipative resistance. Use one of the included white mat monitor cords to connect the worksurface mat to this terminal.

K. Monitored Mat 2 Terminal: Monitors a worksurface mat for proper dissipative resistance. Use one of the included white mat monitor cords to connect the worksurface mat to this terminal.

L. Tool 1 Monitor Switch: Toggle the switch down to enable the Tool 1 monitor circuit. Toggle the switch up to disable the Tool 1 monitor circuit.

M. Tool 2 Monitor Switch: Toggle the switch down to enable the Tool 2 monitor circuit. Toggle the switch up to disable the Tool 2 monitor circuit.

N. Mat 1 Monitor Switch: Toggle the switch down to enable the Mat 1 monitor circuit. Toggle the switch up to disable the Mat 1 monitor circuit.

O. Mat 2 Monitor Switch: Toggle the switch down to enable the Mat 2 monitor circuit. Toggle the switch up to disable the Mat 2 monitor circuit.

P. Operator 1 Remote Connector: Use one of the included mini-DIN operator remote cables to connect a operator remote to this connector.

Q. Operator 2 Remote Connector: Use one of the included mini-DIN operator remote cables to connect a operator remote to this connector.

R. Power Jack: Connect the included 7.5 VDC power adapter here.

S. Ground Terminal: Common ground point for the monitor.

T. Audible Alarm Switch: Enables and disables the monitor's audible alarm. 5 different audible alarm settings are available and may be toggled by pressing this switch multiple times. The monitor can be configured to alarm should either of its Operator Remotes disconnect. See the table below for descriptions of each setting.

Setting	Buzzer	Operator 1 Remote Detection	Operator 2 Remote Detection
1	Enabled	Enabled	Enabled
2	Disabled	Disabled	Disabled
3	Enabled	Disabled	Disabled
4	Enabled	Enabled	Disabled
5	Enabled	Disabled	Enabled

U. Ethernet Jack: Provides network communication between the WS Aware Monitor and [Static Management Program \(SMP\)](#).

V. Relay Terminal: Integrates with electronic tools, lights, buzzers, etc. Use the Molex #15134-0302 PicoBlade™ Cable Assembly to pair with this terminal's male connector.

OPERATOR REMOTES

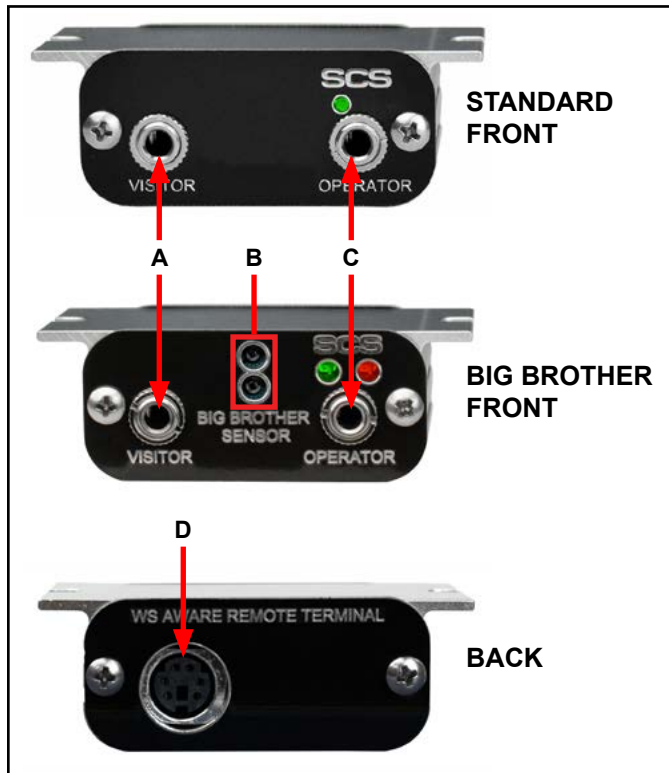

Figure 4. Operator Remote features and components

A. Visitor Jack: Insert the dual-wire wrist cord of a visitor here to connect him/her to ground. This connection is not monitored, and it can only be used when the operator jack is occupied. The WS Aware Monitor will alarm if the visitor jack is used without an occupied operator jack.

B. Big Brother Sensors: Detects the presence of an operator up to 12 inches away and alarms if a wrist strap is not connected within 4 seconds to prevent ungrounded handling of ESD susceptible items.

C. Monitored Operator Jack: Insert the dual-wire wrist cord of an operator here to monitor his/her body voltage and connection to ground.

D. WS Aware Monitor Connector: Use one of the included mini-DIN operator remote cables to connect the WS Aware Monitor to this connector.

Installation

Hardware Setup

1. Remove the WS Aware Monitor and its operator remotes from the carton, and inspect for damage.
2. Determine the mounting location of the WS Aware Monitor. Its display should be visible to the operators. Use the two 4-40 threaded holes at the back of its enclosure and the included ring magnets and 4-40 threaded screws if desired.

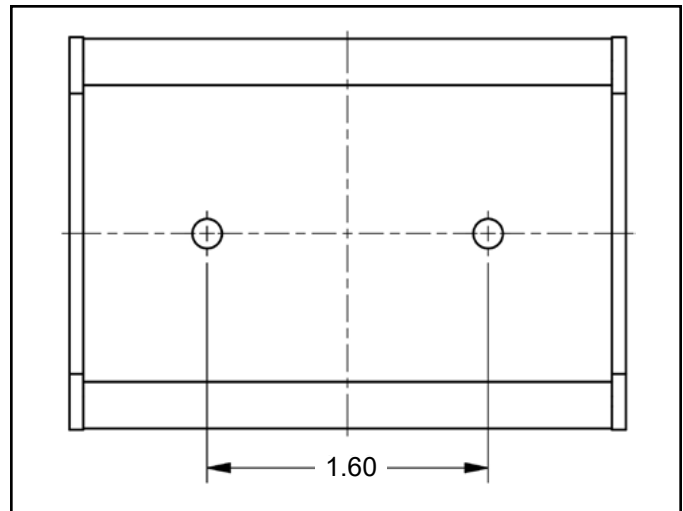

Figure 5. Mounting hole locations on the back of the WS Aware Monitor (all dimensions are in inches)

3. Determine the mounting locations of the two operator remotes. Their jacks should be accessible to the operators. Locate them within reach of the included mini-DIN operator remote cables. Use the operator remotes' mounting tabs to secure them underneath table tops or equipment.
4. Connect the included mini-DIN operator remote cables to the operator remote connectors located on the left-side of the WS Aware Monitor.
5. Route the mini-DIN operator remote cables from the left-side of the WS Aware Monitor to their respective operator remotes. Connect the cables to the back of the operator remotes.
6. Insert the tinned terminations of the mat monitor cords into the mat 1 and mat 2 terminals located on the left-side of the WS Aware Monitor. Use a small screwdriver or probe to push down the orange spring contacts and open their respective terminal gates. Insert the tinned wire, and let go of the spring contact to latch onto the wire. Ensure that the mat monitor switches are enabled if using these monitored mat circuits.
7. Route the mat monitor cords from the left-side of the WS Aware Monitor to their respective worksurface mats. Use the included push and clinch snaps to secure the cords to the grounded mats.
8. Insert stripped terminations of tool monitor wires (not included) into the tool 1 and tool 2 terminals located on the left-side of the WS Aware Monitor. 25-28 AWG wire may be used. Use a small screwdriver or probe to push down the orange spring contacts and open their respective terminal gates. Insert the tinned wire, and let go of the spring contact to latch onto the wire. Ensure that the tool monitor switches are enabled if using these monitored tool circuits.

9. Route the tool monitor wires from the left-side of the WS Aware Monitor to their respective grounded metal tools, and secure them.
10. Secure one end of the included ground cord to the ground terminal located on the right-side of the WS Aware Monitor. Attach the other end of the cord to a ground point. The face plate screw of a grounded AC wall outlet may provide a convenient connection point.
11. Connect an Ethernet cable to the Ethernet jack located on the right-side of the WS Aware Monitor. Verify that the cable is properly connected to a network.
12. Connect the power adapter to the power jack located on the right-side of the WS Aware Monitor. Route the wire from the supply to a nearby AC outlet and plug it into the outlet. Make sure the voltage and frequency match those listed on the power supply. The WS Aware Monitor is now powered.

NOTE: Worksurface must have a conductive layer such as Dual Layer Rubber or Dissipative 3-Layer Vinyl with conductive buried layers. SCS workstation monitors are not recommended for use with homogeneous matting.

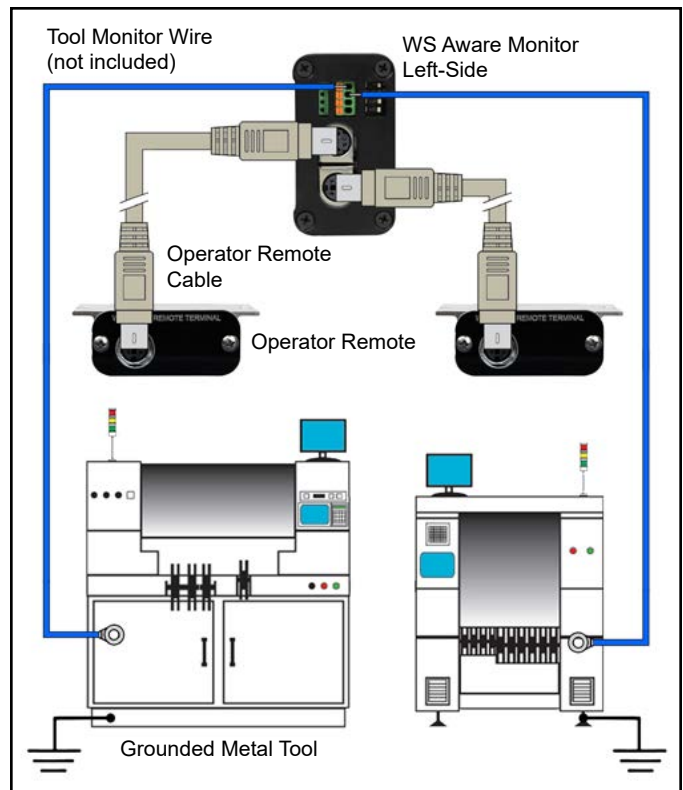

Figure 7. Wiring the WS Aware Monitor to two metal tools

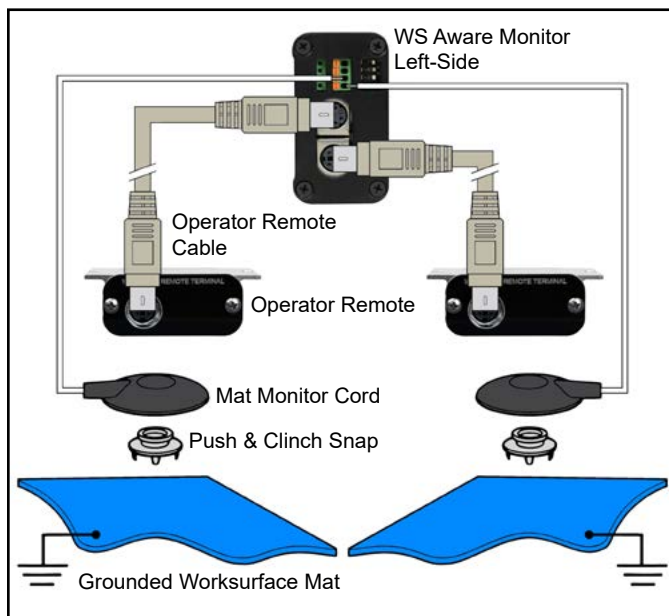

Figure 6. Wiring the WS Aware Monitor to two workstations

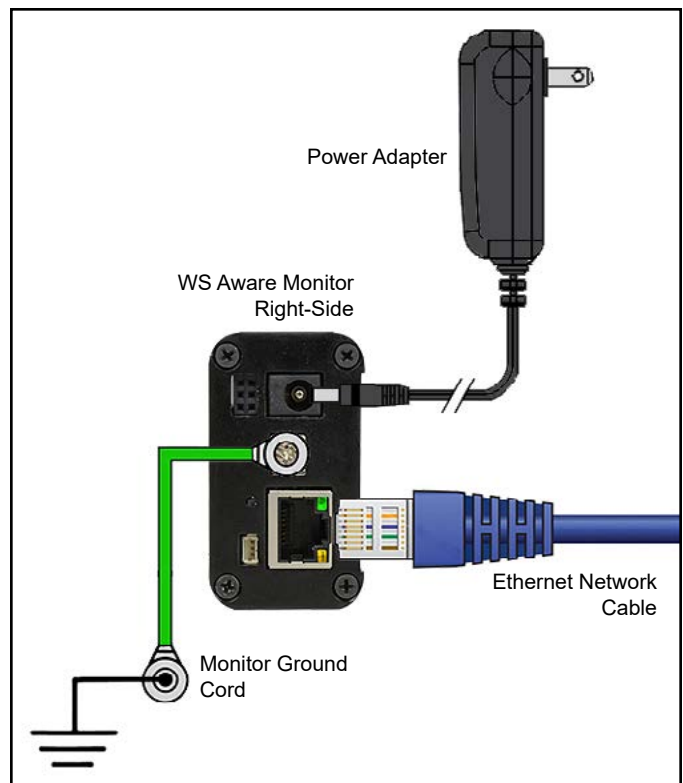

Figure 8. Connecting the WS Aware Monitor to ground, Ethernet and power.

Relay Terminal

The WS Aware Monitor features one optical relay terminal that can be integrated with electronic tools, lights, buzzers, etc. The relay opens when the monitor enters any alarm condition, and it remains closed otherwise. Use the Molex #15134-0302 PicoBlade™ Cable Assembly to pair this connector with the desired electronic item.



Figure 9. Relay terminal pin-out

Relay Parameter	Rating
Peak Blocking Voltage	30 V _P
Load Current	140 mA _{rms} / mA _{DC}
On-Resistance (max)	22 ohms

SMP Network Setup

The following procedure outlines how to connect the WS Aware Monitor to SMP via a local area network (LAN). SMP must be installed to a PC prior to using this procedure. The diagram shown below illustrates a common SMP system setup that utilizes the server software, client software, WS Aware Monitor, EM Aware Monitor, and Ground Master Monitor.

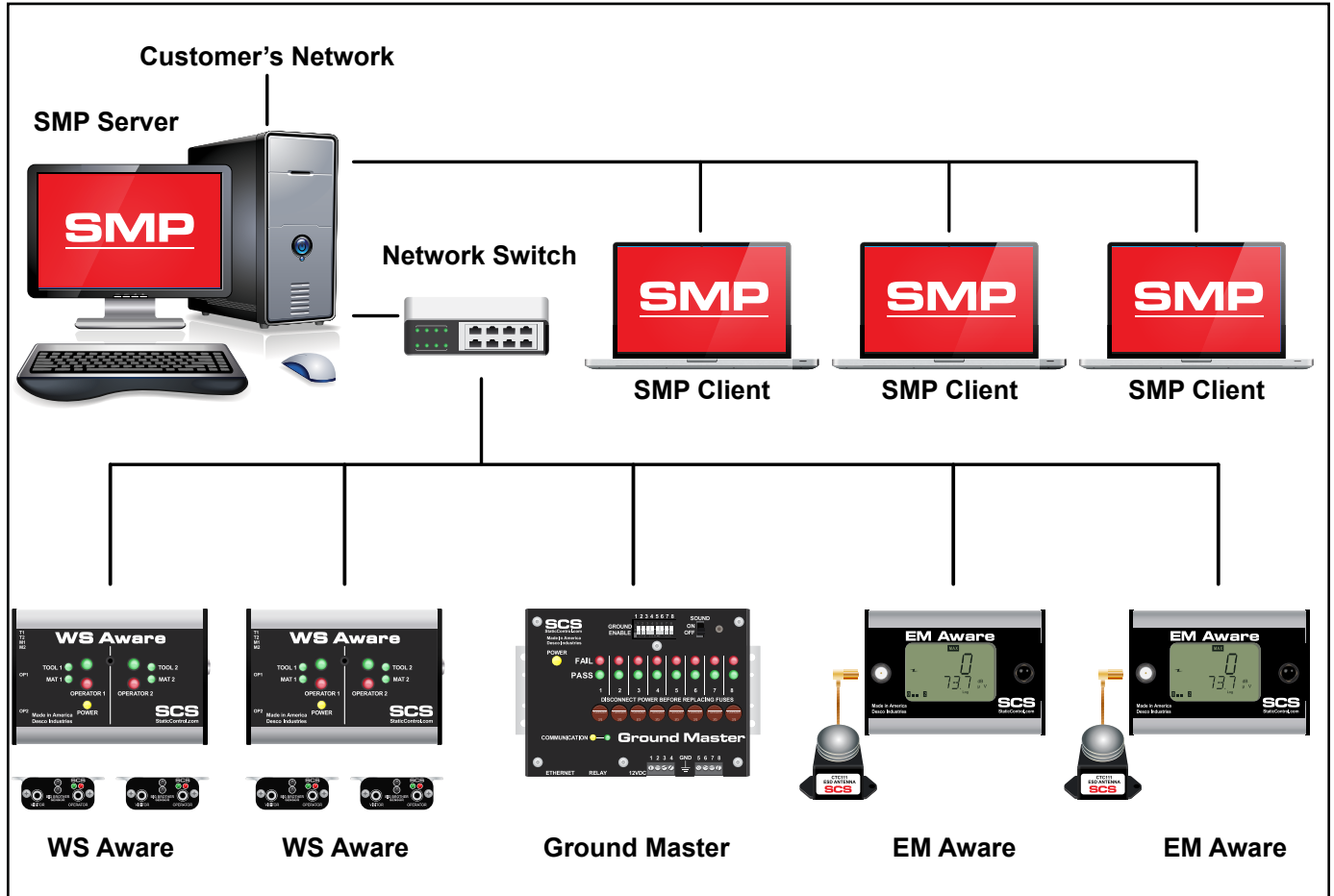
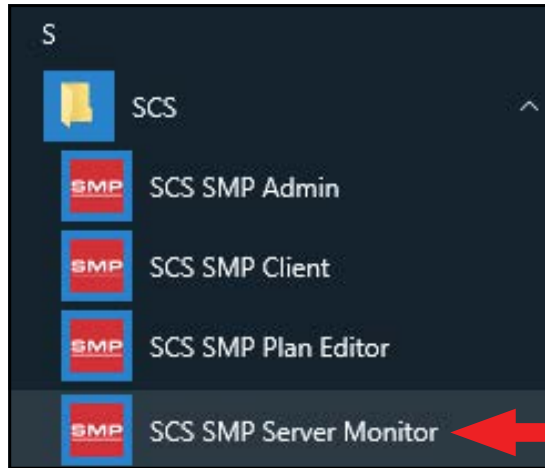

Figure 10. SMP system setup

DYNAMIC IP PROCEDURE

1. Verify that the Ethernet cable is securely connected to your network and WS Aware Monitor. The LEDs on the Ethernet port will illuminate when a connection to the network is established.
2. Open SCS SMP Server Monitor.



3. The SMP Server icon will appear in the Windows taskbar.

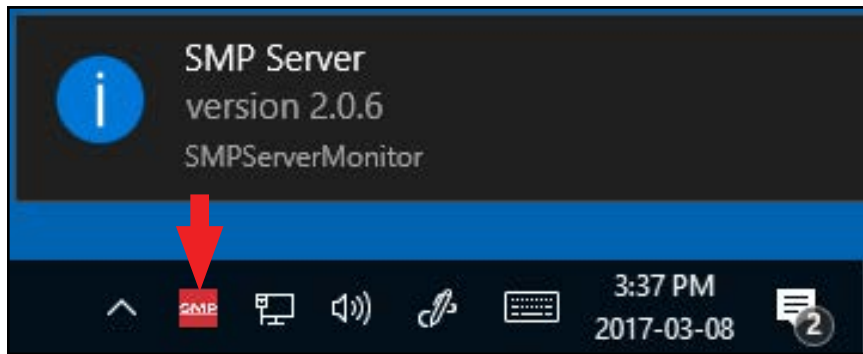

4. Click the SMP Server icon located on the Windows taskbar. The SMP Server menu will appear. Click the Start button to start SMP Server.



5. A message will appear and display “Starting SMP Server...” Click the SMP Server icon located in the Windows taskbar.

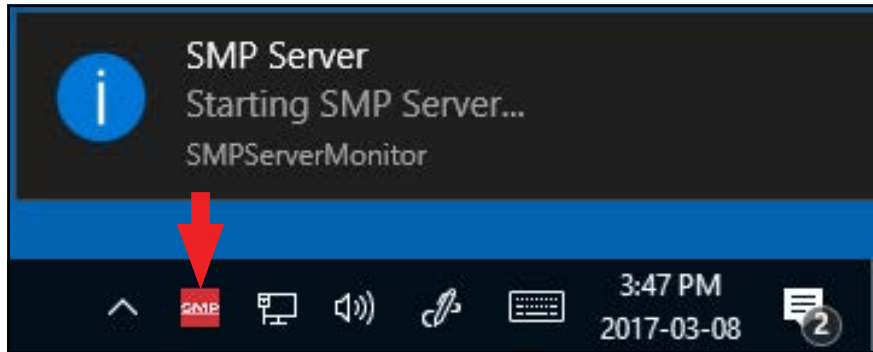

6. SMP Server will now indicate Active server status.

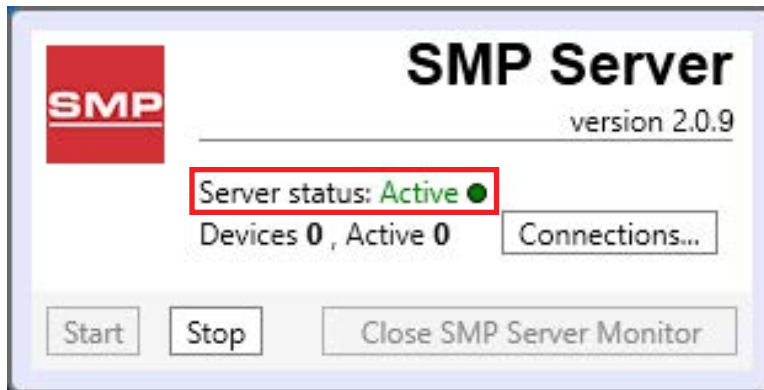

7. SMP Server will search and find the WS Aware Monitor on the network. The Device and Active counts will increase to 1.

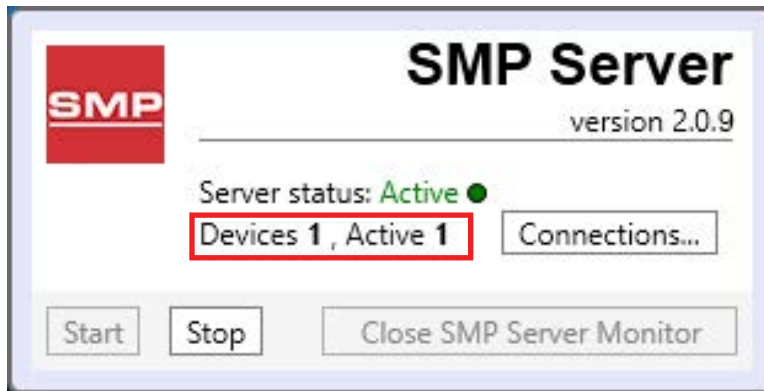

8. Open SCS SMP Admin.

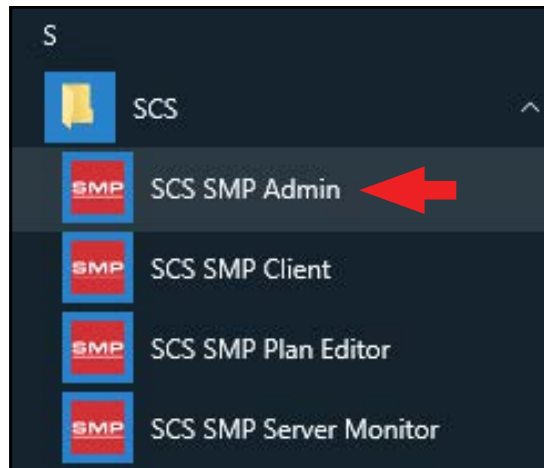

9. The window for SMP Server Admin will appear. "1 unassigned" is representative of the WS Aware Monitor that was just found by SMP Server. Click the Add New Building button.

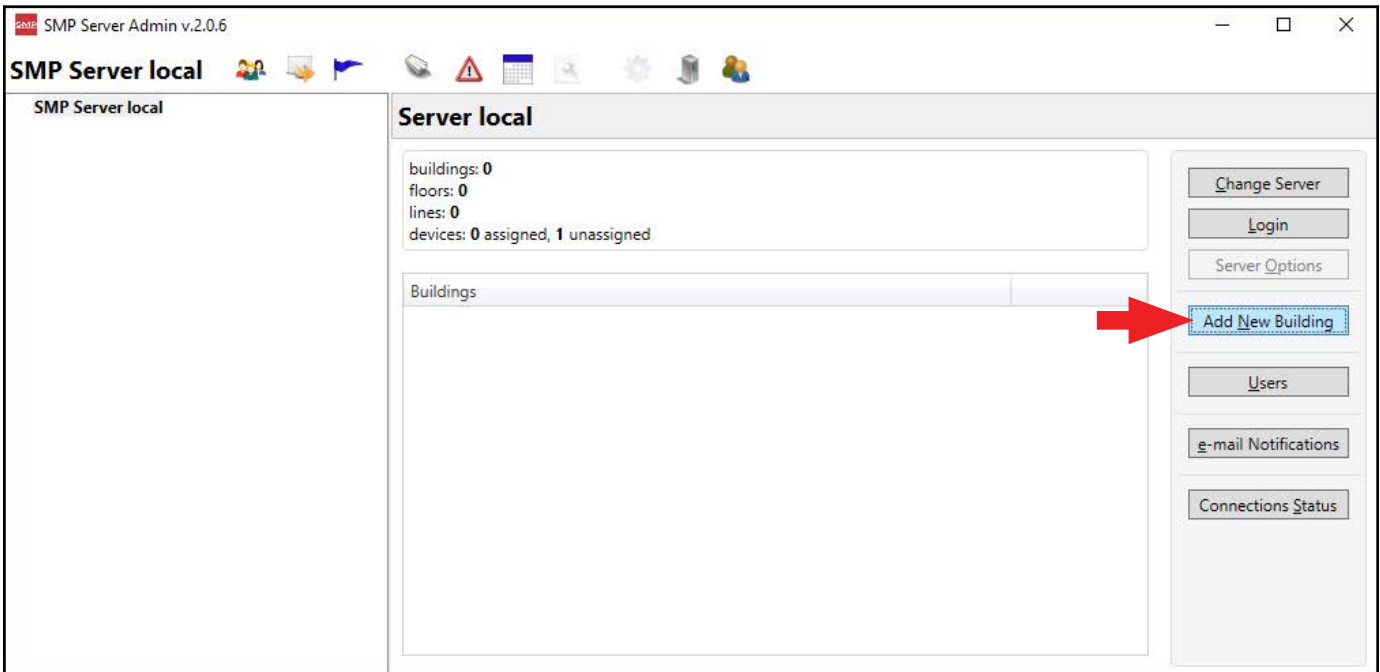

10. Enter a building name, and then click the OK button.

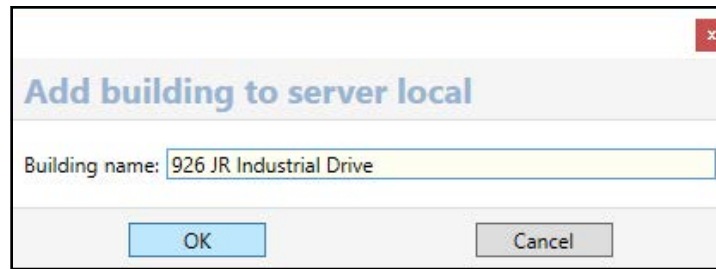

11. The building name will appear on the navigation pane in SMP Server Admin.

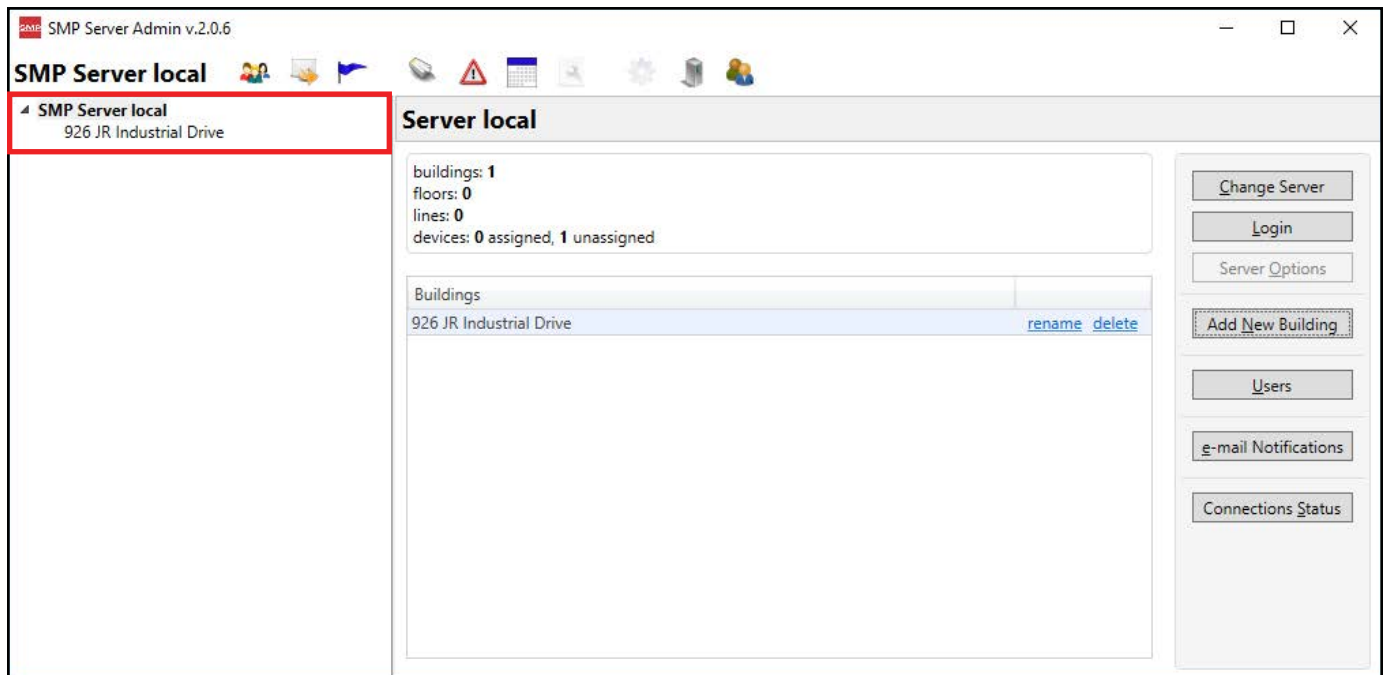

12. Click on the building name in the navigation pane, and then click the Add New Floor button.

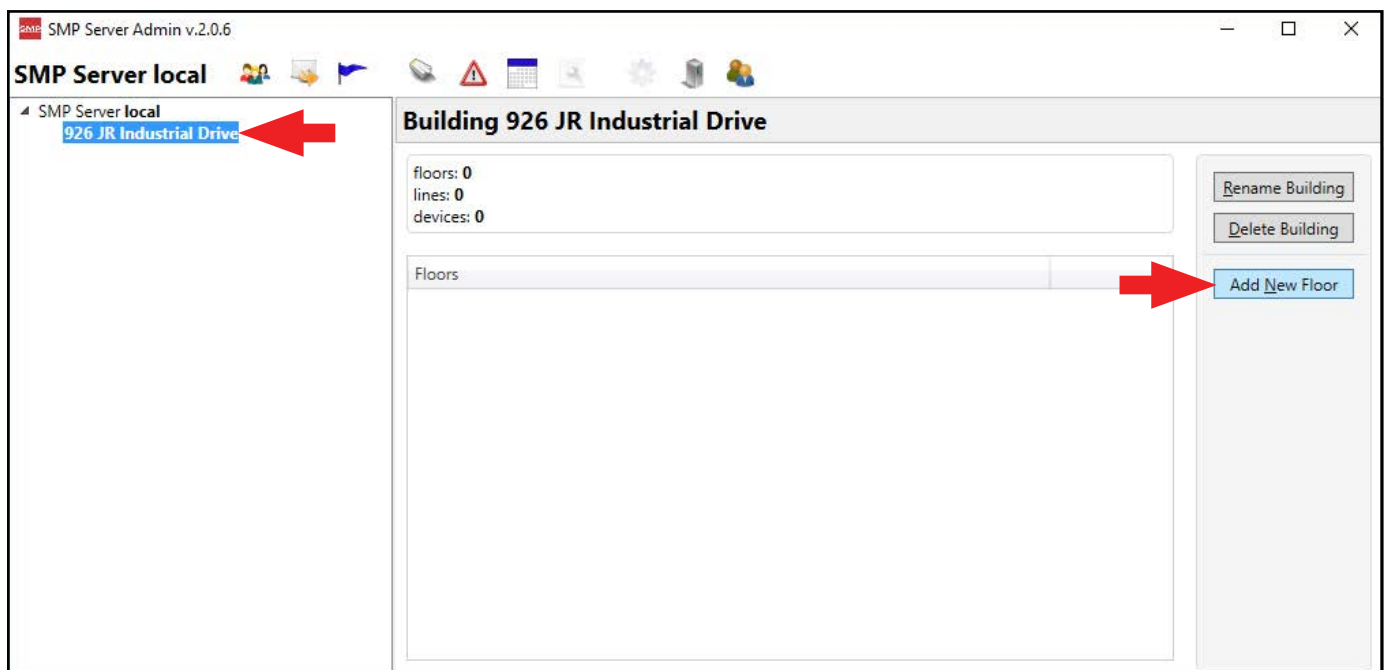

SCS - 926 JR Industrial Drive, Sanford, NC 27332
East: (919) 718-0000 | West: (909) 627-9634 • Website: StaticControl.com

13. Enter a floor name, and then click the OK button.

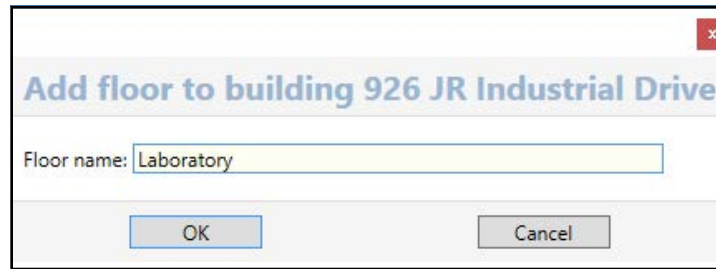

14. The floor name will appear on the navigation pane in SMP Server Admin.

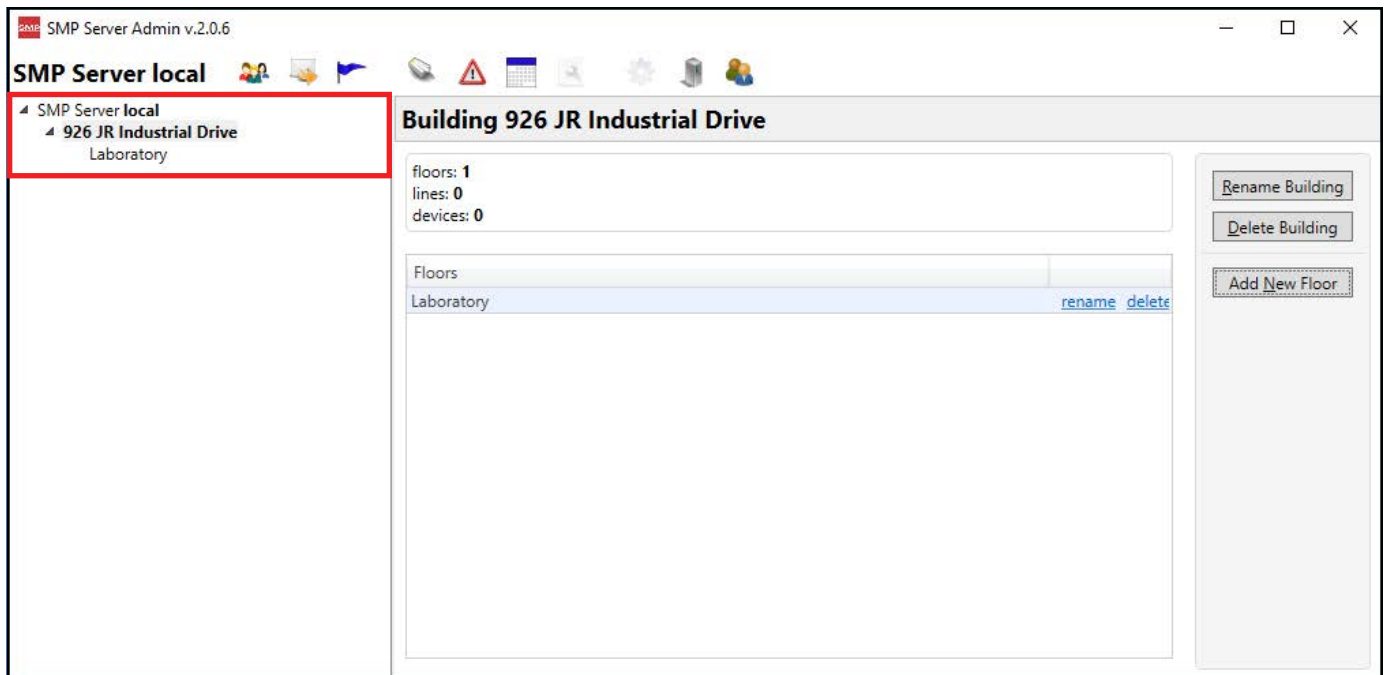

15. Click on the floor name in the navigation pane, and then click the Add New Line button.

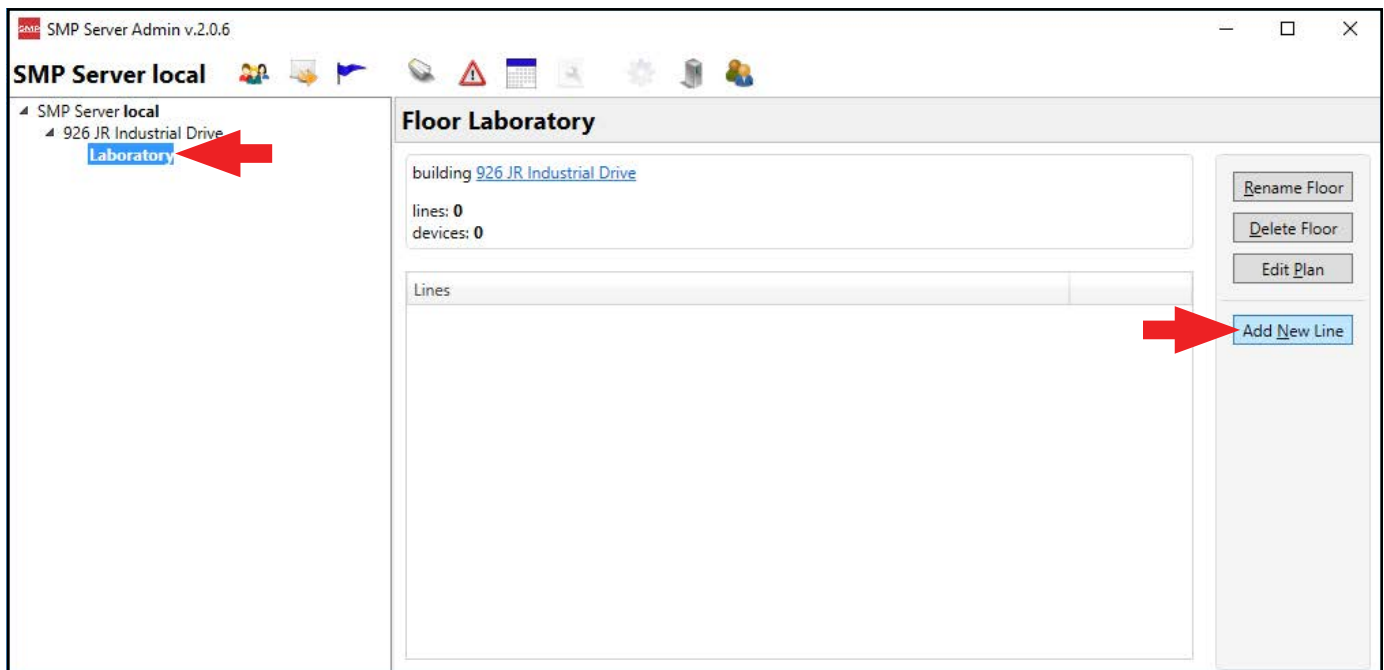

16. Enter a line name, and then click the OK button.

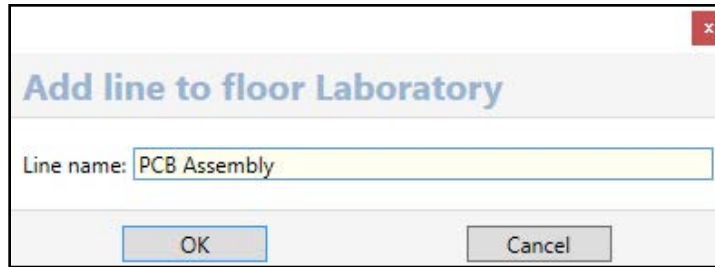

17. The line name will appear on the navigation pane in SMP Server Admin.

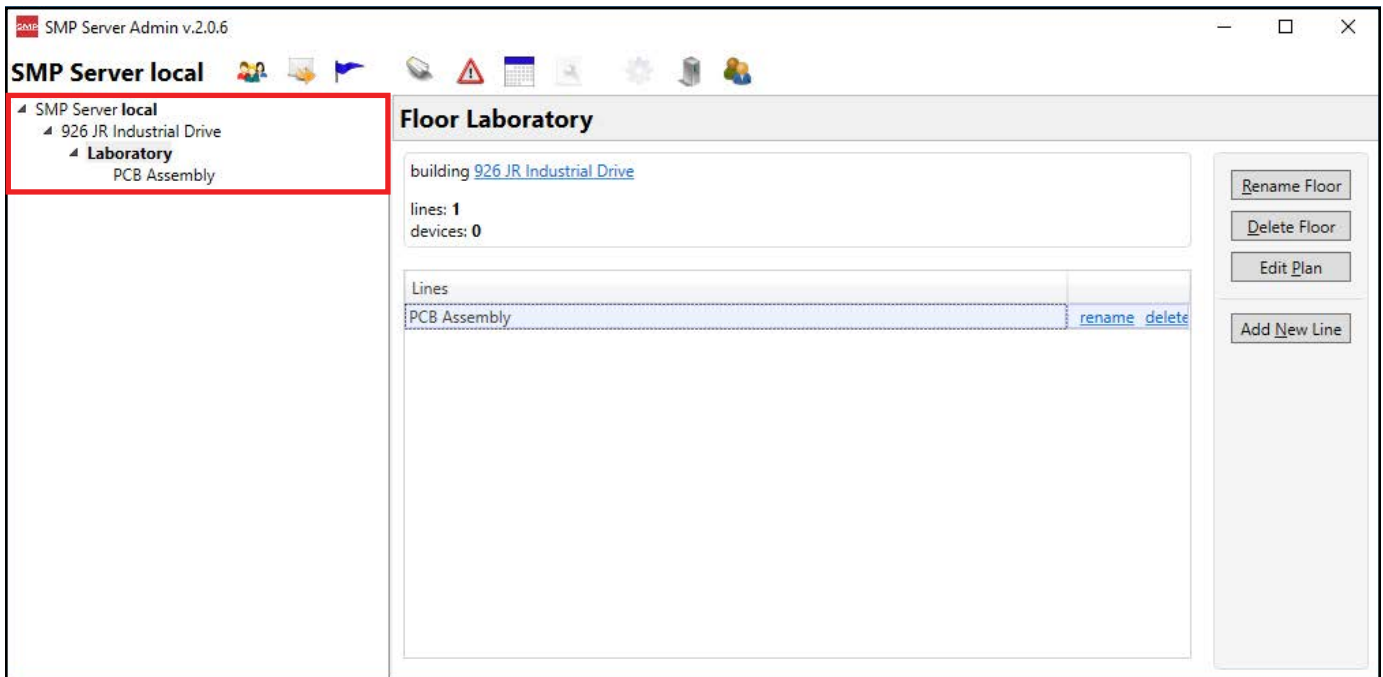

18. Click on the line name in the navigation pane, and then click the Attachable Devices arrow located at the bottom of the window.

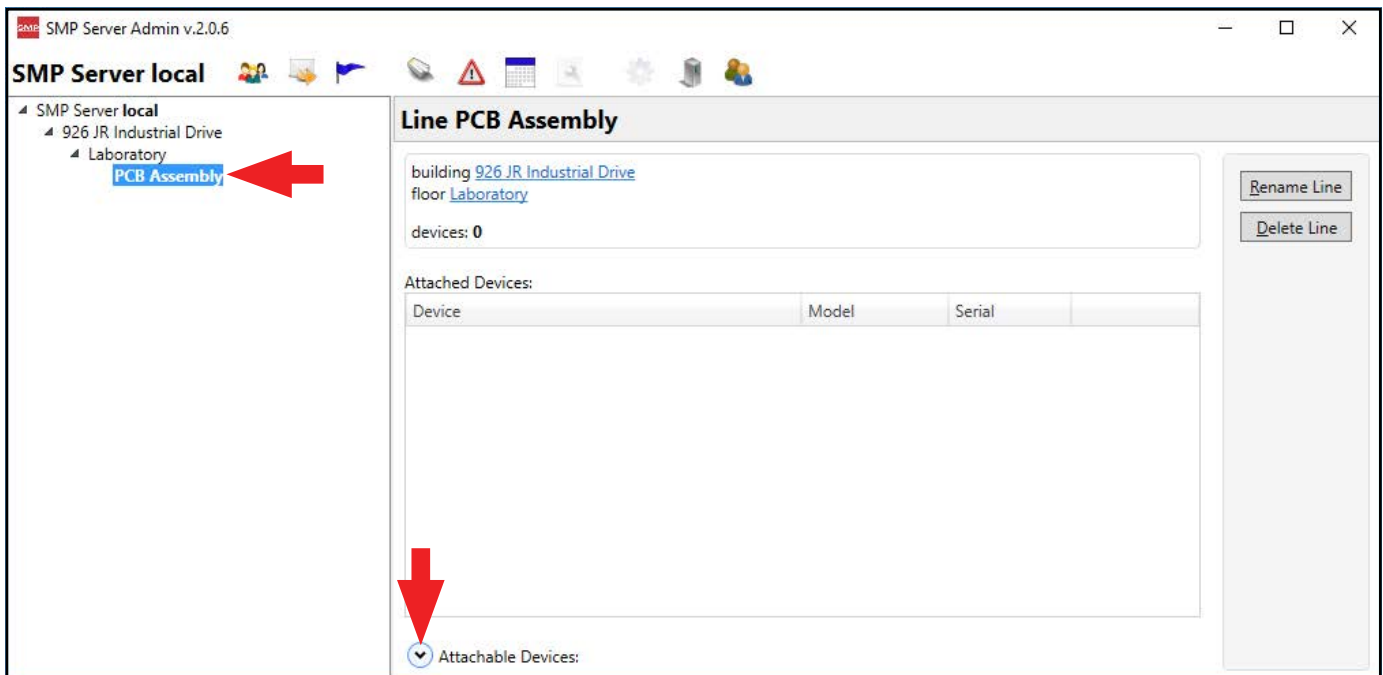

19. The serial number for the WS Aware Monitor will appear. This number will resemble the number found on the monitor's serial label with the exception of one zero. For example, if the serial number on the label says "XXXXX1725001", the serial number in SMP will read "XXXXXX172501".

Click attach.

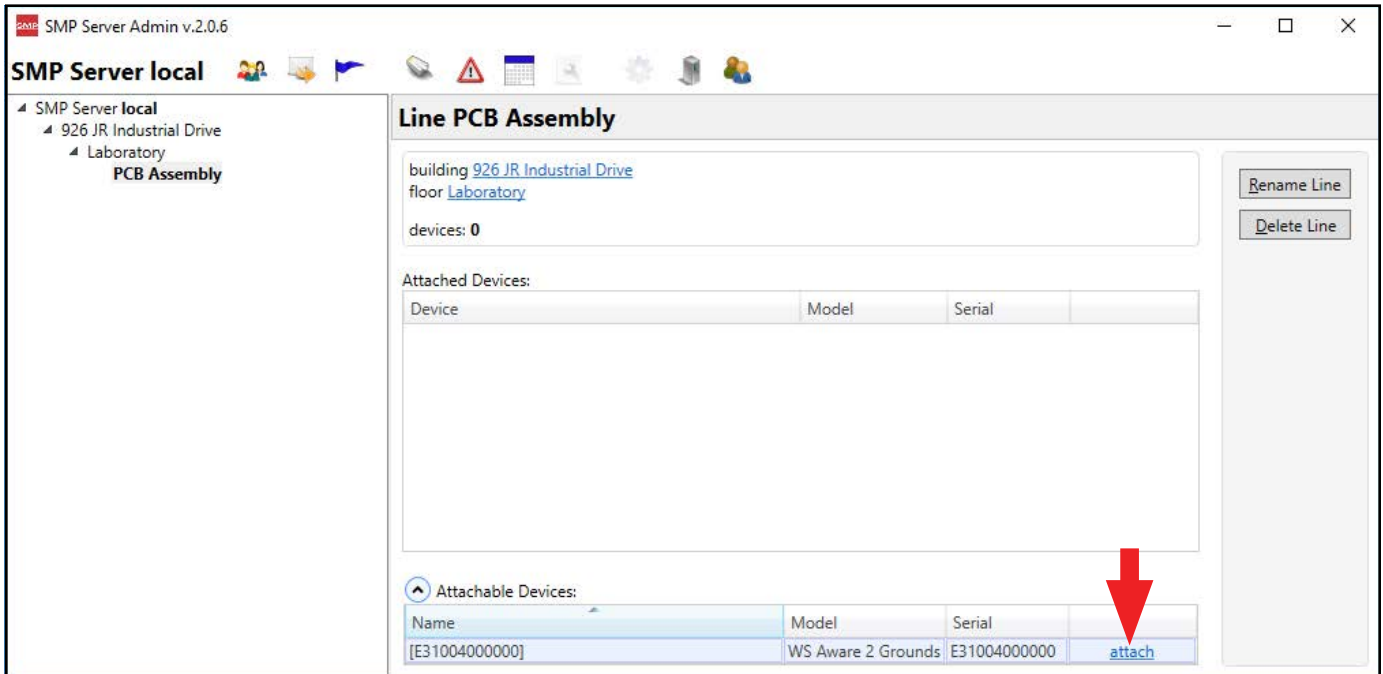

SMP Server Admin v.2.0.6

SMP Server local

- 926 JR Industrial Drive
 - Laboratory
 - PCB Assembly

Line PCB Assembly

building [926 JR Industrial Drive](#)
floor [Laboratory](#)

devices: 0

Attached Devices:

Device	Model	Serial	
[E31004000000]	WS Aware 2 Grounds	E31004000000	attach

Attachable Devices:

Name	Model	Serial	
[E31004000000]	WS Aware 2 Grounds	E31004000000	attach

[Rename Line](#)
[Delete Line](#)

20. The WS Aware Monitor will attach to the selected line.

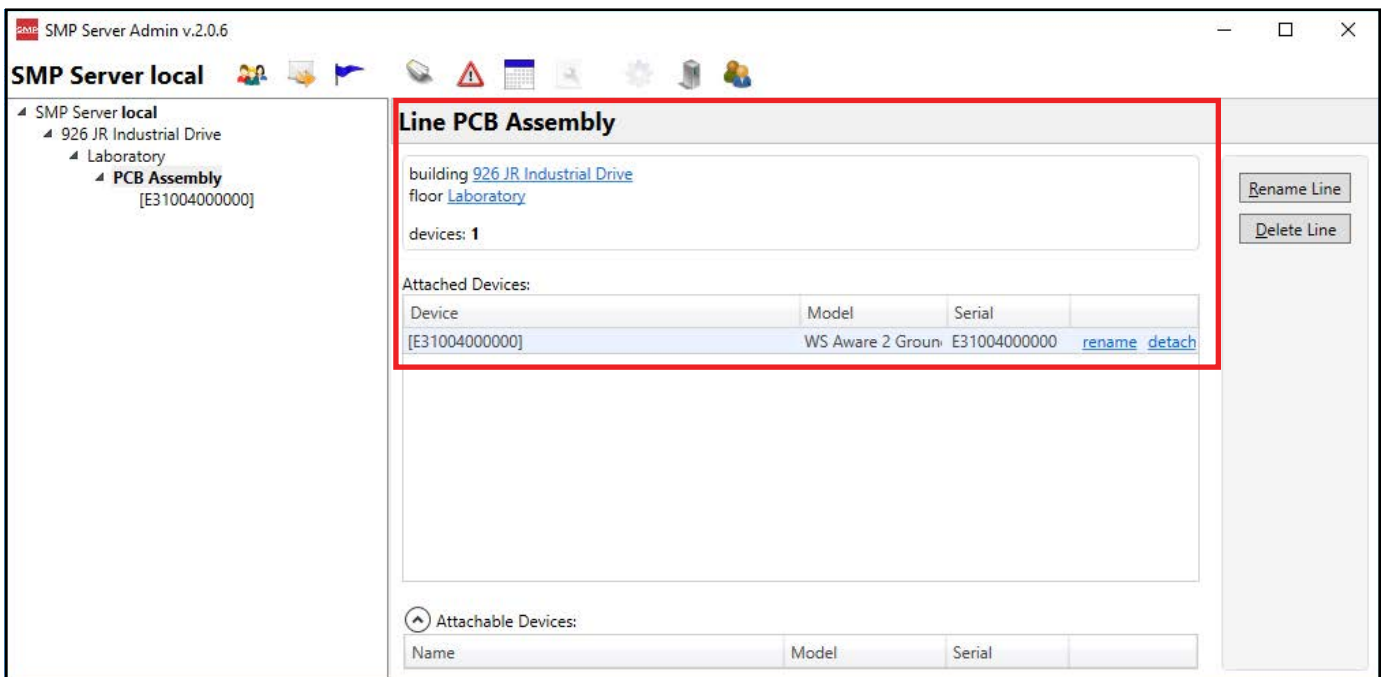

SMP Server Admin v.2.0.6

SMP Server local

- 926 JR Industrial Drive
 - Laboratory
 - PCB Assembly [E31004000000]

Line PCB Assembly

building [926 JR Industrial Drive](#)
floor [Laboratory](#)

devices: 1

Attached Devices:

Device	Model	Serial	
[E31004000000]	WS Aware 2 Groun	E31004000000	rename detach

Attachable Devices:

Name	Model	Serial	
------	-------	--------	--

[Rename Line](#)
[Delete Line](#)

21. Open SCS SMP Client.

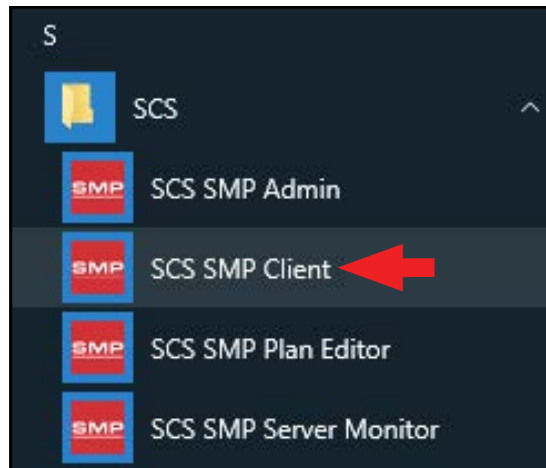

22. Verify that the WS Aware Monitor was added to the appropriate building, floor and line.

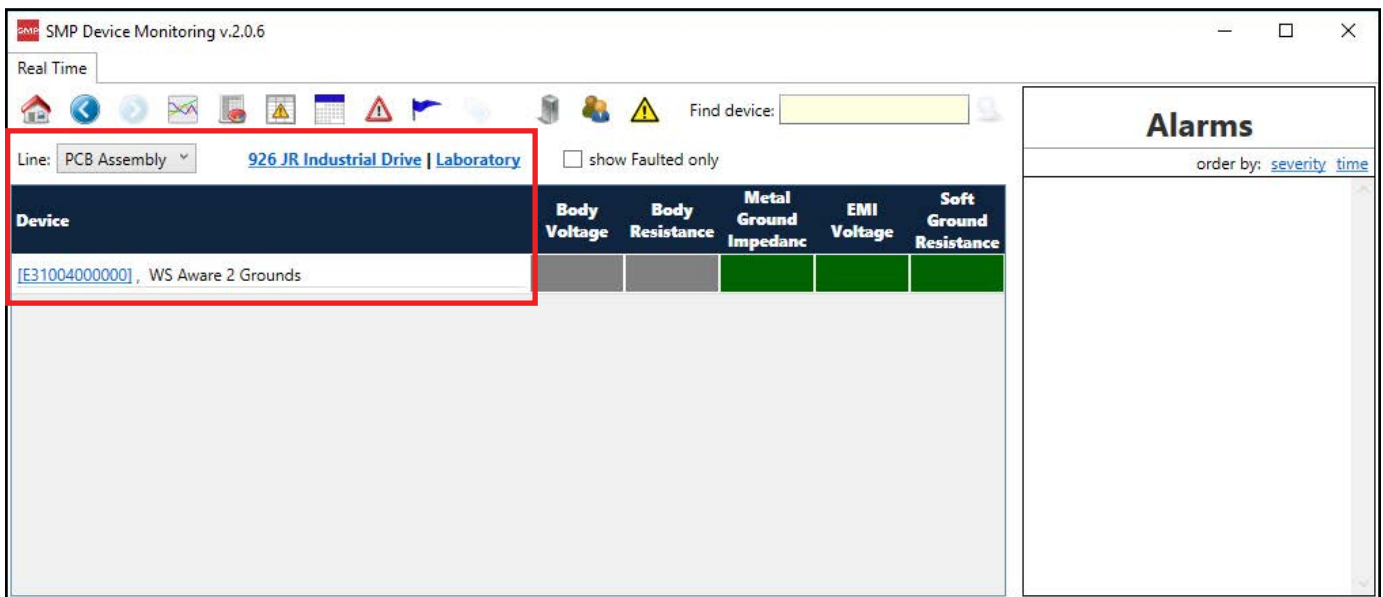

Operation

1. Fit the wristband snugly onto the wrist.
2. Snap the wrist cord to the wristband.
3. Plug the wrist cord into the operator remote's monitored jack labeled "OPERATOR". The corresponding operator LED will illuminate solid green on the WS Aware Monitor. This indicates that the operator is properly grounded.
4. If this does not happen, examine the wrist cord for continuity or damage and the wristband to ensure that it fits securely. If you have dry skin, apply an approved dissipative hand lotion such as [Menda Reztore™ ESD Hand Lotion](#).

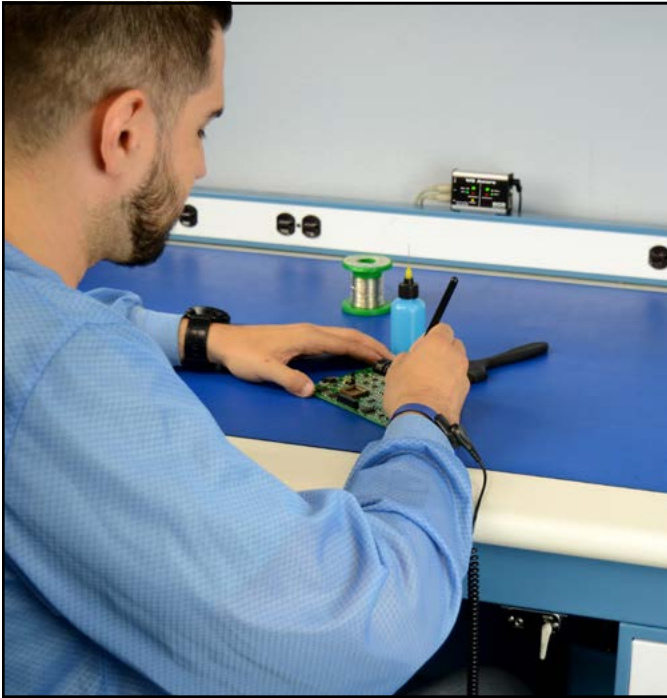

Figure 11. Using the 770061 WS Aware Monitor on a workbench

Maintenance

Cleaning

Disconnect the power adapter from the device. Clean the WS Aware Monitor and its operator remotes using a dry brush or vacuum cleaner. Clean its contacts using a contact cleaner or brush, and tighten all connections. Do not reconnect the power adapter until cleaning is finished.

Replacing the Operator Remote's Wrist Strap Jacks

Should the operator remote's wrist strap jacks begin to show wear and tear damage, they can be replaced using the SCS CTA245 Replacement Wrist Strap Jack PCB and the following procedure.

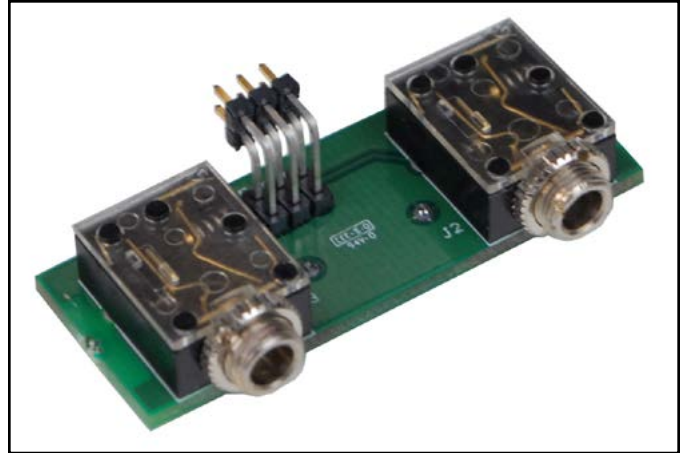

Figure 12. SCS CTA245 Replacement Wrist Strap Jack PCB for the WS Aware Monitor

1. Disconnect the power adapter from the WS Aware Monitor.
2. Disconnect the faulty operator remote from the WS Aware Monitor.
3. Access the two wrist strap jacks from the front of the operator remote. Remove the two collar nuts around the wrist strap jacks.
4. Remove the two phillips head screws located on the front of the front of the operator remote.
5. Remove the front lid from the operator remote.
6. Pull out the two PCB's from the aluminum enclosure.
7. Disconnect the PCB containing the two wrist strap jacks, and discard it. Replace it with the SCS CTA245 Replacement Wrist Strap Jack PCB.
8. Re-install the two PCB's into the operator remote's aluminum enclosure.
9. Re-install the front lid using the two phillips head screws.
10. Re-install the two collar nuts onto the wrist strap jacks.
11. Reconnect the operator remote to the WS Aware Monitor.
12. Reconnect the WS Aware to the power adapter.

Calibration

Frequency of recalibration should be based on the critical nature of those ESD sensitive items handled and the risk of failure for the ESD protective equipment and materials. In general, SCS recommends that calibration be performed annually.

Use the SCS CTE701 Workstation Monitor Checker to perform periodic verification (once every 6-12 months) of the WS Aware Monitor. The Workstation Monitor Checker can be used to check the test limits of the WS Aware Monitor without removing it from the factory floor.

See [TB-9031](#) for more information.



Figure 13. SCS CTE701 Workstation Monitor Checker

Specifications

Power

Power Adapter 100-240VAC 50-60 Hz	Output: 7.5 VDC @ 1.5 A Output Plug Polarization: Center Positive Output Plug: 5.5 mm O.D. x 2.1 mm I.D. x 9.5 mm L
---	---

Operator

Wrist Strap	Dual-Wire
Amount Monitored (Operator)	2
Amount Non-Monitored (Visitor)	2
Resistance Limit	10 megohms (default)
Programmable Resistance Range	2 to 35 megohms
Body Voltage Limit	±2.5 VDC (default)
Programmable Voltage Range	0 to ±5.0 VDC
Test Voltage	50 mV @ open circuit, peak-to-peak

Worksurface Mat

Amount Monitored	2
Resistance Limit	100 megohms (default)
Programmable Resistance Range	100 megohms to 1 gigohm

Metal Tool

Amount Monitored	2
Impedance Limit	10 ohms (default)
Programmable Impedance Range	1 to 20 ohms
EMI Voltage Limit	223 mV @ 1.8 MHz
Programmable EMI Range	1 to 1,000 mV

Connectivity

Input	Mini-DIN for operator remotes; 25-28 AWG wire terminal block for worksurface mats and metal tools
Outputs	RJ45 connector Ethernet output; Molex #53261-0371 connector for relay output

General

Alarm	LEDs and buzzer
Buzzer Sound Pressure Level	88 to 92 dBA
Dimensions (Monitor)	3.17" x 2.25" x 1.26" (81 mm x 57 mm x 32 mm)
Dimensions (Operator Remote)	2.41" x .84" x 1.13" (61 mm x 21 mm x 29 mm)
Operator Remote Cable Length	10 ft. (3 m)
Weight (Monitor)	0.3 lbs. (0.14 kg)
Weight (Operator Remote)	0.1 lbs. (0.05 kg)

Limited Warranty, Warranty Exclusions, Limit of Liability and RMA Request Instructions

See the SCS Warranty -

StaticControl.com/Limited-Warranty.aspx