

REV.	ECN NO.	DATE	SIGN	DESCRIPTION
B	LE3-6B0076	2006/10/31	Jerry	Remove the section & Change nut.
C	LEN1480599	2014/08/12	Rita	Update Logo

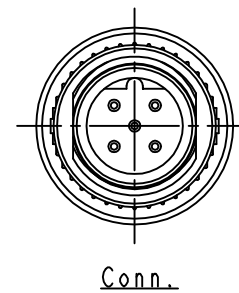
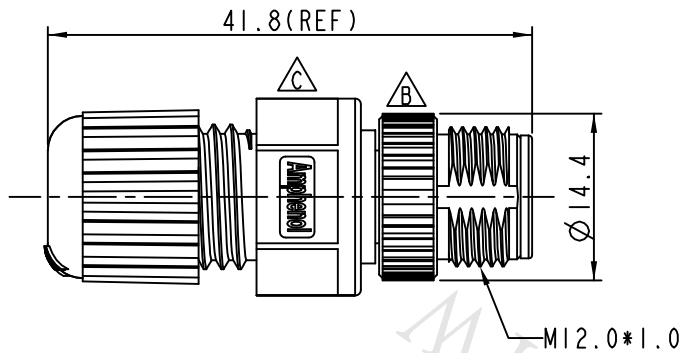
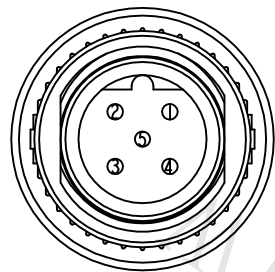
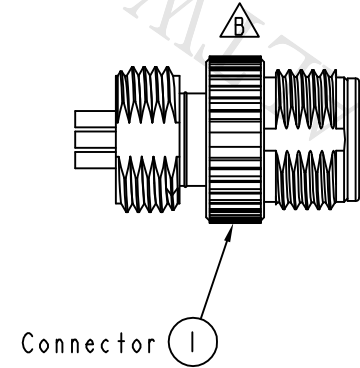
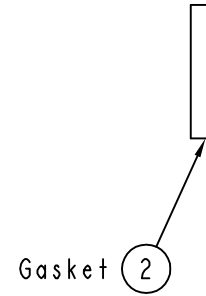
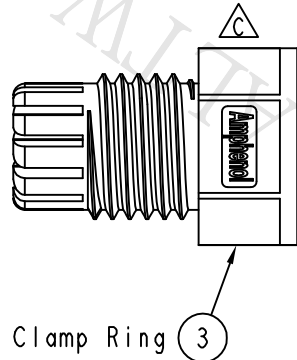
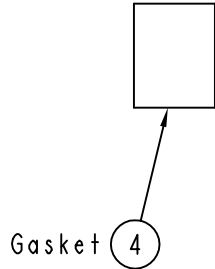
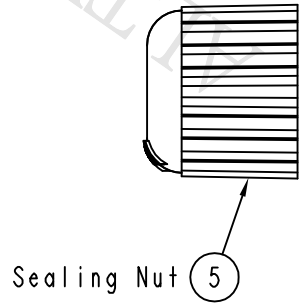

Notes:

- * Waterproof Rate: IP68
- * Housing: Black, Nylon+GF
- * Pin: Copper Alloy, Gold Plated
- * Nut: Zinc Alloy, Nickel Plated
- * Gasket: Black, EPDM
- * Clamp Ring: Black, Nylon
- * Sealing Nut: Black, Nylon
- * Seals: Black, EPDM
- * Seal For Cable OD: $\varnothing 4.5\text{mm} \sim \varnothing 6.5\text{mm}$

UNIT: mm	
TOLERANCE	
.X	± 0.25
.XX	± 0.1
.XXX	± 0.05
ANGLES	$\pm 1^\circ$

TITLE M12 B Code Assy Screw 5Pin M Conn M Pin			
SCALE 3:2	SIZE A4	SHEET 1 OF 1	
REV. C	WC-REV. A.4	QC: Inspection item	

Amphenol LTW
安費諾亮泰企業股份有限公司

ITEM NO 12B-05BMMA-SL8001	DRAWN BY Rita	DATE 2014-08-12
DWG NO 12B-05BMMA-SL8001	CHECKED BY Kris	DATE 2014-08-12
CUSTOMER ALTW	APPROVED BY Wenmao	DATE 2014-08-12

THIS DOCUMENT IS SUBJECT TO CHANGE WITHOUT NOTICE. IT IS CONFIDENTIAL AND A PROPERTY OF Amphenol LTW. DISCLOSURE TO THIRD PARTY HAS TO BE AUTHORIZED BY Amphenol LTW.