

SMU Series

SMD, single-turn, sealed cermet trimmers



- Available in J-hook and gull-wing terminal configurations
- Meets EIA, EIAJ, IPC, VECI standard SMD trimmer designs
- Pb-free and Cd-free construction
- RoHS compliant
- Gold-plated leads provide high conductivity, low contact resistance, high corrosion resistance and good solderability
- Top cross-slot adjustment (top single-slot models available as special order)
- Tape and reel packaging



SERIES SPECIFICATIONS

Series	Wattage	Manufactured Range (Ω)	Rotation	Adj. Location	Taper	Tolerance
SMUA	0.125	50-2M	$250^\circ \pm 10^\circ$	Top	Linear	20%
SMUB	0.25	50-2M	$250^\circ \pm 10^\circ$	Top	Linear	20%

CHARACTERISTICS

Standard Resistance Range	50 Ω to 2M Ω (standard 1, 2 & 5 sequence)
Resistance Tolerance	$\pm 20\%$ standard
End Resistance	1% or 3 Ω , whichever is greater
Temp. Range	-55 $^\circ$ C to +125 $^\circ$ C
Resistance Taper	Linear
Peak Noise (C.R.V.)	2% or 3 Ω , whichever is greater
Power Rating	SMUA 0.125w @70 $^\circ$ C; 0w @+125 $^\circ$ C SMUB 0.250w @70 $^\circ$ C; 0w @+125 $^\circ$ C
Maximum Input Voltage	200VDC or power rating, whichever is smaller
Temperature Coefficient	± 100 ppm/ $^\circ$ C, 200 Ω to 1M Ω ± 250 ppm/ $^\circ$ C, other values
Insulation Resistance	100M Ω minimum at 500VDC
Dielectric Strength	500VAC, 1 minute
Adjustment Travel	$250^\circ \pm 10^\circ$
Mechanical Travel	$250^\circ \pm 10^\circ$
Shaft Torque	0 gf \cdot cm (0.69 oz \cdot in) max.
Stop Strength	200 gf \cdot cm (2.77 oz \cdot in) min.
Flammability of Plastic Materials	Meets UL 94V-0
Nominal Weight	0.068g
Marking	Resistance value or code, date code

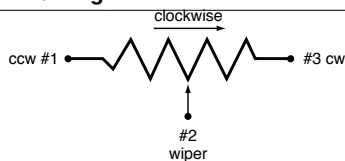

Low Temperature Operation	-55 $^\circ$ C, 0.125 watt, 1 hour	$\Delta T/R \leq \pm 2\%$, S.S. $\leq \pm 2\%$
High Temp. Exposure	+125 $^\circ$ C, 250 hours	$\Delta T/R \leq \pm 2\%$, S.S. $\leq \pm 2\%$
Load Life	+70 $^\circ$ C, 0.125 watt, 1,000 hours	$\Delta T/R \leq \pm 3\%$, S.S. $\leq \pm 2\%$
Thermal Shock	-55 $^\circ$ C, +125 $^\circ$ C, 30 minutes each, 5 cycles	$\Delta T/R \leq \pm 2\%$, S.S. $\leq \pm 1\%$
Shock	100G, 6ms, 6 directions, 3 times each	$\Delta T/R \leq \pm 1\%$, S.S. $\leq \pm 1\%$
Vibration	10-2,000Hz, 1.5mm amplitude, 20G, 12 hours	$\Delta T/R \leq \pm 1\%$, S.S. $\leq \pm 1\%$
Humidity	+40 $^\circ$ C, 90-95%RH, 0.125 watt, 500 hours	$\Delta T/R \leq \pm 3\%$, S.S. $\leq \pm 2\%$
Moisture Resistance	-10 $^\circ$ C to +65 $^\circ$ C, 80-98%RH, 0.125 watt, 10 cycles, 240 hours	$\Delta T/R \leq \pm 3\%$
Soldering Heat Resistance	240 $^\circ$ C, 10 seconds	$\Delta T/R \leq \pm 1\%$
Seal Test	+85 $^\circ$ C, hot water for 1 minute	
Rotational Life	100 cycles without discontinuity, no load	$\Delta T/R \leq \pm 5\%$

Position of Rotor Inside

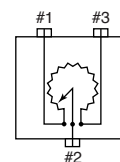

Outside Markings

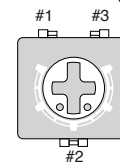

SMU Series

SMD, single-turn, sealed cermet trimmers

CHARACTERISTICS

(continued)

Flow Soldering Profile

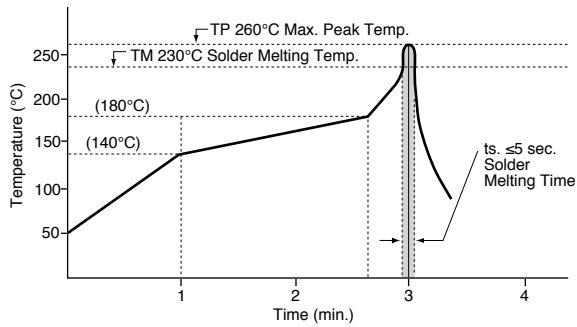

Reflow Soldering Profile

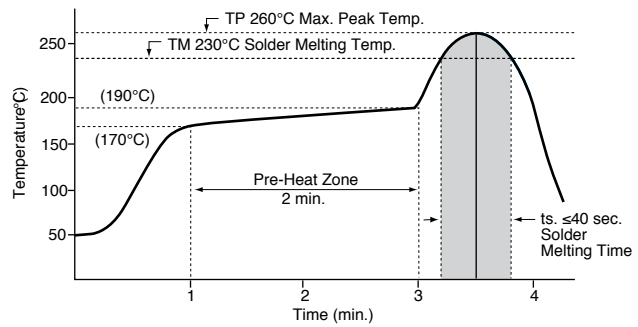

DIMENSIONS

(mm)

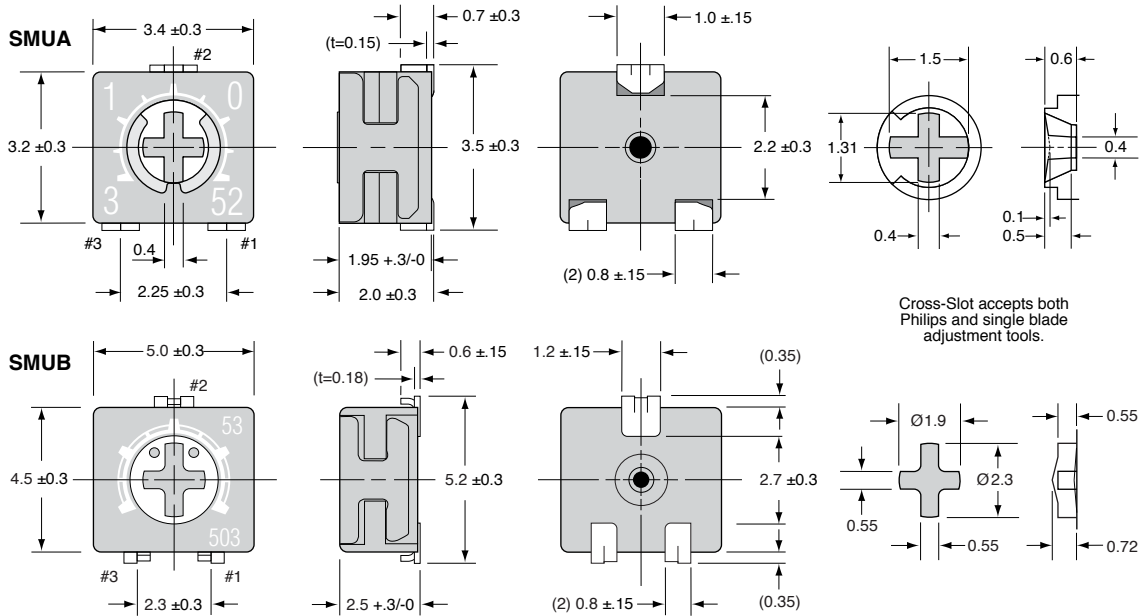

Land Pattern

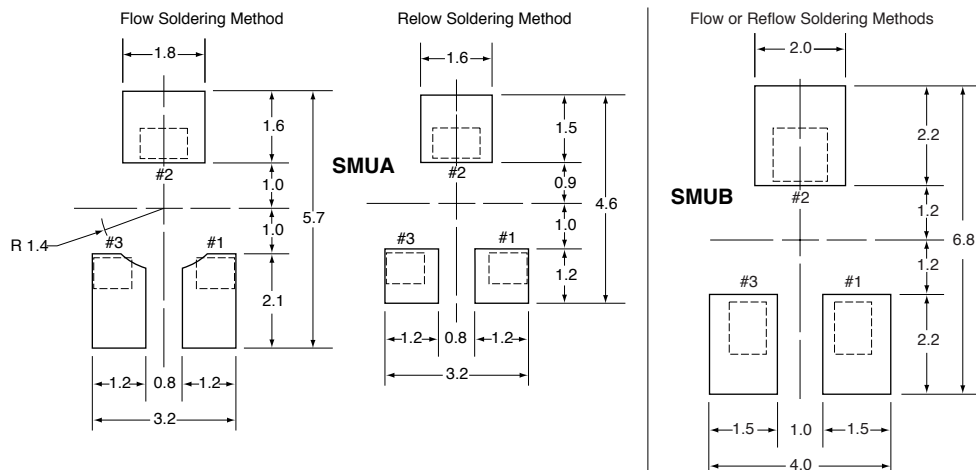

SMU Series

SMD, single-turn, sealed cermet trimmers

TAPE AND REEL

(mm)

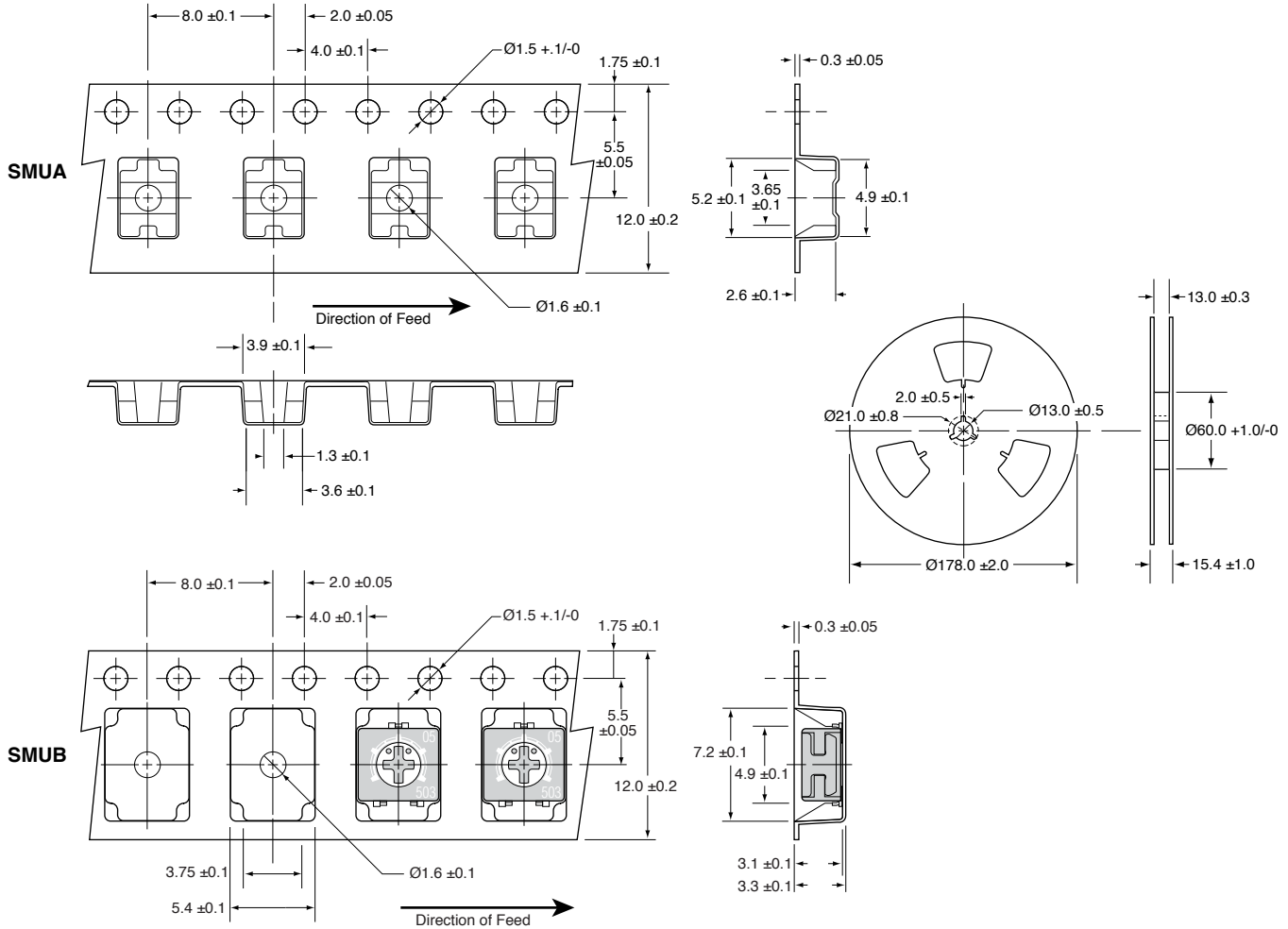

ORDERING INFORMATION

Adj. location
RoHS compliant
Tape & reel 500 pcs/reel

SMUA104PET

Surface mount potentiometer
Terminal type
Wattage A = 0.125 B = 0.250
Ohms
Tolerance P = 20%

Standard Part Numbers

SMUA500PET	SMUB500PET
SMUA101PET	SMUB101PET
SMUA201PET	SMUB201PET
SMUA501PET	SMUB501PET
SMUA102PET	SMUB102PET
SMUA202PET	SMUB202PET
SMUA502PET	SMUB502PET
SMUA103PET	SMUB103PET
SMUA203PET	SMUB203PET
SMUA503PET	SMUB503PET
SMUA104PET	SMUB104PET
SMUA204PET	SMUB204PET
SMUA504PET	SMUB504PET
SMUA105PET	SMUB105PET