



TMR 48 analogue timers TMR 48 X Part number 88886116



- Multi-function or mono-function
- Multi-range from 0.02 s to 300 h
- Multi-voltage 12 to 240 VDC / 24 to 240 V AC
- Time setting displayed on dial
- 2 changeover relays 5 A / 250 VAC
- Display of power and output states by 2 LEDs
- Housing 48 x 48 mm

Part numbers

Type	Max. breaking current	Functions	Connection	Relay outputs	Supply voltage
88 886 116 TMR 48 X	5 A / 250 VAC	A1, A2, H1, H2, Q1, Q2, D-Di	Plug-in 8 way	2 changeover or 1 timed and 1 instantaneous	12 →240 VDC 24 →240 VAC

Specifications

Supply voltage Un	12 →240 VDC 24 →240 V AC
Operating range	± 10 % DC supply - 15 % / + 10 % AC supply
Frequency	50 / 60 Hz
Power consumption	4.8 VA / 230 VAC 2.5 VA / 110 VAC 1.1 VA / 24 VAC 0.5 W / 24 VDC 0.8 W / 12 VDC
Timing ranges (14 available options)	0,02 →1,2 s 0,05 →3 s 0,2 →12 s 0,5 →30 s 2 →120 s 5 →300 s 0,2 →12 min. 0,5 →30 min. 2 →120 min. 5 →300 min. 0,2 →12 h 0,5 →30 h 2 →120 h 5 →300 h
Repetition accuracy	± 0.5 % of full scale at 25 °C (typical with constant parameters)
Temperature drift according to CEI/EN 61812	± 0.05 % of full scale
Display precision	± 5 % of full scale at 25 °C
Minimum pulse duration START	25 ms
Minimum pulse duration GATE	60 ms
Minimum pulse duration RESET	60 ms
Retard à la disponibilité par coupure de tension (START strappé)	50 ms
Nominal rating	2 x 5 A
Nominal insulation voltage	250 VAC
Rated power (resistive load)	2000 VA
Minimum current	10 mA
Electrical life at I max. 250 V AC resistive (number of operations)	10 ⁵
Mechanical life (operations)	30 x 10 ⁶
Display of output state by 2 LEDs	Green : power ON flashing during timing Yellow : ON output ON OFF output OFF
Operating temperature range (°C)	-20 →+55
Storage temperature range (°C)	-40 →+70
Breakdown voltage	2 KV
Protection class (IEC 60529) - Panel-mounted	IP 50
Protection class (IEC EN/60529) - Casing	IP 40
Housing material	self-extinguishing
Weight (g)	140

Accessories

Accessories	Code

11-pin connector base	25622080
8-pin connector base	25622130
Spring clips (pack of 2)	79237739
*** TRADUCTION MANQUANTE ***	•

Dimensions (mm)

TMR 48 U / A / X / L

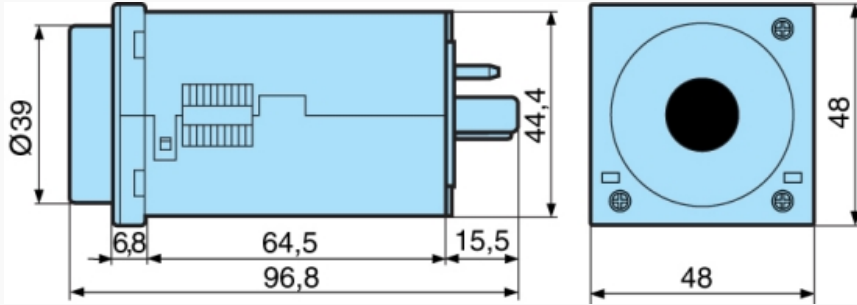

Dimensions (mm)

35 mm DIN rail base with clips 79 237 739

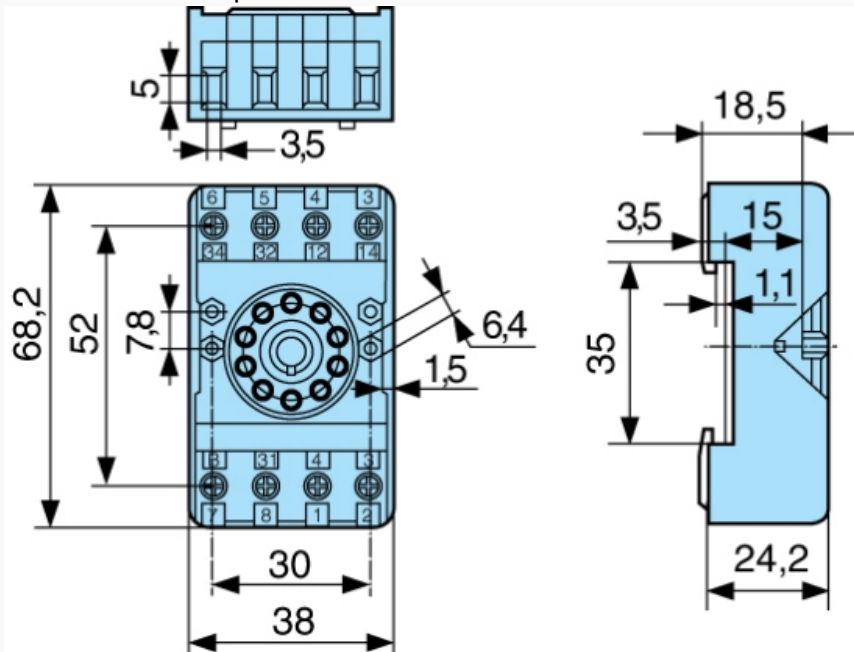

Dimensions (mm)

Panel cut-out

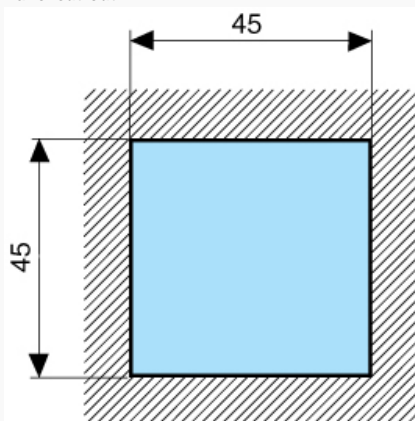

Curves

Function A1

Delay on energisation

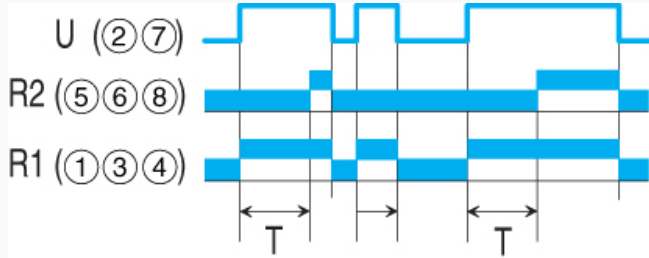

Curves

Function A2

Delay on energisation

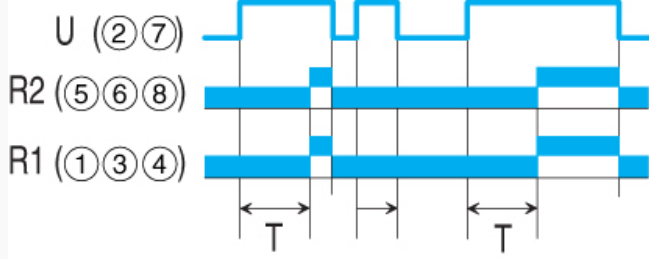

Curves

Function H1

Timing on energisation

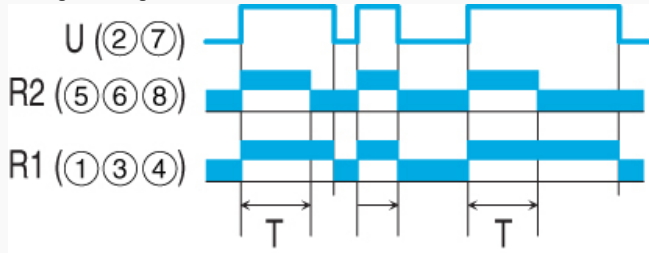

Curves

Function H2

Timing on energisation

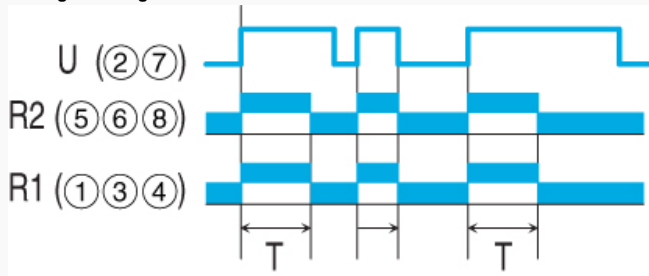

Curves

Function Q1

Star-delta

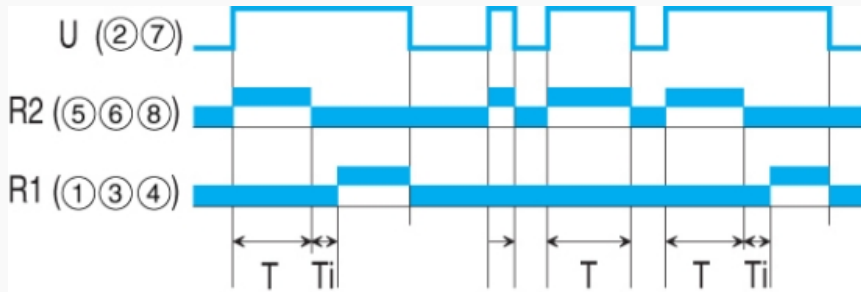

Curves

Function Q2

Star-delta 2

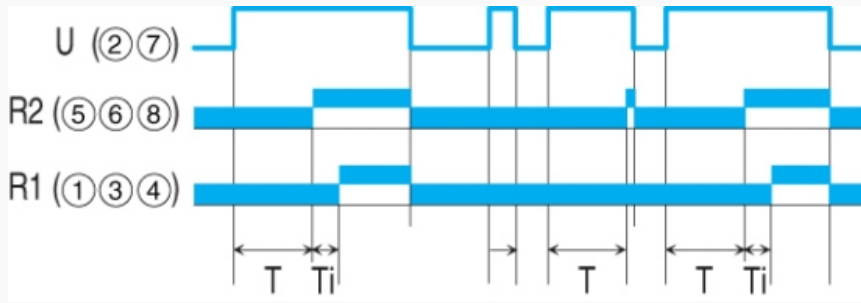

Curves

Function D-Di

Cyclic timing : symetric recycler

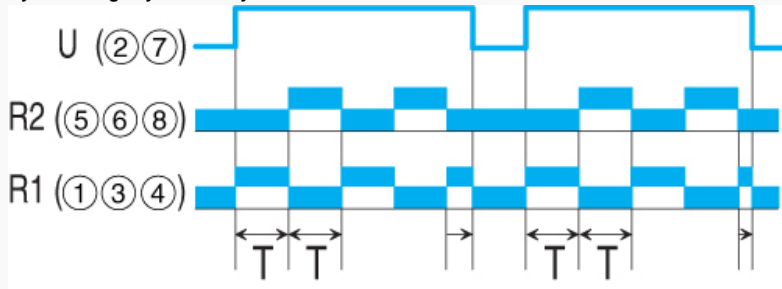

Connections

TMR 48 X

