

IEC Appliance Inlet C14 with Line Switch, Fuseholder 1- or 2-pole, Voltage Selector (series-parallel), "Lock and Shield" Mounting,



GRM2: only with shield, without line filter



Description

- Panel Mount:
Snap-in version from rear-side
- 5 Functions:
Appliance Inlet Protection class I, Line Switch 2-pole, with or without Fuseholder for fuse-links 5 x 20 mm, with or without voltage selector, with EMC-shield

Approvals

- VDE Certificate Number: 40024784
- UL File Number: E93617

Characteristics

- Ultra-compact design
Time saving "Lock and Shield" snap-in design for rear-panel mounting
- All single elements are already wired
- Fuseholder on the inside of the equipment prevents accidental use of incorrect fuse-links by the user
- Voltage selector for two voltage ranges
Innovative EMC-shielding with flexible steel segments for an excellent contact to the panel
- Insulation cover on the rear-side
- Qualified for use in equipment according IEC/EN 60950

Other versions on request

- Panel thickness 1.0 / 2 / 2.5 mm (max.)
- Fuseholder 1-pole
- Line switch 1-pole
- Voltage selector with other marking

References

This type is Phase-out without alternate type
Last order date: 30.09.2013

Weblinks

[pdf-datasheet](#), [html-datasheet](#), [General Product Information](#), [Approvals](#), [RoHS](#), [CHINA-RoHS](#), [Mating Connectors](#), [e-Shop](#), [SCHURTER-Stock-Check](#), [Distributor-Stock-Check](#), [CAD-Drawings](#), [Accessories](#), [Detailed request for product](#)

Newly available variants corresponding to V-Lock mating cordset. The connector is equipped with a notch intended for use with the latching cordset. The cord latching system prevents against accidental removal of the cordset.

Technical Data

Ratings IEC	10A @ Ta 40 °C / 250VAC; 50Hz	Appliance-Inlet/-Outlet	C14 acc. to IEC 60320, UL 498, CSA C22.2 no. 42 (for cold conditions) pin-temperature 70 °C, 10A, Protection Class I
Ratings UL/CSA	10A @ Ta 40 °C / 125VAC; 60Hz	Fuseholder	1 or 2 pole, Shocksafe category PC2 acc. to IEC 60127-6, for fuse-links 5 x 20mm
Dielectric Strength	> 1.7 kVDC between L-N > 2.7 kVDC between L/N-PE Test voltage (2 sec)	Rated Power Acceptance @ Ta 23 °C	5 x 20: 2 W (1 pole)/ 1.6 W (2-pole) per pole
Allowable Operation Temp.	-25 °C to 85 °C	Power Acceptance @ Ta > 23 °C	Admissible power acceptance at higher ambient temperature see derating curves
Climatic Category	25/085/21 acc. to IEC 60068-1	Line Switch	Rocker switch 2-pole, non-illuminated, acc. to IEC 61058-1 Technical Details
Degree of Protection	from front side IP 40 acc. to IEC 60529	Voltage Selectors	optional, jumper, 2 pos.
Protection Class	Suitable for appliances with protection class I acc. to IEC 61140	MTBF	> 1'400'000h acc. to MIL-HB-217 F
Terminal	Quick connect terminals 4.8 x 0.8 mm Solder terminal on request Solder terminals for voltage selector		
Panel Thickness s	Snap-in: 1.5 mm (other on request)		
Material: Housing	Thermoplastic, black, UL 94V-0		

Dimensions
GRM2

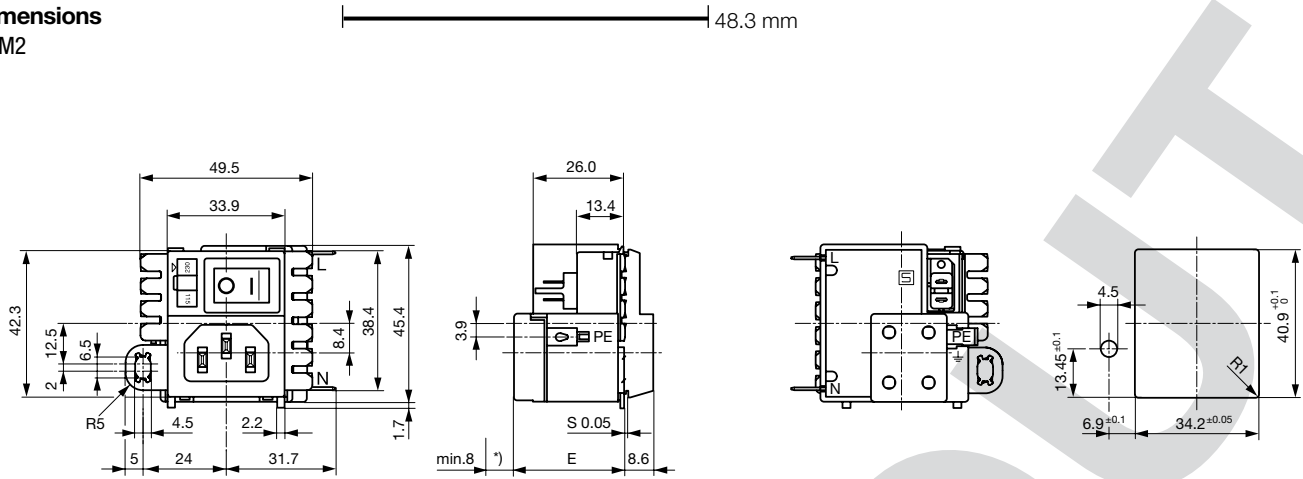

Dimensions
Step 1

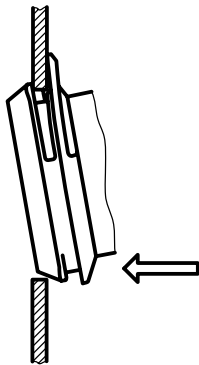

Place the socket in top edge of the panel cut-out.

Step 2

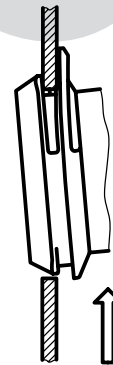

Push the socket upwards.

Step 3

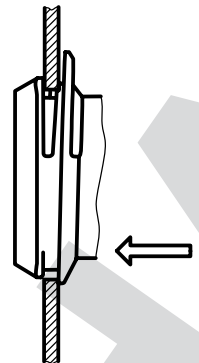

Push the socket forward into the panel cut-out.

Step 4

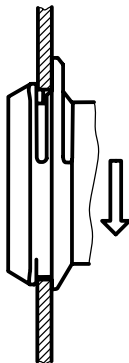

Release the socket. The component is self adjusting.

Diagrams

Voltage selector

GRM2

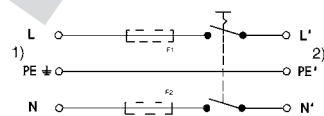
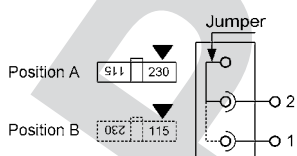

1) Line
2) Load

Derating Curves

1-pole

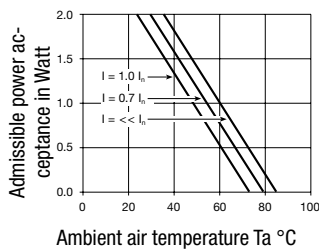

2-pole

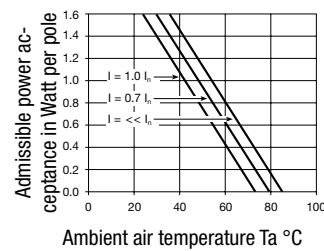

Variants

Basic version:

- Marking of the voltage selector 115/230
- with housing and cover on the rear-side

Rated Current [A]	Filter-Type	Fuseholder	Line Switch	Voltage Selectors	Order Number
10	without	-	2-pole		GRM2.1160.013
10	without	-	2-pole	●	GRM2.1161.023
10	without	2-pole	2-pole		GRM2.1180.013
10	without	2-pole	2-pole	●	GRM2.1181.023

Packaging unit 20 Pcs

Mating Outlets/Connectors

Category / Description

Appliance Outlet Overview complete



IEC Appliance Outlet F, Screw-on Mounting, Front Side, Solder Terminal	4787
IEC Appliance Outlet F, Snap-in Mounting, Front Side, Solder or Quick-connect Terminal	4788
IEC Appliance Outlet F or H, Screw-on Mounting, Front Side, Solder, PCB or Quick-connect Terminal	5091
IEC Appliance Outlet F or H, Screw-on Mounting, Front Side, Solder or Quick-connect Terminal	5092

[Appliance Outlet further types to GRM2](#)

Connector Overview complete



IEC Connector C15, Rewireable, Straight	0101
IEC Connector C15A, Rewireable, Straight	0102
IEC Connector C15A, Rewireable, Straight	0102-G
IEC Connector C15A, Rewireable, Angled	0112
IEC Connector C13, Rewireable, Angled	4012

[Connector further types to GRM2](#)

Power Cord Overview complete



Power Cord with IEC Connector C13, Angled	0311
Power Cord with IEC Connector C13, Angled	3011
Power Cord with IEC Connector C13, Angled	3012
Power Cord with IEC Connector C13, Angled	3013
Power Cord with IEC Connector C13	3020

[Power Cord further types to GRM2](#)