



RF Power Field Effect Transistors

N-Channel Enhancement-Mode Lateral MOSFETs

RF power transistors designed for applications operating at frequencies from 900 to 1215 MHz. These devices are suitable for use in defense and commercial pulse applications, such as IFF and DME.

- Typical Pulse Performance: $V_{DD} = 50$ Vdc, $I_{DQ} = 100$ mA, $P_{out} = 275$ W Peak (27.5 Watts Avg.), $f = 1030$ MHz, Pulse Width = 128 μ sec, Duty Cycle = 10%
 Power Gain — 20.3 dB
 Drain Efficiency — 65.5%
- Capable of Handling 10:1 VSWR, @ 50 Vdc, 1030 MHz, 275 W Peak Power
- Typical Broadband Performance: $V_{DD} = 50$ Vdc, $I_{DQ} = 100$ mA, $P_{out} = 250$ W Peak (25 Watts Avg.), $f = 960$ -1215 MHz, Pulse Width = 128 μ sec, Duty Cycle = 10%
 Power Gain — 19.8 dB
 Drain Efficiency — 58%

Features

- Characterized with Series Equivalent Large-Signal Impedance Parameters
- Internally Matched for Ease of Use
- Qualified up to a Maximum of 50 V_{DD} Operation
- Integrated ESD Protection
- Greater Negative Gate-Source Voltage Range for Improved Class C Operation

MMRF1008H
MMRF1008HS
MMRF1008GH

960-1215 MHz, 275 W, 50 V
PULSE
LATERAL N-CHANNEL
RF POWER MOSFETs

NI-780H-2L
MMRF1008H



NI-780S-2L
MMRF1008HS

NI-780GH-2L
MMRF1008GH

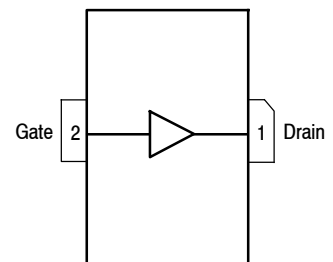

(Top View)

Note: The backside of the package is the source terminal for the transistor.

Figure 1. Pin Connections



Table 1. Maximum Ratings

Rating	Symbol	Value	Unit
Drain-Source Voltage	V_{DSS}	-0.5, +100	Vdc
Gate-Source Voltage	V_{GS}	-6.0, +10	Vdc
Storage Temperature Range	T_{stg}	-65 to +150	°C
Case Operating Temperature	T_C	150	°C
Operating Junction Temperature (1)	T_J	225	°C

Table 2. Thermal Characteristics

Characteristic	Symbol	Value (2)	Unit
Thermal Resistance, Junction to Case Case Temperature 80°C, 275 W Peak 128 μ sec Pulse Width, 10% Duty Cycle, 50 Vdc, $I_{DQ} = 100$ mA, 1030 MHz	$Z_{\theta JC}$	0.08	°C/W

Table 3. ESD Protection Characteristics

Test Methodology	Class
Human Body Model (per JESD22-A114)	2, passes 2600 V
Machine Model (per EIA/JESD22-A115)	B, passes 200 V
Charge Device Model (per JESD22-C101)	IV, passes 2000 V

Table 4. Electrical Characteristics ($T_A = 25^\circ\text{C}$ unless otherwise noted)

Characteristic	Symbol	Min	Typ	Max	Unit
----------------	--------	-----	-----	-----	------

Off Characteristics

Gate-Source Leakage Current ($V_{GS} = 5$ Vdc, $V_{DS} = 0$ Vdc)	I_{GSS}	—	—	10	μ Adc
Drain-Source Breakdown Voltage ($V_{GS} = 0$ Vdc, $I_D = 100$ mA)	$V_{(BR)DSS}$	110	—	—	Vdc
Zero Gate Voltage Drain Leakage Current ($V_{DS} = 50$ Vdc, $V_{GS} = 0$ Vdc)	I_{DSS}	—	—	10	μ Adc
Zero Gate Voltage Drain Leakage Current ($V_{DS} = 90$ Vdc, $V_{GS} = 0$ Vdc)	I_{DSS}	—	—	100	μ Adc

On Characteristics

Gate Threshold Voltage ($V_{DS} = 10$ Vdc, $I_D = 662$ μ Adc)	$V_{GS(th)}$	0.9	1.7	2.4	Vdc
Gate Quiescent Voltage ($V_{DD} = 50$ Vdc, $I_D = 100$ mAdc, Measured in Functional Test)	$V_{GS(Q)}$	1.7	2.4	3.2	Vdc
Drain-Source On-Voltage ($V_{GS} = 10$ Vdc, $I_D = 1.6$ Adc)	$V_{DS(on)}$	—	0.25	—	Vdc

Dynamic Characteristics (3)

Reverse Transfer Capacitance ($V_{DS} = 50$ Vdc \pm 30 mV(rms)ac @ 1 MHz, $V_{GS} = 0$ Vdc)	C_{rss}	—	0.46	—	pF
Output Capacitance ($V_{DS} = 50$ Vdc \pm 30 mV(rms)ac @ 1 MHz, $V_{GS} = 0$ Vdc)	C_{oss}	—	352	—	pF
Input Capacitance ($V_{DS} = 50$ Vdc, $V_{GS} = 0$ Vdc \pm 30 mV(rms)ac @ 1 MHz)	C_{iss}	—	695	—	pF

1. Continuous use at maximum temperature will affect MTTF.
2. Refer to AN1955, *Thermal Measurement Methodology of RF Power Amplifiers*. Go to <http://www.nxp.com/RF> and search for AN1955.
3. Part internally matched both on input and output.

(continued)

Table 4. Electrical Characteristics ($T_A = 25^\circ\text{C}$ unless otherwise noted) (continued)

Characteristic	Symbol	Min	Typ	Max	Unit
Functional Tests ⁽¹⁾ (In Freescale Test Fixture, 50 ohm system) $V_{DD} = 50\text{ Vdc}$, $I_{DQ} = 100\text{ mA}$, $P_{out} = 275\text{ W Peak}$ (27.5 W Avg.), $f = 1030\text{ MHz}$, Pulse, 128 μsec Pulse Width, 10% Duty Cycle					
Power Gain	G_{ps}	19	20.3	22	dB
Drain Efficiency	η_D	63	65.5	—	%
Input Return Loss	IRL	—	-14	-9	dB

Typical Broadband Performance — 960-1215 MHz (In Freescale 960-1215 MHz Test Fixture, 50 ohm system) $V_{DD} = 50\text{ Vdc}$, $I_{DQ} = 100\text{ mA}$, $P_{out} = 250\text{ W Peak}$ (25 W Avg.), $f = 960\text{-}1215\text{ MHz}$, Pulse, 128 μsec Pulse Width, 10% Duty Cycle

Power Gain	G_{ps}	—	19.8	—	dB
Drain Efficiency	η_D	—	58	—	%

Table 5. Ordering Information

Device	Tape and Reel Information	Package
MMRF1008HR5	R5 Suffix = 50 Units, 56 mm Tape Width, 13-inch Reel	NI-780H-2L
MMRF1008HSR5		NI-780S-2L
MMRF1008GHR5		NI-780GH-2L

- Measurements made with device in straight lead configuration before any lead forming operation is applied. Lead forming is used for gull wing (GH) parts.

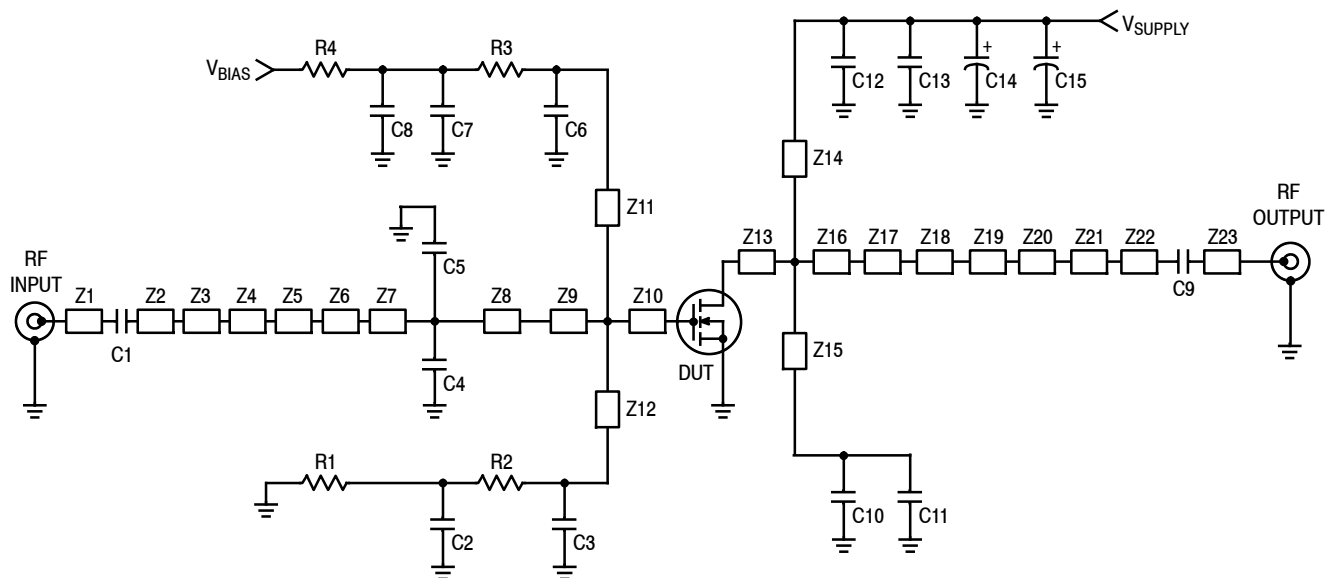

Z1	1.055" x 0.082" Microstrip	Z13	0.190" x 1.250" Microstrip
Z2	0.100" x 0.082" Microstrip	Z14, Z15	0.517" x 0.080" Microstrip
Z3	0.084" x 0.395" Microstrip	Z16	0.225" x 1.250" Microstrip
Z4	0.419" x 0.040" Microstrip	Z17	0.860" x 0.975" Microstrip
Z5	0.498" x 0.466" Microstrip	Z18	0.140" x 0.950" Microstrip
Z6	0.110" x 1.060" Microstrip	Z19	0.028" x 0.110" Microstrip
Z7	0.050" x 1.300" Microstrip	Z20	0.397" x 0.040" Microstrip
Z8	0.092" x 1.300" Microstrip	Z21	0.264" x 0.480" Microstrip
Z9	0.219" x 1.420" Microstrip	Z22	0.100" x 0.082" Microstrip
Z10	0.087" x 1.420" Microstrip	Z23	0.521" x 0.082" Microstrip
Z11, Z12	0.187" x 0.050" Microstrip	PCB	Arlon CuClad 250GX-0300-55-22, 0.030", $\epsilon_r = 2.55$

Figure 2. MMRF1008H(HS) Test Circuit Schematic

Table 6. MMRF1008H(HS) Test Circuit Component Designations and Values

Part	Description	Part Number	Manufacturer
C1, C4, C5	1.5 pF Chip Capacitors	ATC100B1R5BT500XT	ATC
C2, C7, C11, C13	2.2 μ F, 100 V Chip Capacitors	G2225X7R225KT3AB	ATC
C3, C6, C10, C12	33 pF Chip Capacitors	ATC100B330JT500XT	ATC
C8	22 μ F, 25 V Chip Capacitor	TPSD226M025R0200	AVX
C9	9.1 pF Chip Capacitor	ATC100B9R1CT500XT	ATC
C14, C15	470 μ F, 63 V Electrolytic Capacitors	MCGPA63V477M13X26-RH	Multicomp
R1, R2, R3, R4	0 Ω , 3.5 A Chip Resistors	CRCW12060000Z0EA	Vishay

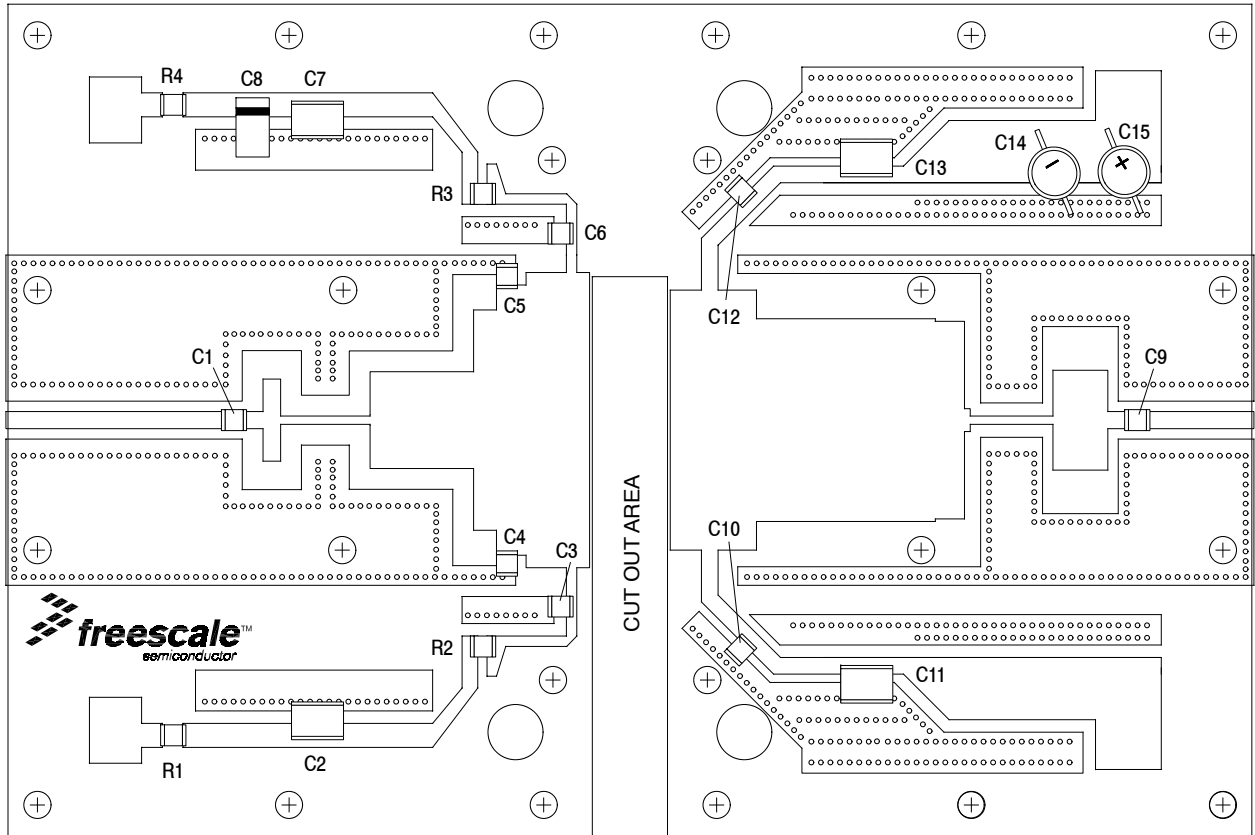

Figure 3. MMRF1008H(HS) Test Circuit Component Layout

TYPICAL CHARACTERISTICS

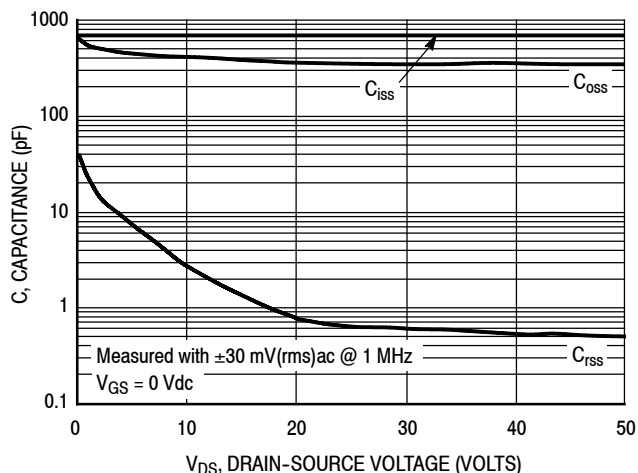

Figure 4. Capacitance versus Drain-Source Voltage

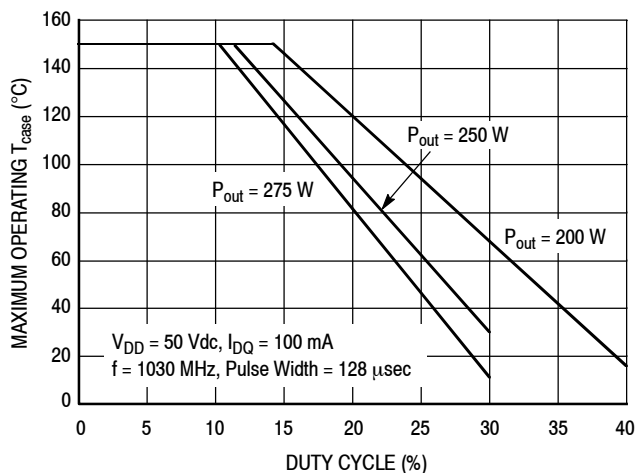

Figure 5. Safe Operating Area

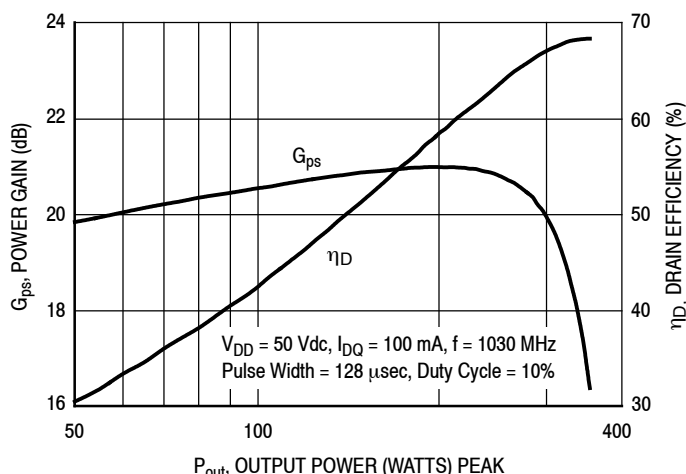

Figure 6. Power Gain and Drain Efficiency versus Output Power

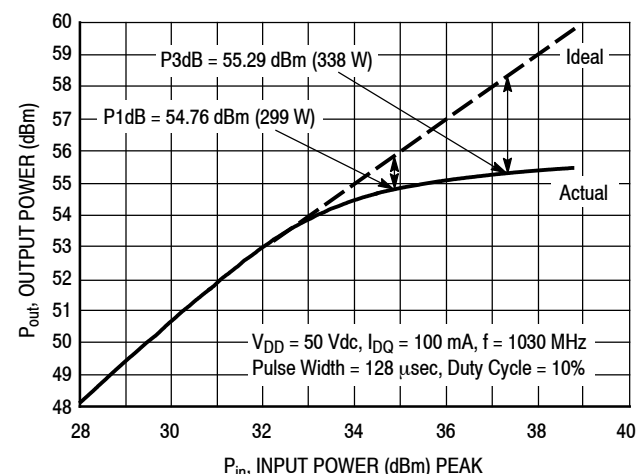

Figure 7. Output Power versus Input Power

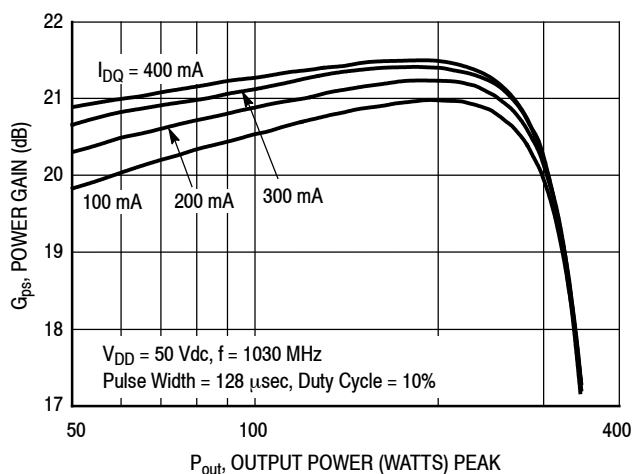

Figure 8. Power Gain versus Output Power

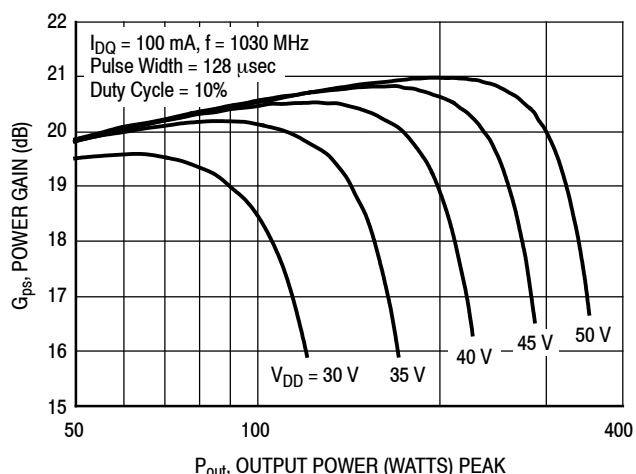

Figure 9. Power Gain versus Output Power

TYPICAL CHARACTERISTICS

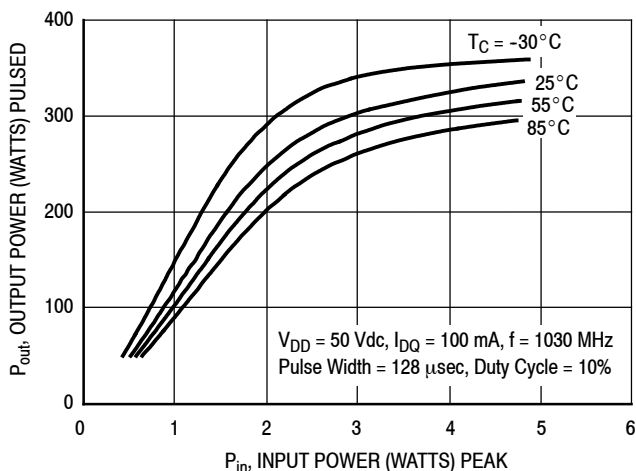

Figure 10. Output Power versus Input Power

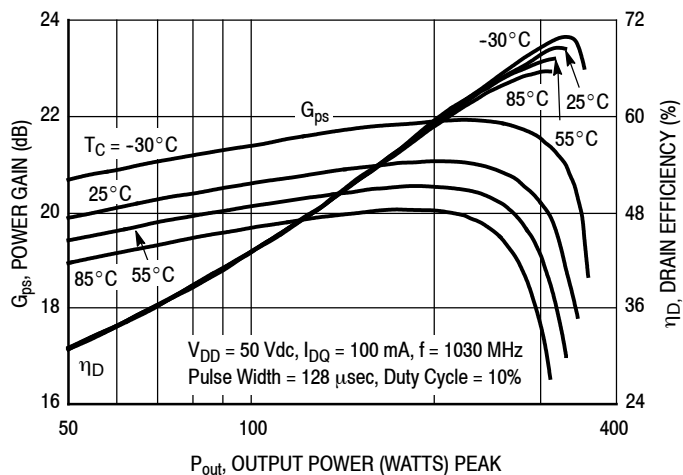
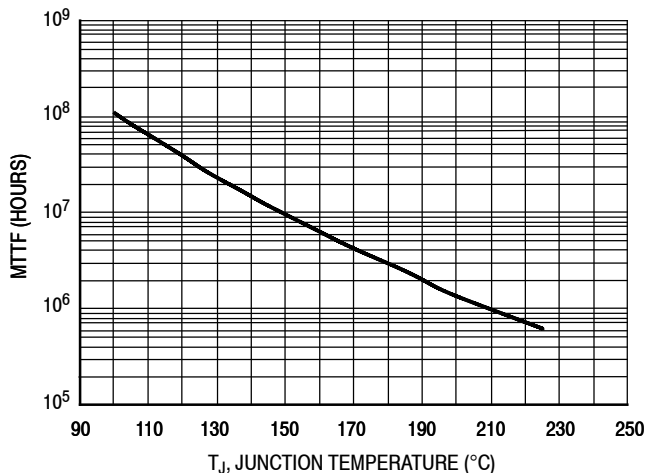
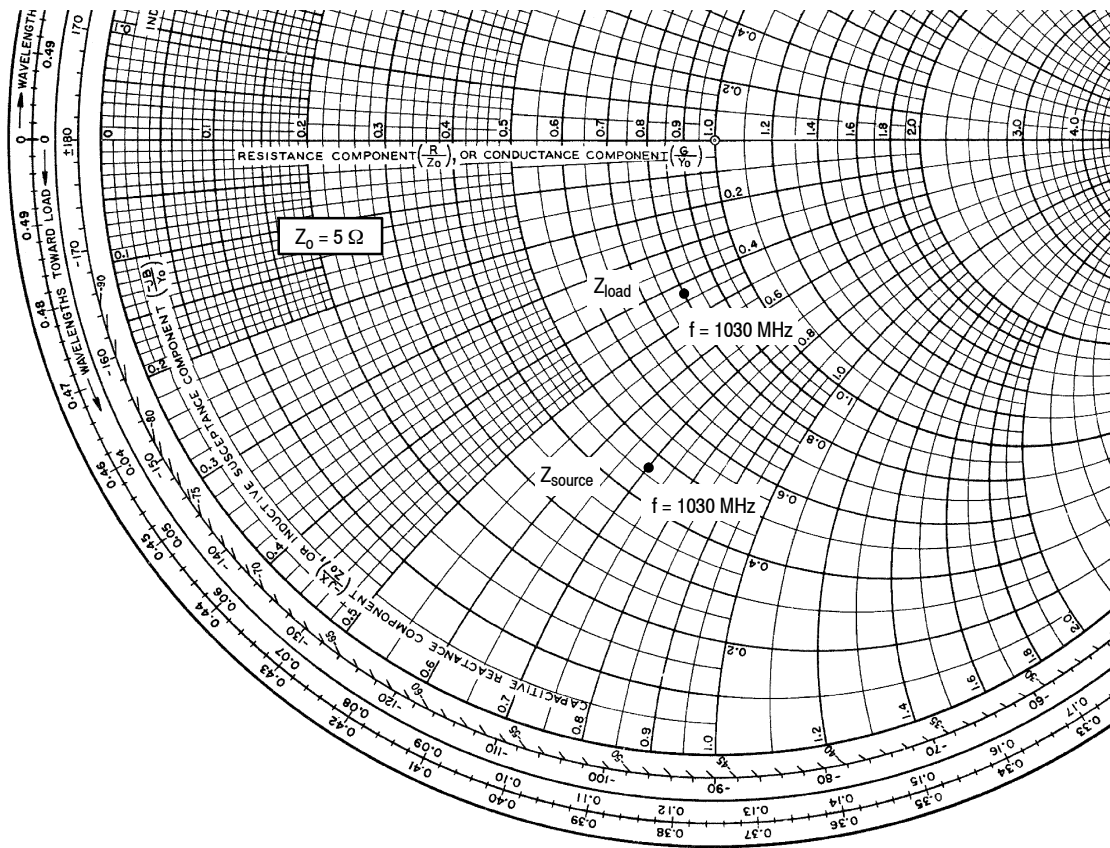

Figure 11. Power Gain and Drain Efficiency versus Output Power



This above graph displays calculated MTTF in hours when the device is operated at $V_{DD} = 50$ Vdc, $P_{out} = 275$ W Peak, Pulse Width = 128 μ sec, Duty Cycle = 10%, and $\eta_D = 65.5\%$.

Figure 12. MTTF versus Junction Temperature — Pulse



f MHz	Z _{source} Ω	Z _{load} Ω
1030	2.30 - j3.51	4.0 - j2.14

Z_{source} = Test circuit impedance as measured from gate to ground.

Z_{load} = Test circuit impedance as measured from drain to ground.

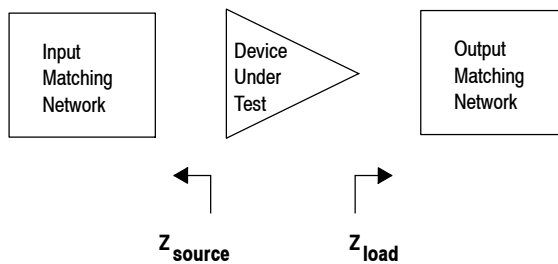

Figure 13. Series Equivalent Source and Load Impedance

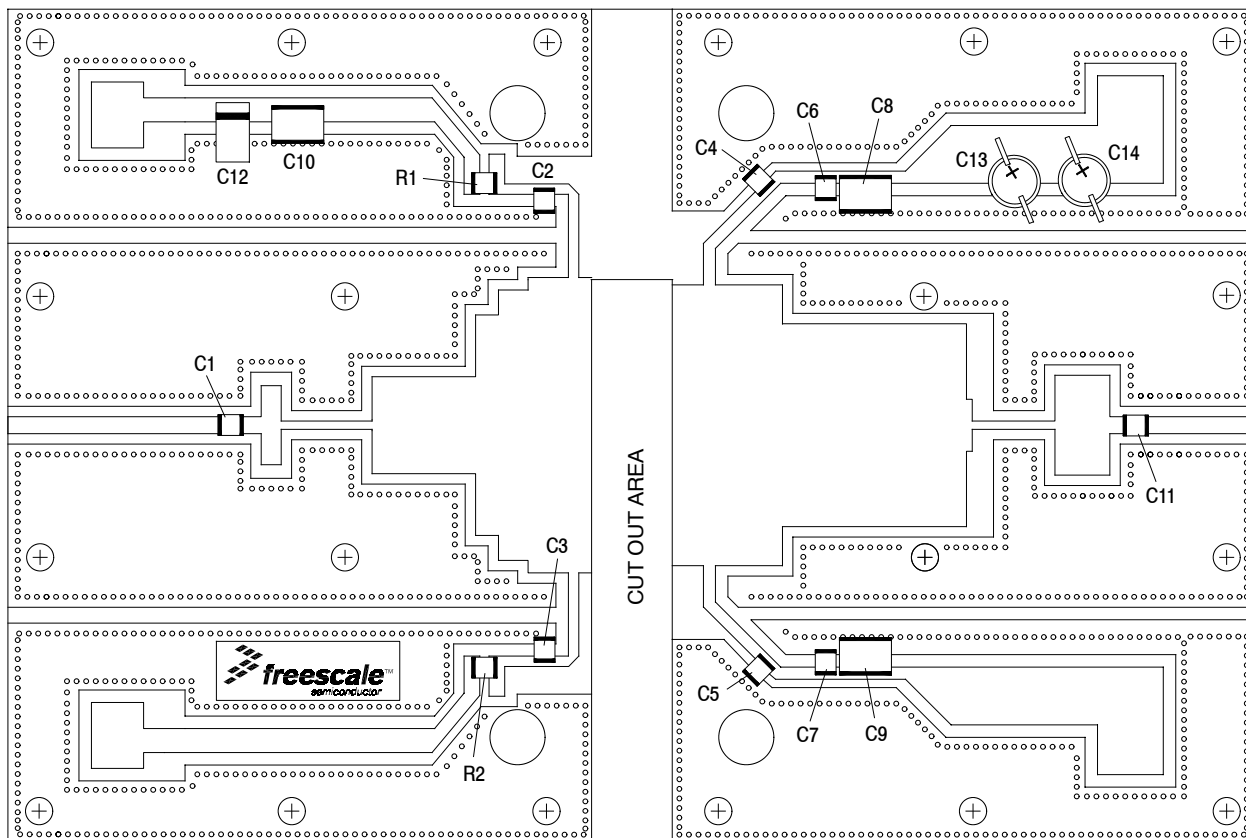

Figure 14. MMRF1008H(HS) Test Circuit Component Layout — 960-1215 MHz

Table 7. MMRF1008H(HS) Test Circuit Component Designations and Values — 960-1215 MHz

Part	Description	Part Number	Manufacturer
C1	2.7 pF Chip Capacitor	ATC100B2R7BT500XT	ATC
C2, C3, C4, C5	33 pF Chip Capacitors	ATC100B330JT500XT	ATC
C6, C7	1000 pF Chip Capacitors	ATC100B102JT50XT	ATC
C8, C9, C10	2.2 μ F, 100 V Chip Capacitors	G2225X7R225KT3AB	ATC
C11	9.1 pF Chip Capacitor	ATC100B9R1CT500XT	ATC
C12	22 μ F, 25 V Tantalum Capacitor	TPSD226M025R0200	AVX
C13, C14	470 μ F, 63 V Electrolytic Capacitors	MCGPR63V477M13X26-RH	Multicomp
R1, R2	47 Ω , 1/4 W Chip Resistors	CRCW120647R0FKEA	Vishay
PCB	0.030", $\epsilon_r = 2.55$	AD255A	Arlon

TYPICAL CHARACTERISTICS — 960-1215 MHz

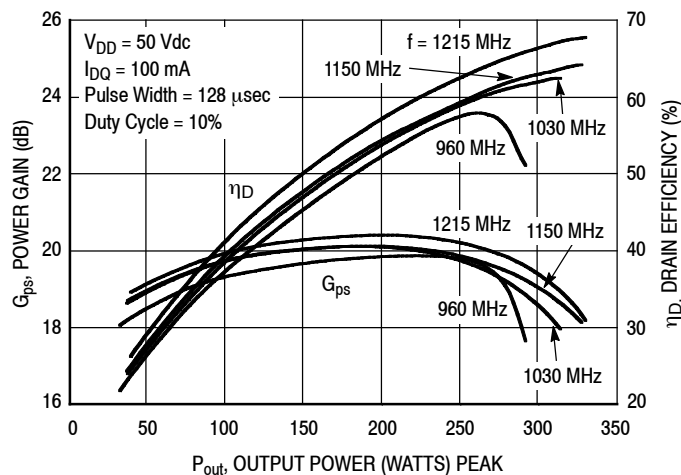

Figure 15. Power Gain and Drain Efficiency versus Output Power

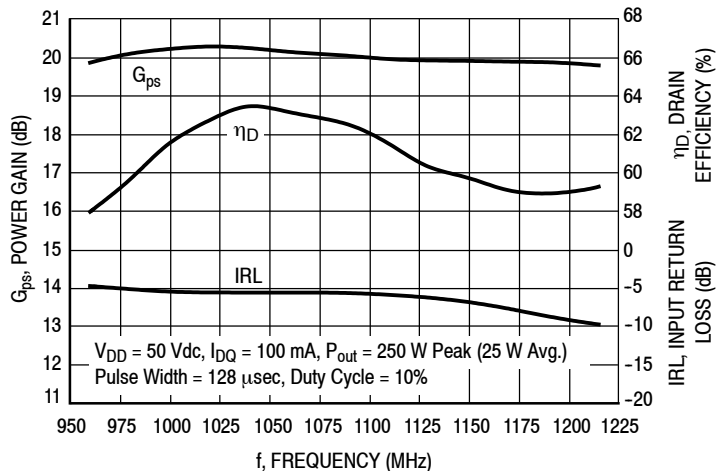
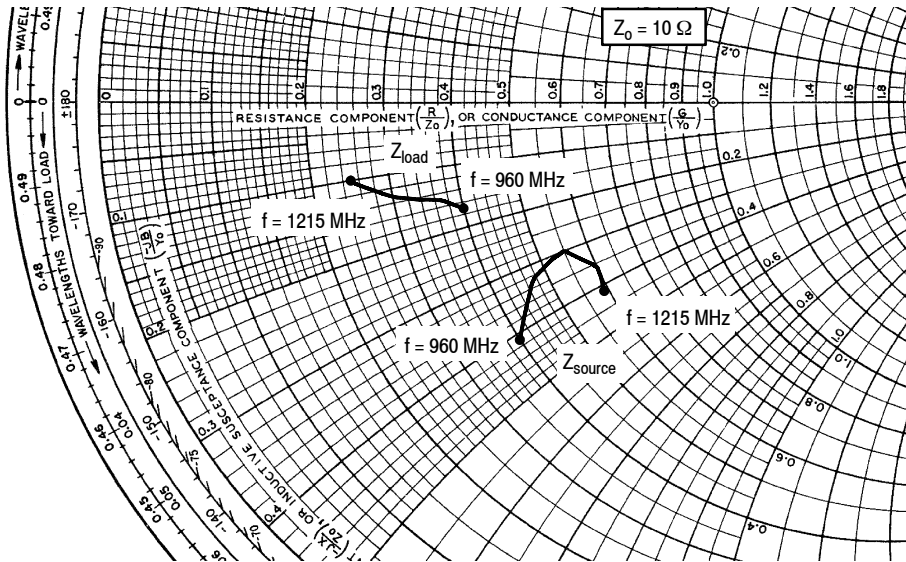

Figure 16. Broadband Performance @ $P_{out} = 250$ Watts Peak



f MHz	Z _{source} Ω	Z _{load} Ω
960	4.00 - j4.14	3.96 - j1.70
970	4.05 - j3.99	3.90 - j1.67
980	4.16 - j3.86	3.83 - j1.66
990	4.33 - j3.71	3.75 - j1.66
1000	4.49 - j3.57	3.70 - j1.65
1010	4.61 - j3.43	3.68 - j1.62
1020	4.66 - j3.33	3.69 - j1.59
1030	4.68 - j3.26	3.69 - j1.54
1040	4.72 - j3.20	3.67 - j1.52
1050	4.83 - j3.13	3.59 - j1.53
1060	5.02 - j3.06	3.48 - j1.53
1070	5.24 - j2.99	3.38 - j1.53
1080	5.42 - j2.96	3.32 - j1.51
1090	5.51 - j2.99	3.30 - j1.47

f MHz	Z _{source} Ω	Z _{load} Ω
1100	5.49 - j3.04	3.32 - j1.43
1110	5.47 - j3.07	3.31 - j1.42
1120	5.52 - j3.09	3.24 - j1.40
1130	5.68 - j3.13	3.12 - j1.39
1140	5.89 - j3.20	2.99 - j1.36
1150	6.06 - j3.32	2.88 - j1.30
1160	6.09 - j3.47	2.83 - j1.23
1170	5.98 - j3.60	2.83 - j1.19
1180	5.85 - j3.69	2.80 - j1.15
1190	5.78 - j3.76	2.75 - j1.11
1200	5.81 - j3.87	2.65 - j1.07
1210	5.89 - j4.02	2.52 - j1.01
1215	5.91 - j4.11	2.47 - j0.97

Z_{source} = Test circuit impedance as measured from gate to ground.

Z_{load} = Test circuit impedance as measured from drain to ground.

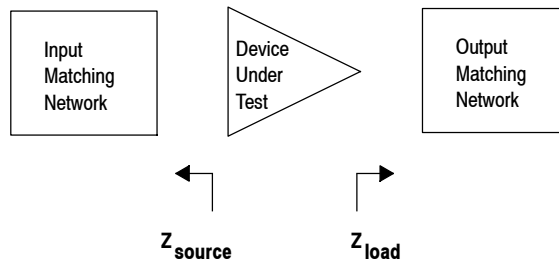
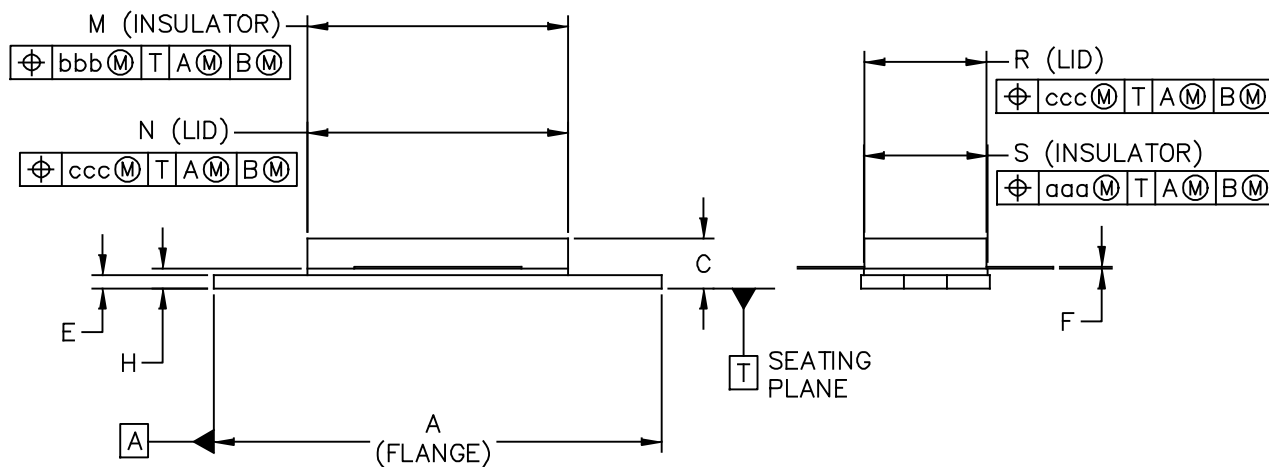
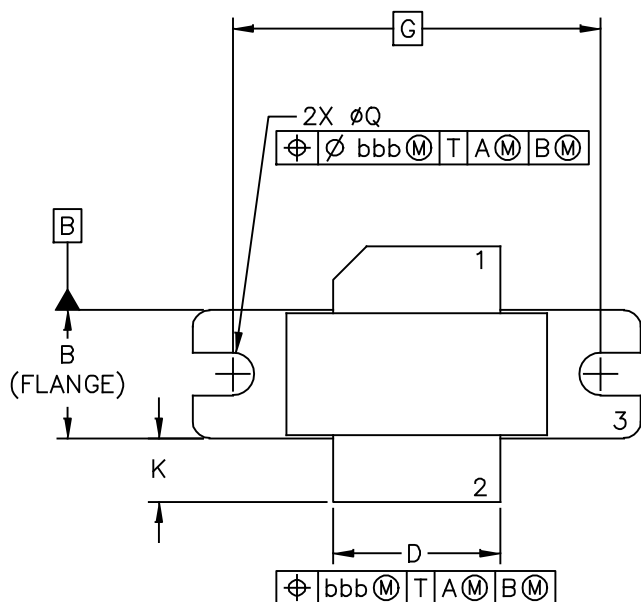

Figure 17. Series Equivalent Source and Load Impedance — 960-1215 MHz

PACKAGE DIMENSIONS



© NXP SEMICONDUCTORS N. V. ALL RIGHTS RESERVED	MECHANICAL OUTLINE	PRINT VERSION NOT TO SCALE
TITLE: NI-780	DOCUMENT NO: 98ASB15607C	REV: H
	STANDARD: NON-JEDEC	
	SOT1792-1	14 MAR 2016

NOTES:

1. DIMENSIONING AND TOLERANCING PER ANSI Y14.5M-1994.
2. CONTROLLING DIMENSION: INCH.
3. DELETED
4. DIMENSION H IS MEASURED .030 (.762) AWAY FROM PACKAGE BODY.

STYLE 1:

- PIN 1. DRAIN
 2. GATE
 3. SOURCE

DIM	INCH		MILLIMETER		DIM	INCH		MILLIMETER	
	MIN	MAX	MIN	MAX		MIN	MAX	MIN	MAX
A	1.335	1.345	33.91	34.16	R	.365	.375	9.27	9.53
B	.380	.390	9.65	9.91	S	.365	.375	9.27	9.52
C	.125	.170	3.18	4.32	aaa	—	.005	—	0.127
D	.495	.505	12.57	12.83	bbb	—	.010	—	0.254
E	.035	.045	0.89	1.14	ccc	—	.015	—	0.381
F	.003	.006	0.08	0.15	—	—	—	—	—
G	1.100 BSC		27.94 BSC		—	—	—	—	—
H	.057	.067	1.45	1.7	—	—	—	—	—
K	.170	.210	4.32	5.33	—	—	—	—	—
M	.774	.786	19.66	19.96	—	—	—	—	—
N	.772	.788	19.6	20	—	—	—	—	—
Q	∅.118	∅.138	∅3	∅3.51	—	—	—	—	—
© NXP SEMICONDUCTORS N.V. ALL RIGHTS RESERVED			MECHANICAL OUTLINE			PRINT VERSION NOT TO SCALE			
TITLE: NI-780					DOCUMENT NO: 98ASB15607C REV: H				
					STANDARD: NON-JEDEC				
					SOT1792-1			14 MAR 2016	

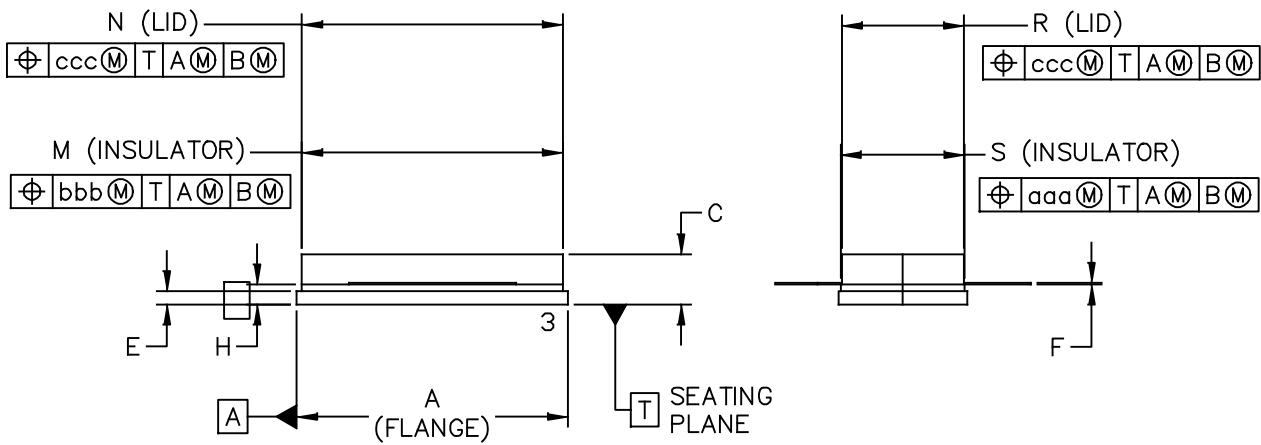
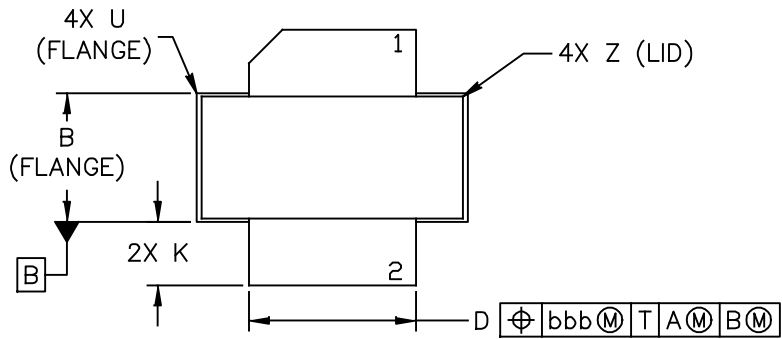

© NXP SEMICONDUCTORS N. V. ALL RIGHTS RESERVED	MECHANICAL OUTLINE	PRINT VERSION NOT TO SCALE
TITLE: NI-780S	DOCUMENT NO: 98ASB16718C	REV: J
	STANDARD: NON-JEDEC	
	SOT1793-1	15 MAR 2016

NOTES:

1. DIMENSIONING AND TOLERANCING PER ANSI Y14.5M-1994.
2. CONTROLLING DIMENSION: INCH.
3. DELETED
4. DIMENSION H IS MEASURED .030 (0.762) AWAY FROM PACKAGE BODY.

STYLE 1:

- PIN 1. DRAIN
2. GATE
3. SOURCE

DIM	INCH		MILLIMETER		DIM	INCH		MILLIMETER	
	MIN	MAX	MIN	MAX		MIN	MAX	MIN	MAX
A	.805	-.815	20.45	20.7	U	-.040	-	-	1.02
B	.380	-.390	9.65	9.91	Z	-.030	-	-	0.76
C	.125	-.170	3.18	4.32	aaa	-.005	-	-	0.127
D	.495	-.505	12.57	12.83	bbb	-.010	-	-	0.254
E	.035	-.045	0.89	1.14	ccc	-.015	-	-	0.381
F	.003	-.006	0.08	0.15	-	-	-	-	-
H	.057	-.067	1.45	1.7	-	-	-	-	-
K	.170	-.210	4.32	5.33	-	-	-	-	-
M	.774	-.786	19.61	20.02	-	-	-	-	-
N	.772	-.788	19.61	20.02	-	-	-	-	-
R	.365	-.375	9.27	9.53	-	-	-	-	-
S	.365	-.375	9.27	9.52	-	-	-	-	-

© NXP SEMICONDUCTORS N.V. ALL RIGHTS RESERVED	MECHANICAL OUTLINE	PRINT VERSION NOT TO SCALE
TITLE: NI-780S	DOCUMENT NO: 98ASB16718C	REV: J
	STANDARD: NON-JEDEC	
	SOT1793-1	15 MAR 2016

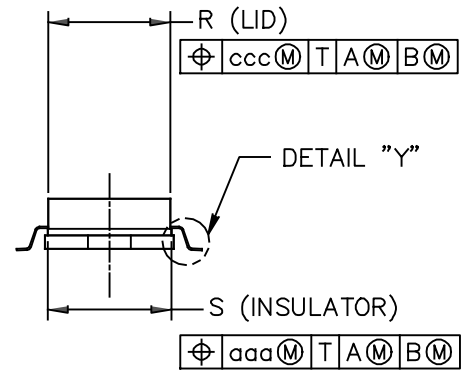
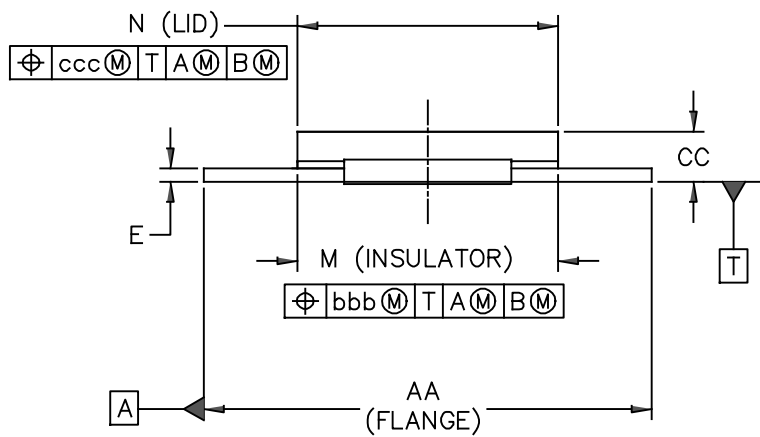
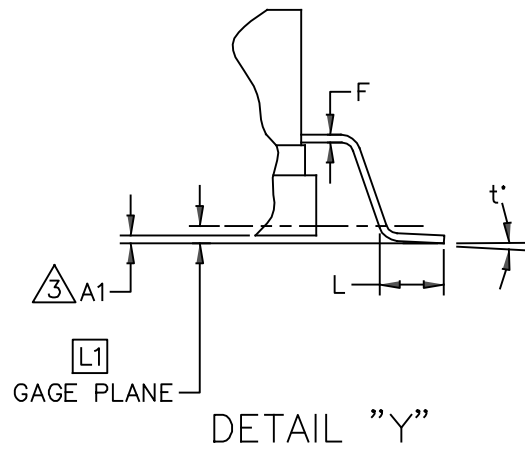
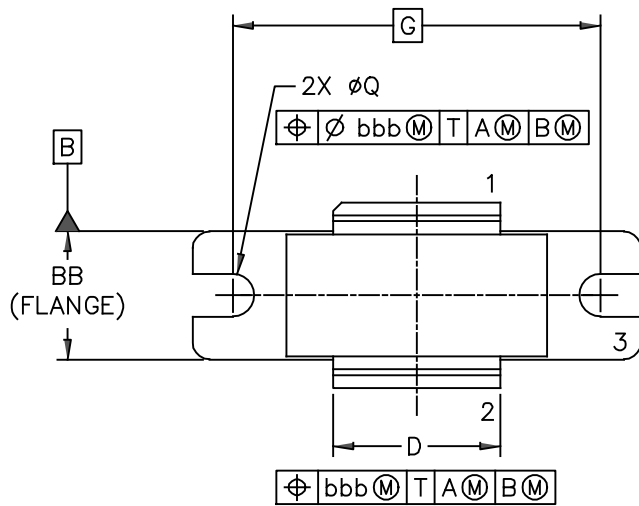

© NXP SEMICONDUCTORS N. V. ALL RIGHTS RESERVED	MECHANICAL OUTLINE	PRINT VERSION NOT TO SCALE
TITLE: NI-780GH-2L	DOCUMENT NO: 98ASA00961D	REV: 0
	STANDARD: NON-JEDEC	
	SOTxxxx	11 FEB 2016

NOTES:

1. DIMENSIONING AND TOLERANCING PER ANSI Y14.5M-1994.
2. CONTROLLING DIMENSION: INCH.

3. DIMENSION A1 MEASURED WITH REFERENCE TO DATUM T. THE POSITIVE VALUE IMPLIES THAT THE PACKAGE BOTTOM IS HIGHER THAN THE LEAD BOTTOM. TOLERANCE ON DIMENSION A1 IS TENTATIVE. WILL BE FINALIZED AT PACKAGE CERTIFICATION.

DIM	INCH		MILLIMETER		DIM	INCH		MILLIMETER	
	MIN	MAX	MIN	MAX		MIN	MAX	MIN	MAX
AA	1.335	1.345	33.91	34.16	N	.772	.788	19.60	20.02
BB	.380	.390	9.65	9.91	Q	∅.118	∅.138	∅3.00	∅3.51
CC	.125	.170	3.18	4.32	R	.365	.375	9.27	9.53
A1	.002	.008	0.05	0.20	S	.365	.375	9.27	9.53
B1	.546	.562	13.87	14.27	t*	0*	8*	0*	8*
D	.495	.505	12.57	12.83	aaa		.005		0.13
E	.035	.045	0.89	1.14	bbb		.010		0.25
F	.003	.006	0.08	0.15	ccc		.015		0.38
G	1.100 BSC		27.94 BSC						
L	.038	.046	0.97	1.17					
L1	.010 BSC		0.25 BSC						
M	.774	.786	19.66	19.96					
© NXP SEMICONDUCTORS N.V. ALL RIGHTS RESERVED			MECHANICAL OUTLINE			PRINT VERSION NOT TO SCALE			
TITLE: NI-780GH-2L					DOCUMENT NO: 98ASA00961D REV: 0				
					STANDARD: NON-JEDEC				
					SOTxxxx			11 FEB 2016	

PRODUCT DOCUMENTATION

Refer to the following documents to aid your design process.

Application Notes

- AN1955: Thermal Measurement Methodology of RF Power Amplifiers

Engineering Bulletins

- EB212: Using Data Sheet Impedances for RF LDMOS Devices

REVISION HISTORY

The following table summarizes revisions to this document.

Revision	Date	Description
0	Dec. 2013	<ul style="list-style-type: none">• Initial Release of Data Sheet
1	May 2016	<ul style="list-style-type: none">• Added part number MMRF1008GH, p. 1• Added NI-780GH-2L package photo, p. 1, and Mechanical Outline, pp. 16-17• Added Fig. 1, Pin Connections, p. 1• Table 5, Ordering Information: tape and reel information, p. 1, placed in Ordering Information table, p. 3

How to Reach Us:

Home Page:
freescale.com

Web Support:
freescale.com/support

Information in this document is provided solely to enable system and software implementers to use Freescale products. There are no express or implied copyright licenses granted hereunder to design or fabricate any integrated circuits based on the information in this document.

Freescale reserves the right to make changes without further notice to any products herein. Freescale makes no warranty, representation, or guarantee regarding the suitability of its products for any particular purpose, nor does Freescale assume any liability arising out of the application or use of any product or circuit, and specifically disclaims any and all liability, including without limitation consequential or incidental damages. "Typical" parameters that may be provided in Freescale data sheets and/or specifications can and do vary in different applications, and actual performance may vary over time. All operating parameters, including "typicals," must be validated for each customer application by customer's technical experts. Freescale does not convey any license under its patent rights nor the rights of others. Freescale sells products pursuant to standard terms and conditions of sale, which can be found at the following address: freescale.com/SalesTermsandConditions.

Freescale and the Freescale logo are trademarks of Freescale Semiconductor, Inc., Reg. U.S. Pat. & Tm. Off. All other product or service names are the property of their respective owners.

© 2013, 2016 Freescale Semiconductor, Inc.

