

# SRUK208x Series

RoHS

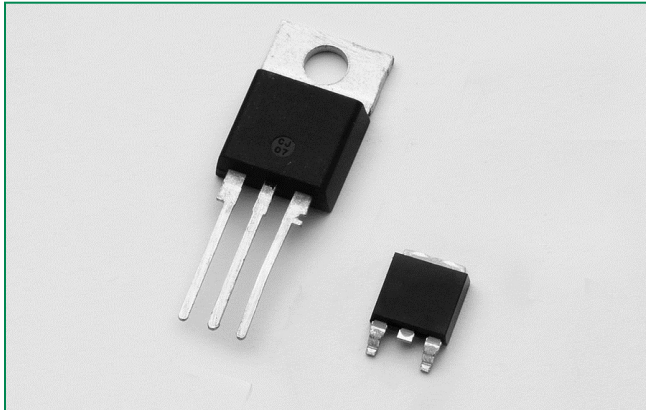

## Description

The SRUK208x SCR series is specifically designed for high voltage capacitor discharge application

## Features & Benefits

- High forward blocking voltage of 1200V
- High pulse current handling capability
- High di/dt of 350A/μs
- Reverse direction not design to function

## Main Features

Symbol	Value	Unit
$I_{T(RMS)}$	8	A
$V_{DRM}$	1200	V
$V_{RRM}$	N/A	V
$I_{GT}$	15	mA

## Applications

Typical applications are high voltage pulse generation by capacitor discharge for electric fences, CEWs (contact electric weapon) and high-power strobe lights.

## Schematic Symbol

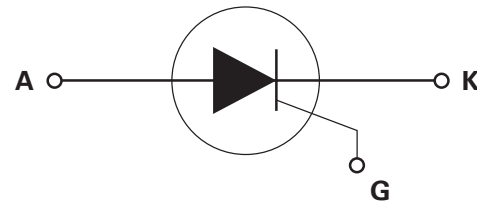

## Absolute Maximum Ratings – Standard SCRs

Symbol	Parameter	Test Conditions	Value	Unit
$V_{DSM}$	Non-repetitive peak off-state voltage	$T_J = 25^\circ\text{C}$	1400	V
$I_{T(RMS)}$	RMS on-state current	SRUK208R $T_C = 105^\circ\text{C}$	8	A
$I_{T(AV)}$	Average on-state current	SRUK208D $T_C = 110^\circ\text{C}$	5.1	A
$I_{TSM}$	Peak non-repetitive surge current	single half cycle; $f = 50\text{Hz}$ ; $T_J$ (initial) = $25^\circ\text{C}$	83	A
		single half cycle; $f = 60\text{Hz}$ ; $T_J$ (initial) = $25^\circ\text{C}$	100	
$I_{TRM}$	Peak Repetitive Pulse Current	Double-exponential, $1.7\mu\text{s} \times 7\mu\text{s}$ , $f = 44\text{Hz}$ , $T_A = 50^\circ\text{C}$	400	A
$I^2t$	$I^2t$ Value for fusing	$t_p = 8.3\text{ ms}$	41	$\text{A}^2\text{s}$
di/dt	Critical rate-of-rise of on-state current	$T_J = 50^\circ\text{C}$	350	$\text{A}/\mu\text{s}$
$I_{GM}$	Peak gate current	$T_p = 10\mu\text{s}$ , $T_J = 125^\circ\text{C}$	3	A
$P_{G(AV)}$	Average gate power dissipation	$T_J = 125^\circ\text{C}$	0.5	W
$T_{stg}$	Storage temperature range		-40 to 150	$^\circ\text{C}$
$T_J$	Operating junction temperature range		-40 to 125	$^\circ\text{C}$

**Electrical Characteristics ( $T_J = 25^\circ\text{C}$ , unless otherwise specified)**

Symbol	Test Conditions		Value	Unit
$I_{GT}$	$V_D = 12\text{V}$ $R_L = 60\ \Omega$	MIN.	5	mA
		MAX.	15	
$V_{GT}$		MAX.	1.5	V
dv/dt	$V_D = V_{DRM}$ ; gate open; $T_J = 125^\circ\text{C}$	MIN.	100	V/ $\mu\text{s}$
$V_{GD}$	$V_D = V_{DRM}$ $R_L = 3.3\ \text{k}\Omega$ $T_J = 125^\circ\text{C}$	MIN.	0.2	V
$I_H$	$I_T = 200\text{mA}$ (initial)	MIN.	10	mA
		MAX.	30	
$t_q$	$I_T = 0.5\text{A}$ ; $t_p = 50\ \mu\text{s}$ ; $dv/dt = 5\text{V}/\mu\text{s}$ ; $di/dt = -30\text{A}/\mu\text{s}$	TYP.	40	$\mu\text{s}$
$t_{gt}$	$I_G = 2 \times I_{GT}$ $PW = 15\ \mu\text{s}$ $I_T = 16\text{A}$	TYP.	1	$\mu\text{s}$

**Static Characteristics**

Symbol	Test Conditions		Value	Unit	
$V_{TM}$	$I_T = 16\text{A}$ ; $t_p = 380\ \mu\text{s}$	MAX.	1.6	V	
$I_{DRM}$	$V_{DRM}$	$T_J = 25^\circ\text{C}$	MAX.	10	$\mu\text{A}$
		$T_J = 125^\circ\text{C}$		4	mA

**Thermal Resistances**

Symbol	Parameter		Value	Unit
$R_{\theta(J-C)}$	Junction to case (AC)	SRUK208R	1.8	$^\circ\text{C}/\text{W}$
		SRUK208D	1.5	

**Figure 1: Normalized DC Gate Trigger Current vs. Junction Temperature**

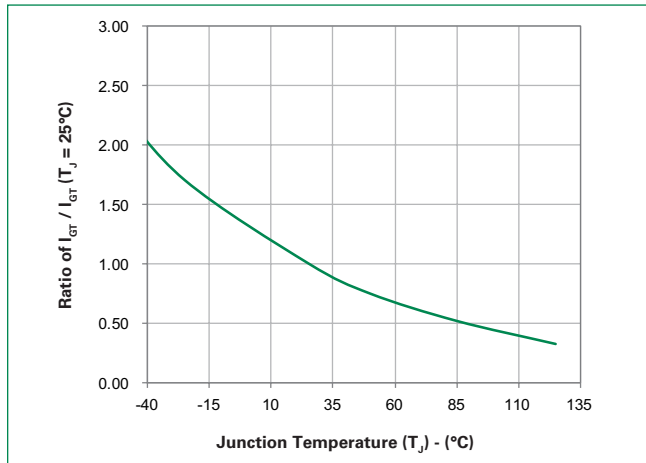

**Figure 2: Normalized DC Gate Trigger Voltage vs. Junction Temperature**

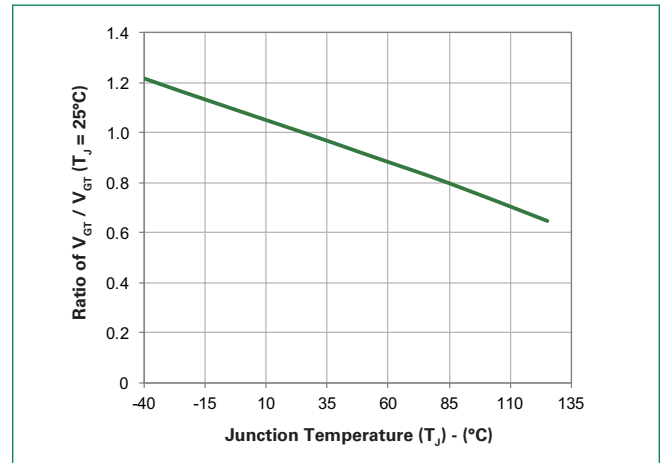

**Figure 3: Normalized DC Holding Current vs. Junction Temperature**

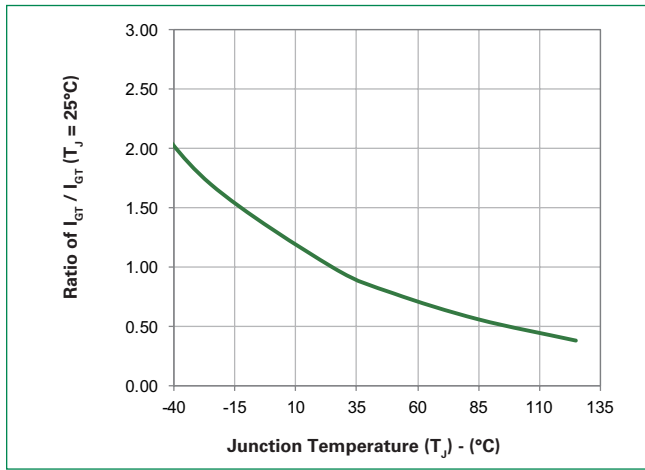

**Figure 4: On-State Current vs. On-State Voltage (Typical)**

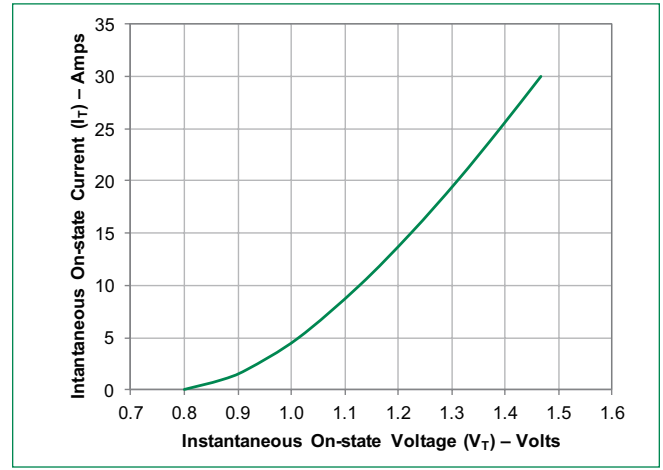

**Figure 5: Power Dissipation (Typical) vs. RMS On-State Current**

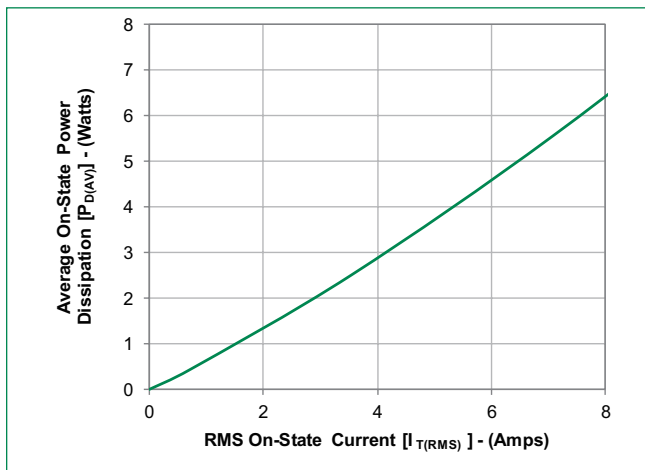

**Figure 6: Maximum Allowable Case Temperature vs. RMS On-State Current**

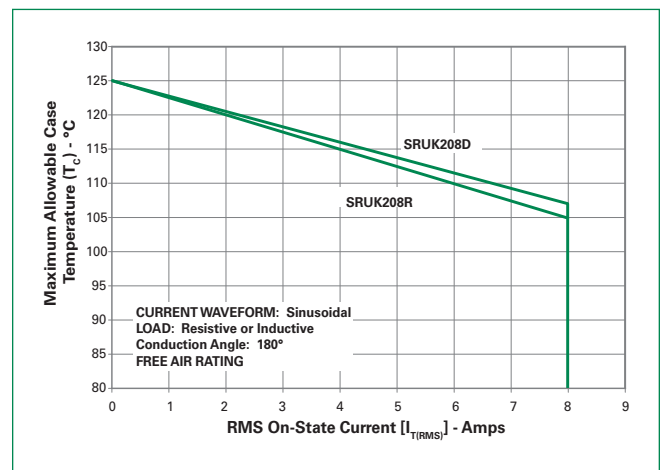

**Figure 7: Maximum Allowable Case Temperature vs. Average On-State Current**

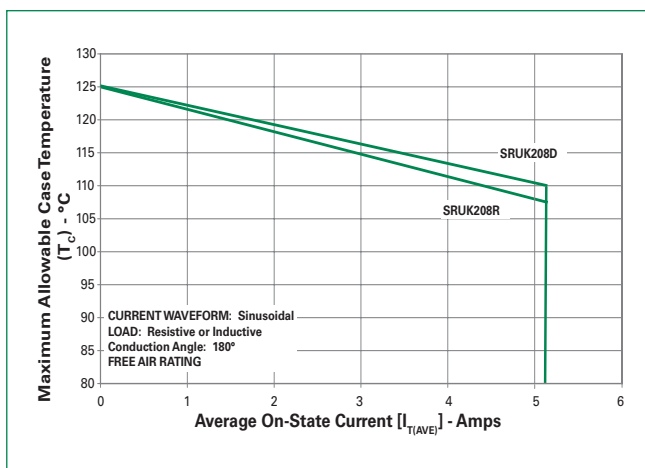

**Figure 8: Peak Capacitor Discharge Current**

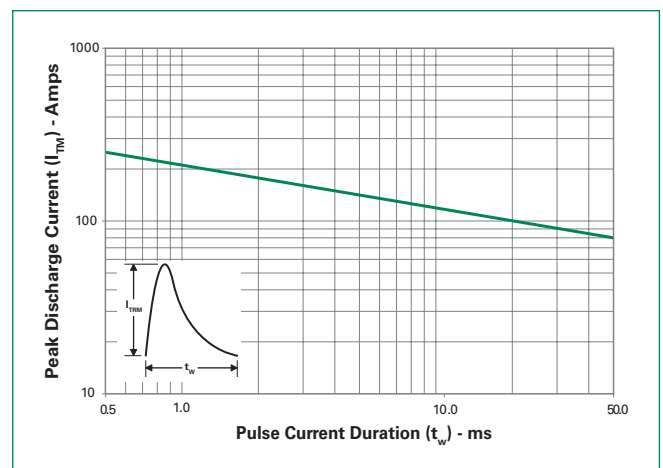

**Figure 9: Peak Capacitor Discharge Current Derating**

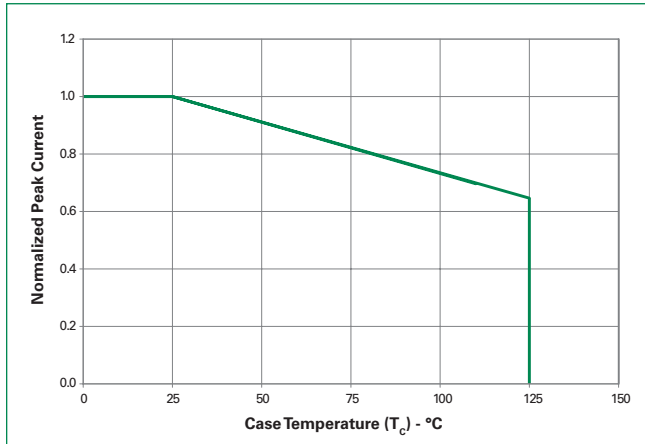

**Figure 10: Surge Peak On-State Current vs. Number of Cycles**

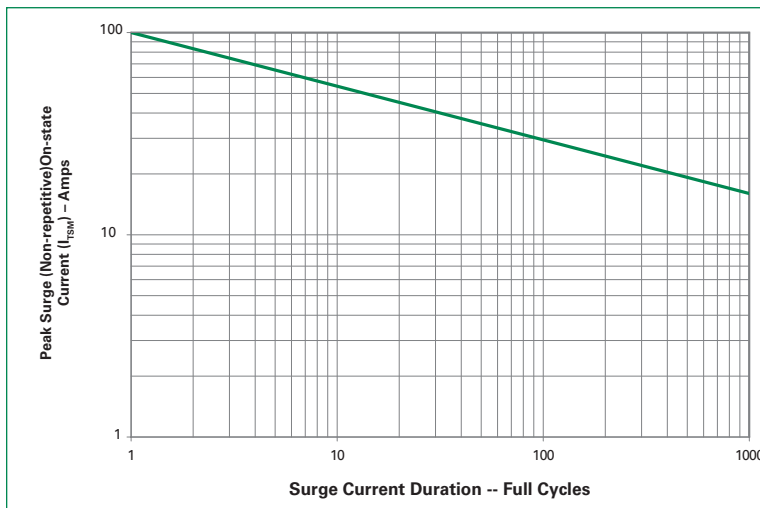

SUPPLY FREQUENCY: 60 Hz Sinusoidal  
LOAD: Resistive  
RMS On-State Current: [ $I_{T(RMS)}$ ]: Maximum Rated Value at Specified Case Temperature

- Notes:
1. Gate control may be lost during and immediately following surge current interval.
  2. Overload may not be repeated until junction temperature has returned to steady-state rated value.

**Soldering Parameters**

Reflow Condition	Pb – Free assembly	
Pre Heat	- Temperature Min ( $T_{s(min)}$ )	150°C
	- Temperature Max ( $T_{s(max)}$ )	200°C
	- Time (min to max) ( $t_s$ )	60 – 180 secs
Average ramp up rate (Liquidus Temp ( $T_L$ ) to peak)	5°C/second max	
$T_{s(max)}$ to $T_L$ - Ramp-up Rate	5°C/second max	
Reflow	- Temperature ( $T_L$ ) (Liquidus)	217°C
	- Time ( $t_L$ )	60 – 150 seconds
Peak Temperature ( $T_p$ )	260 <sup>+0/-5</sup> °C	
Time within 5°C of actual peak Temperature ( $t_p$ )	20 – 40 seconds	
Ramp-down Rate	5°C/second max	
Time 25°C to peak Temperature ( $T_p$ )	8 minutes Max.	
Do not exceed	280°C	

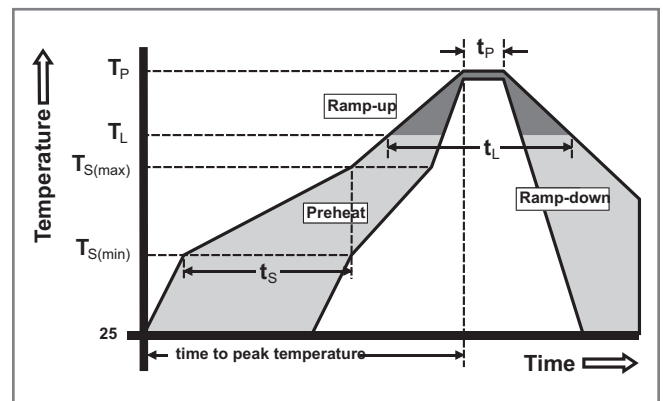

**Physical Specifications**

<b>Terminal Finish</b>	100% Matte Tin-plated
<b>Body Material</b>	UL Recognized epoxy meeting flammability rating V-0
<b>Lead Material</b>	Copper Alloy

**Design Considerations**

Careful selection of the correct component for the application's operating parameters and environment will go a long way toward extending the operating life of the Thyristor. Good design practice should limit the maximum continuous current through the main terminals to 75% of the component rating. Other ways to ensure long life for a power discrete semiconductor are proper heat sinking and selection of voltage ratings for worst case conditions. Overheating, overvoltage (including dv/dt), and surge currents are the main killers of semiconductors. Correct mounting, soldering, and forming of the leads also help protect against component damage.

**Environmental Specifications**

Test	Specifications and Conditions
<b>AC Blocking</b>	Rectified Peak AC voltage@125°C for 96 hours
<b>DC Blocking</b>	96hours; DC 1200V@85°C
<b>Temperature/Humidity</b>	96hours; 320V –DC; 85°C 85% rel humidity
<b>Temperature Cycling</b>	100cycles; -40°C to +125°C; 15-min dwell-time
<b>Resistance to Solder Heat</b>	MIL-STD-750 Method 2031
<b>Solderability</b>	ANSI/J-STD-002, category 3, Test A

**Dimensions — TO-220AB (R-Package) — Non-Isolated Mounting Tab Common with Center Lead**

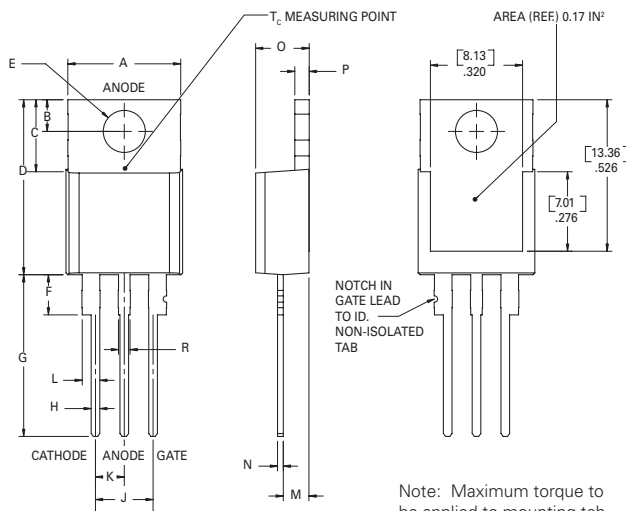

Dimension	Inches		Millimeters	
	Min	Max	Min	Max
A	0.380	0.420	9.65	10.67
B	0.105	0.115	2.67	2.92
C	0.230	0.250	5.84	6.35
D	0.590	0.620	14.99	15.75
E	0.142	0.147	3.61	3.73
F	0.110	0.130	2.79	3.30
G	0.540	0.575	13.72	14.61
H	0.025	0.035	0.64	0.89
J	0.195	0.205	4.95	5.21
K	0.095	0.105	2.41	2.67
L	0.060	0.075	1.52	1.91
M	0.085	0.095	2.16	2.41
N	0.018	0.024	0.46	0.61
O	0.178	0.188	4.52	4.78
P	0.045	0.060	1.14	1.52
R	0.038	0.048	0.97	1.22

**Dimensions — TO-252AA (D-Package) — D-PAK Surface Mount**

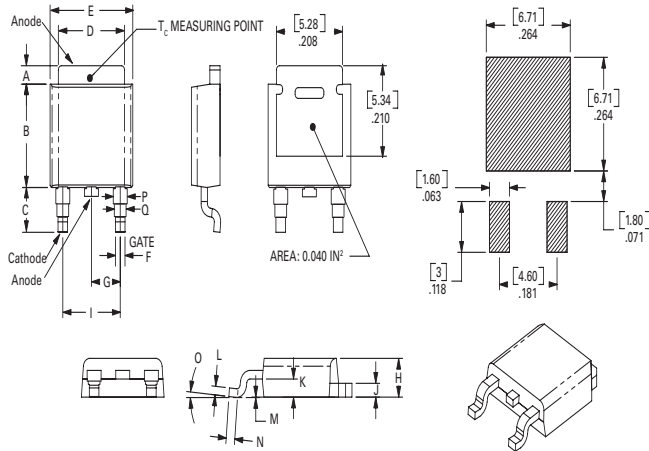

Dimension	Inches			Millimeters		
	Min	Typ	Max	Min	Typ	Max
A	0.037	0.040	0.043	0.94	1.01	1.09
B	0.235	0.243	0.245	5.97	6.16	6.22
C	0.106	0.108	0.113	2.69	2.74	2.87
D	0.205	0.208	0.213	5.21	5.29	5.41
E	0.255	0.262	0.265	6.48	6.65	6.73
F	0.027	0.031	0.033	0.69	0.80	0.84
G	0.087	0.090	0.093	2.21	2.28	2.36
H	0.085	0.092	0.095	2.16	2.33	2.41
I	0.176	0.179	0.184	4.47	4.55	4.67
J	0.018	0.020	0.023	0.46	0.51	0.58
K	0.035	0.037	0.039	0.90	0.95	1.00
L	0.018	0.020	0.023	0.46	0.51	0.58
M	0.000	0.000	0.004	0.00	0.00	0.10
N	0.021	0.026	0.027	0.53	0.67	0.69
O	0°	0°	5°	0°	0°	5°
P	0.042	0.047	0.052	1.06	1.20	1.32
Q	0.034	0.039	0.044	0.86	1.00	1.11

**Packing Options**

Part Number	Marking	Package	Type	Weight	Packing Mode	Base Quantity
SRUK208RTP	SRUK208R	TO-220R	Standard SCR	2.2 g	Tube	500
SRUK208DRP	SRUK208D	TO-252	Standard SCR	0.3 g	Embossed Carrier	2500

**Part Numbering System**

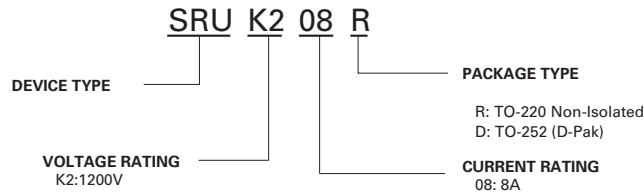

**Part Marking System**

TO-220 AB - (R Package)    TO-252AA - (D Package)

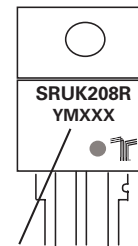

Date Code Marking  
 Y: Year Code  
 M: Month Code  
 XXX: Lot Trace Code

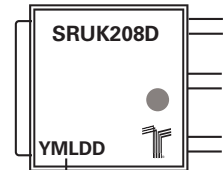

Date Code Marking  
 Y: Year Code  
 M: Month Code  
 L: Location Code  
 DD: Calendar Code

**TO-252 Embossed Carrier Reel Pack (RP) Specifications**

**Meets all EIA-481-2 Standards**

